

Linking technology choice with operation and maintenance in the context of community water supply and sanitation

**A REFERENCE DOCUMENT
FOR PLANNERS AND PROJECT STAFF**

François Brikké and Maarten Bredero



World Health Organization and IRC Water and Sanitation Centre
Geneva, Switzerland

2003

Contents

Preface	v
Acknowledgements	vi
1. Introduction	1
1.1 The importance of operation and maintenance for water-supply and sanitation technologies	1
1.2 Defining sustainability	2
1.3 Organization of the document – Fact Sheets	5
2. The technology selection process	6
2.1 Introduction	6
2.2 Factors that influence the selection of community water-supply technology	6
2.3 The selection process for community water-supply technology	8
2.4 Factors that influence the selection of community sanitation technology	10
2.5 The selection process for community sanitation technology	10
2.6 Assessing O&M needs	12
3. Water sources and intakes	20
3.1 Introduction	20
3.2 Rooftop rainwater harvesting	21
3.3 Catchment and storage dams	23
3.4 Springwater collection	26
3.5 Dug well	29
3.6 Drilled wells	32
3.7 Subsurface harvesting systems	34
3.8 Protected side intake	36
3.9 River-bottom intake	38
3.10 Floating intake	39
3.11 Sump intake	41
4. Water-lifting devices	43
4.1 Introduction	43
4.2 Rope and bucket	43
4.3 Bucket pump	45
4.4 Rope pump	47
4.5 Suction plunger handpump	49
4.6 Direct action handpump	51
4.7 Deep-well diaphragm pump	53
4.8 Deep-well piston handpump	55
4.9 Centrifugal pump	58
4.10 Submersible pump	60
4.11 Hydraulic ram pump	62
5. Power systems	64
5.1 Introduction	64
5.2 Windmills	64
5.3 Solar power system	66
5.4 Diesel generator	68

6. Water treatment	71
6.1 Introduction	71
6.2 Boiling	75
6.3 Household slow sand filter	77
6.4 Water chlorination at household level	79
6.5 Storage and sedimentation	81
6.6 Upflow roughing filter	82
6.7 Slow sand filtration	84
6.8 Chlorination in piped systems	
7. Storage and distribution	90
7.1 Introduction	90
7.2 Concrete-lined earthen reservoir	91
7.3 Reinforced concrete reservoir	93
7.4 Elevated steel reservoir	94
7.5 Ferrocement tank	96
7.6 Public standpost	98
7.7 Domestic connection	100
7.8 Domestic water meter	
8. Sanitation	103
8.1 Introduction	103
8.2 Improved traditional pit latrine	105
8.3 Ventilated improved pit latrine	108
8.4 Double-vault compost latrine	111
8.5 Bored-hole latrine	113
8.6 Pour-flush latrine	114
8.7 Septic tank and aqua privy	117
8.8 Vacuum tanker	119
8.9 Manual pit emptying technology (MAPET)	122
8.10 Soakaway	124
8.11 Drainage field	125
8.12 Small-bore sewerage system	126
9. Bibliography	129

Preface

The *Global Water Supply and Sanitation Assessment 2000*, a report prepared jointly by the World Health Organization (WHO) and the United Nations Children's Fund (UNICEF), indicated that nearly 1.1 billion (1100 million) people have no access to improved water sources and that about 2.4 billion have no access to any form of improved sanitation facilities, with the vast majority of these people living in developing countries. To achieve the international development target of halving the percentage of people without access to improved water supply or sanitation by the year 2015, an additional 1.6 billion people will require access to water supply and about 2.2 billion will require access to sanitation facilities by 2015, given the projected population increases. The task is huge and involves a considerable increase in the level of investments made so far.

A major concern for expanding water-supply and sanitation services is to select technologies and institutional options that users would be willing to pay for, and that would also ensure good public health and sustainable environmental conditions. As suggested by its title, the present document aims to help decision-makers identify the most appropriate technology for their situation, taking into account the conditions in the project area. The document focuses on developing countries, and provides essential information on the types of water-supply and sanitation technologies available, including descriptions of the operation and maintenance requirements of the technologies, the actors involved and the skills they must have or must acquire. It also addresses potential problems, including those that have been identified in prior water-supply and sanitation projects.

It is hoped that this contribution to sector development will be useful to bilateral, multilateral and governmental agencies that are involved in choosing the water-supply and sanitation technologies to be used in specific situations. The current document is a revision of a previous version that was based on the results of several years of field-testing different technologies and was prepared by the Operation and Maintenance Working Group of the Water Supply and Sanitation Collaborative Council (c/o WHO).

José Hueb
World Health Organization

Acknowledgements

This document is a revised version of a 1997 document. It has been prepared under the guidance of the Operation and Maintenance Network of the Water Supply and Sanitation Collaborative Council. Valuable advice and suggestions were given by all members of this network, especially José Hueb, the former Operation and Maintenance Network Coordinator, who coordinated the development of this manual.

The IRC International Water and Sanitation Centre undertook the preparation of this document, with professional inputs mainly from François Brikké and Maarten Bredero, supported by Catarina Fonseca, Tom de Veer, Jo Smet, Madeleen Wegelin and Jan Teun Visscher. Several manufacturers (e.g. of the Vergnet pump) and specialists also gave advice, including Jamie Bartram (WHO, Geneva), Rhonda Bower (SOPAC, Fiji), Carmelo Gendrano (Philippine Centre for Water and Sanitation, Philippines), Louise Halestrap (CAT, United Kingdom), Hans Hartung (FAKT, Germany), Patrick Kilchenmann (SKAT, Switzerland), Hilmy Sally (International Water Management Institute, Sri Lanka), Kate Skinner (Mvula, South Africa), Felipe Solzona (CEPIS, Peru), Terry Thomas (DTU, United Kingdom), Claude Toutant (International Water Office Headquarters, France). Malcolm Farley (Malcom Farley Associates, England) should be especially thanked for his excellent comments to the final draft. The drawings were prepared by Marjan Bloem.

Special thanks are due to the Directorate-General for Development Cooperation, Ministry of Foreign Affairs of the Government of Italy, and the Directorate-General for International Cooperation, Government of The Netherlands, for their financial contribution towards the preparation of this project.

1. Introduction

1.1 The importance of operation and maintenance for water-supply and sanitation technologies

In many developing countries, operation and maintenance (O&M) of small, community water-supply and sanitation systems has been neglected. Sanitation, in particular, is given much less attention in practice, even though “water-supply and sanitation improvements” are often mentioned together in project documents. This has led to some alarming statistics, with an estimated 30%–60% of existing rural water-supply systems inoperative at any given time, and more than 2 billion people worldwide lacking access to any type of improved sanitation. The lack of such services is degrading for the affected people and has a serious impact on their health and well-being.

Increasingly, however, governments, external support agencies and local communities are recognizing the importance of integrating O&M components in all development phases of water-supply and sanitation projects, including the planning, implementation, management, and monitoring phases. National government plays a vital role in creating an “enabling environment” within which an O&M policy framework can be developed, one of the key elements of sustainability. Government can foster such an environment in a number of ways, including through legal provisions, regulations, education initiatives and training programmes, and by communicating information. If supportive O&M policy is not forthcoming from the central government, then support for O&M at the local level will be hindered. An important role of local government is to promote an awareness of national policies and to support community water-user committees. Both the project staff and the recipient communities should be made aware of the O&M implications, as the communities themselves have responsibilities in the management and O&M of their water-supply and sanitation systems. However, many local government departments have insufficient resources and are unable to provide effective support. Support by the local government may also be influenced by local politics.

The roles and responsibilities of the actors involved in O&M need to be well defined, especially where governments are shifting from their traditional role as a services provider to that of a facilitator of service provision. There has been a tendency to decentralize O&M activities and to encourage the private sector to get involved in both the construction and upkeep of water-supply and sanitation facilities. Although this trend could increase the flexibility of O&M activities and reduce costs, private sector involvement may be limited by the low profit margins, particularly in areas where rural communities are scattered. Private-sector accountability is also a concern when there are no controls or regulations. Communities that contract services from the private sector need to ensure that the job is well done at a fair price. To some extent, the communities themselves can monitor the quality of the work, even though they may initially require assistance from the central government (e.g. from the national water agency). Nevertheless, informal community-based monitoring is no substitute for developing government guidelines to ensure there are minimum-quality standards for the work, and that interventions are cost-effective. It is also important that the guidelines be conveyed to the communities, since they have increasing responsibilities, not only in the O&M of their

water-supply systems, but also in their financial management. Regulation, control and monitoring require extensive efforts and commitment by governments, and considerable human and financial resources.

Sector professionals use a number of terms to describe affordable, simple technologies that can be adapted to local conditions and be maintained by the communities themselves. Such terms include: appropriate technology, progressive technology, alternative technology, village-level operation and maintenance management (VLOM) technology, intermediate technology, village technology, low-cost technology, self-help technology, technology with a human face. In this document, we propose to use the term “sustainable technology at community level”, since this encompasses precisely the aims of this publication. Water-supply and sanitation projects should not be viewed as an end in themselves, but as the initiators of benefits that continue long after the projects have been handed over to the community. However, to ensure that long-term benefits do, in fact, accrue, the projects must be sustainable, which means appropriate technologies must be selected, and O&M should be integrated into project development from the beginning. Although, community-based projects may take longer to develop than short-term, agency-managed projects, the longer development time can be used to identify factors that would influence service sustainability. Often, critical aspects of O&M development have been neglected in short-term, agency-managed projects. Effective O&M brings about important health benefits by sustaining accessible water supplies in adequate quantity and quality; by reducing the time and effort spent on water collection; by allowing better sanitation facilities to be provided; and by providing income-generating activities.

This document focuses exclusively on community water supply and sanitation in developing countries (i.e. services that can be managed by communities in rural or low-income urban areas). It is designed to help planners and project staff select water-supply and sanitation technologies that can be maintained over the long term in rural and low-income urban areas. As has been repeatedly demonstrated worldwide, the selection of a particular technology can have far-reaching consequences for the sustainability of the services. For many years, technical criteria and initial investments were emphasized when choosing such technologies. Although these aspects are important, the roles of financial, institutional, social and environmental factors are also germane for ensuring the sustainability of services. In this manual, it is proposed that an O&M component be added to the selection process. With new actors, such as formal or informal private entrepreneurs, becoming increasingly involved, O&M is no longer simply a technical issue. It is now seen as encompassing social, gender, economic, cultural, institutional, political, managerial and environmental aspects, and is viewed as a key factor for sustainability.

1.2 Defining sustainability

“Sustainability” is now commonly used in the jargon of development staff. In this document, we have adopted a definition of sustainability that was developed throughout the 1990s. The definition is based on inputs from major conferences and events, and on field experience.

A service is *sustainable* when (IRC & WHO, 2000):

- It functions properly and is used.
- It provides the services for which it was planned, including: delivering the required quantity and quality of water; providing easy access to the service; providing service continuity and reliability; providing health and economic benefits; and in the case of sanitation, providing adequate sanitation access.
- It functions over a prolonged period of time, according to the designed life-cycle of the equipment.

- The management of the service involves the community (or the community itself manages the system); adopts a perspective that is sensitive to gender issues; establishes partnerships with local authorities; and involves the private sector as required.
- Its operation, maintenance, rehabilitation, replacement and administrative costs are covered at local level through user fees, or through alternative sustainable financial mechanisms.
- It can be operated and maintained at the local level with limited, but feasible, external support (e.g. technical assistance, training and monitoring).
- It has no harmful effects on the environment.

The importance of O&M for sustaining the level of services is illustrated in Figure 1.1 with a project designed to raise community benefits from level “A” (benefits are unsatisfactory, or non-existent), to level “B”. The project cycle includes three main phases: i) planning and design; ii) construction; and iii) O&M. If O&M is unsatisfactory in phase iii) of the project cycle the level of benefits will not be sustainable.

Figure 1.1 Sustainability in the project cycle

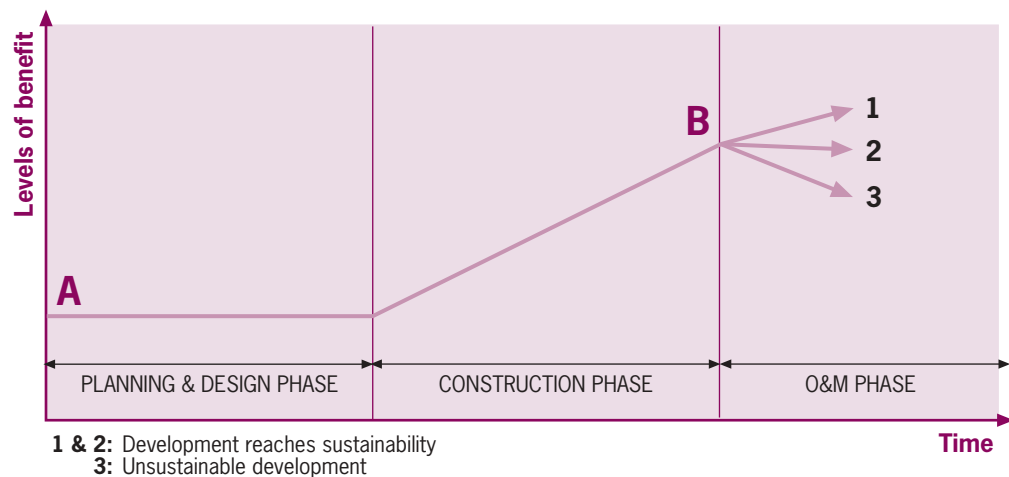

1.2.1 Factors that undermine the sustainability of improved services

The following factors commonly undermine the sustainability of services:

- The project is poorly conceived (e.g. a project that only increased the number of water points, or sanitation facilities, as a way of improving accessibility to these services, without considering the wider range of factors needed to sustain the benefits).
- The project did not sufficiently involve the community, who therefore did not feel that the project was theirs. As a result, demand for the improved services suffered, and the services became unsustainable. Demand and community involvement (of both men and women) are key factors in generating long-term community commitment to improved services and in sustaining the services. Involvement also makes the community members responsible for the choice of technology and makes community members aware of the financial, managerial and technical implications of their choice, including the future O&M tasks associated with the technology.
- The performance of the project facilities was either not assessed, or was insufficiently monitored, during the O&M phase of the project cycle.

1.2.2 Factors that contribute to the sustainability of improved services

Sustainability relies mainly on four interrelated factors: i) technical; ii) community; iii) environmental; and iv) the legal and institutional framework. A financial dimension underlies all of these factors.

Technical factors

- Technology selection.
- Complexity of the technology.
- The technical capacity of the system to respond to demand and provide the desired service level.
- The technical skills needed to operate and maintain the system.
- The availability, accessibility and cost of spare parts.
- The overall costs of O&M.

Community factors

- The demand or perceived need for an improved service.
- The feeling of ownership.
- Community participation (men/women, social groups) in all project phases, including planning, designing, constructing and managing the services, and in the O&M of the services. Community members should also be involved in generating demand for improved services.
- The capacity and willingness to pay.
- Management through a locally organized and recognized group.
- The financial and administrative capacity of management.
- The technical skills to operate and maintain the service, implement preventive maintenance activities, and perform minor and major repairs are all present in the community.
- Sociocultural aspects related to water.
- Individual, domestic and collective behaviour regarding the links between health, water, hygiene and sanitation.

Environmental factors

- The quality of the water source (this will determine whether the water needs to be treated, and will influence the technology choice).
- Adequate protection of the water source/point.
- The quantity of water and continuity of supply.
- The impact of wastewater or excreta disposal on the environment.

It is fundamentally important to integrate the water, hygiene and sanitation practices, because poor hygiene or inadequate access to sanitation facilities can jeopardize health benefits gained from improving access to water supplies.

Legal and institutional framework

All the above factors evolve within a legal and institutional framework. At national level, there must be clear policies and strategies that support sustainability. Support activities, such as technical assistance, training, monitoring, and setting-up effective financing mechanisms are all likely to influence the effectiveness of O&M.

In many developing countries, a decentralization process of the way in which institutions provide water-supply and sanitation services is being implemented. The main trends are towards letting the municipalities assume responsibility for the services, and towards involving the private sector (formal and informal) more actively in O&M. The changing

role of local institutions requires that their capacities be strengthened. Decentralization without building local capacities may lead to a sector performance even worse than that before decentralization.

Nongovernmental organizations (NGOs) are valuable counterparts in many planning and implementation activities. Public/private partnerships may also play an important role in O&M. Participation of the private sector may range from simple maintenance tasks, to the operation, maintenance and management of the entire system under well-regulated and controlled concession contracts.

Communication between central and local levels of government, and between the water and sanitation institutions and the development agencies, will help to coordinate activities and implement policies. A proper information and monitoring system relies on effective communication.

Capacity-building is needed at all levels, especially in a changing environment where new roles and responsibilities are introduced by new development processes.

1.3 Organization of the document – Fact Sheets

In Chapter 2, an overview is given of the selection process for community water-supply and sanitation technologies, with an emphasis on the role of O&M activities. The technologies themselves are then described in Chapters 3–8, using Fact Sheets with a standardized format (Figure 1.2). First, the technology is described, followed by the O&M activities associated with the technology. The actors involved and their roles are also discussed, as are the requirements and limitations of selected community water-supply and sanitation technologies currently in use in developing countries. The Fact Sheets can be copied or adapted to local circumstances, and discussed with communities during the technology selection process.

Figure 1.2 General format of Fact Sheets

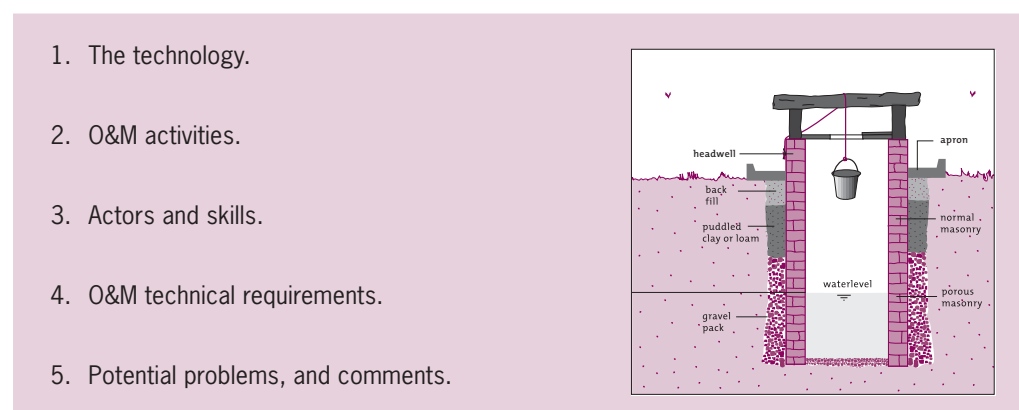

The Fact Sheets were developed, based on the literature available in the documentation centre of the IRC Water and Sanitation Centre, as well as on suggestions and comments from sector specialists, and on sources available on the web. Not all water-source options are included in the Fact Sheets. For example, ponds, water harvesting from surfaces other than roofs, diversion dams, and many kinds of intake structures. These options often depend on specific local circumstances, and it would not be practical to describe all such circumstances here. Bibliographical references are provided for more details.

2. The technology selection process

2.1 Introduction

The technology selection process will depend on the basic strategy adopted by planners, and on general trends in the water and sanitation sector. *Two basic principles outlined in this document are that communities need to be involved in selecting technologies from the start of the process, and that planners should adopt a demand-driven approach.*

The provision of water-supply and sanitation improvements can be characterized as either demand-driven or resource-driven. With a resource-driven approach, the intervention area is selected with minimal involvement of the community, and the technology is based on global policies, or replicates a blueprint or successful experience elsewhere. There are several potential problems with this approach that could undermine the sustainability of projects. Such problems include lack of community acceptance and poorly-functioning improvements that are underused. O&M costs can also be a concern if the technology was introduced without involving the interested parties (i.e. the communities) and without a proper analysis of local needs and conditions.

With a demand-driven project, by contrast, problems and needs are identified with the full participation of the communities. This may involve using extension workers to raise awareness in the communities prior to the start of the project. Communities can then choose a particular technology, with an understanding of the technical, financial and managerial implications of their choice. The advantages of such an approach are that the community is motivated to participate in the planning, construction and O&M phases, and that a community-based approach for managing the services will be better accepted and implemented. It is likely that a demand-driven approach will better foster a sense of ownership and responsibility.

Agencies, communities and users should therefore work together as partners, and agree upon planned activities. This has become particularly important, because users and communities are increasingly assuming the responsibilities of operating, maintaining and managing their water-supply and sanitation systems.

2.2 Factors that influence the selection of community water-supply technology

In this section, we review the general criteria, and criteria specific to O&M, that influence the selection of water-supply technologies. These criteria have been grouped into five factors that reflect the wider context of O&M in providing improved water supplies (see Table 2.1)

Experience has shown that the effectiveness of O&M is not solely connected to engineering issues, and personnel involved in O&M assessment and development should cover a range of relevant disciplines: social development, economics, health, institutional and management aspects, and engineering. It is important that the process be consultative and carried out in partnership with the operators and users of the services.

An economic alternative to investing in new water-supply projects is to rehabilitate defective services but, as with a new scheme, the rehabilitation option must include analyses of the community's preferences and needs, and of the capacity of the community to

TABLE 2.1 FACTORS THAT INFLUENCE THE SELECTION OF COMMUNITY WATER-SUPPLY TECHNOLOGY

Factors of general relevance	Factors specifically relevant to O&M
1. Technical factors	
<ul style="list-style-type: none"> — demand (present and future consumption patterns) versus supply; — capital costs; — extension capacity; — compatibility with norms and legal frameworks; — compatibility with existing water-supply systems; — comparative advantages; — technical skills needed within, or outside, the community. 	<ul style="list-style-type: none"> — dependence on fuel, power, chemicals; — quality and durability of materials; — availability of spare parts and raw materials; — O&M requirements; — compatibility with users' expectations and preferences (both men and women); — availability of trained personnel within the community; — availability of mechanics, plumbers, carpenters and masons within and outside the community; — potential for local manufacturing; — potential for standardization.
2. Environmental factors	
<ul style="list-style-type: none"> — availability, accessibility and reliability of water sources (springs, ground water, rainwater, surface water, streams, lakes and ponds); — seasonal variations; — water quality and treatment; — water source protection; — risk of a negative environmental impact. 	<ul style="list-style-type: none"> — O&M implications of water treatment; — O&M implications of water source protection; — existence and use of alternative traditional water sources; — O&M implications of wastewater drainage.
3. Institutional factors	
<ul style="list-style-type: none"> — legal framework; — regulatory framework; — national strategy; — existing institutional set-up; — support from government, NGOs, external support agencies (ESAs); — stimulation of private sector; — transferring know-how. 	<ul style="list-style-type: none"> — roles of different stakeholders and ability/willingness to take responsibilities for O&M; — availability of local artisans; — potential involvement of the private sector; — training and follow-up; — availability and capacity of training; — skills requirement; — monitoring.
4. Community and managerial factors	
<ul style="list-style-type: none"> — local economy; — living patterns and population growth; — living standards and gender balance; — household income and seasonal variations; — users' preferences; — historical experience in collaborating with different partners; — village organization and social cohesion. 	<ul style="list-style-type: none"> — managerial capacity and need for training; — capacity of the organization; — acceptance of the organizing committee by the community; — gender balance in committee; — perception of benefits from improved water supply; — the needs felt by the community; — availability of technical skills; — ownership.
5. Financial factors	
<ul style="list-style-type: none"> — capital costs; — budget allocations and subsidy policy; — financial participation of users; — local economy. 	<ul style="list-style-type: none"> — ability and willingness to pay; — level of recurrent costs; — tariff design and level of costs to be met by the community; — costs of spare parts and their accessibility; — payment and cost-recovery system to be put in place; — financial management capacity (bookkeeping, etc.) of the community.

sustain the system (potentially with the support of the water agency). When assessing the potential for rehabilitation, the community and the agency together need to study the reasons for the system's breakdown, analyse the problems involved, and formulate recommendations for feasible alternatives to rehabilitate the system. Rehabilitation should not be confined to replacing broken equipment or infrastructure. It is also important to look into the reasons why the system was not sustained and is in need of rehabilitation, including poor management, lack of maintenance (especially preventive maintenance), lack of skilled personnel, poor-quality materials and equipment, etc.

If a risk analysis is carried out for each water-supply option, then an attempt can be made to anticipate factors that may change and affect O&M. This will not be easy, especially in unstable economies where inflation and the availability of imported equipment and spare parts are difficult to predict. However, an indication of the risk attached to each option can be obtained by comparing the technologies.

2.3 The selection process for community water-supply technology

To help select the most appropriate technology, we propose that the selection process comprise five steps in which the factors associated with the technologies (Table 2.1) are considered. The steps are:

1. Request improved services.
3. Carry out a participatory assessment.
4. Analyse data.
5. Hold discussions with the community.
6. Come to a formal agreement on the chosen technology.

1. Request improved services

The community requests support from a governmental agency, NGO, or ESA to improve the community water supply. The request should preferably be in writing and come from a recognized community group or community leader. The request may be preceded by promotion and mobilization campaigns.

2. Carry out a participatory assessment

The support agency carries out a participatory baseline survey that includes a needs and problem analysis with the community. All the points listed below should be addressed:

- Initial service level assumption – what is the adequate level of service, taking into account both the users' preferences (both men and women) and the environment?
- What are the advantages of the technology options?
- What are the motivations, expectations and preferences of the users (both men and women)?
- What reliable water source is available?
- Can this source provide the required quantity and quality of water?
- What water treatment is needed?
- Can all social groups benefit from an improved water-supply system?
- What materials (and spare parts) and skills are needed to sustain the desired service level?
- What is the ability and willingness of the community (all social groups) to pay for the services?
- What is the management capacity of the community?
- What is the most appropriate structure to manage and sustain the desired service level?
- What are the costs (capital and recurrent) of the options considered?

- Are financial resources available?
- What is the present approach to O&M within the programme or area?
- What are the causes and effects of poor O&M within the area?
- What technical, financial and capacity-building assistance can the communities expect?
- What is the overall impact of the technology option selected?
- What is the availability and capacity of local expertise?

3. Analyse data

An analysis of the field data collected by the agency will identify a range of technology options and service levels. To choose the most appropriate technology, the options should be weighed with respect to the following:

Technical aspects

- Can the system supply an adequate quantity of water?
- What is the most appropriate water-treatment system?
- How much technical know-how is needed to operate and maintain the system?
- What materials and spare parts are needed, and how often?
- What technical design has been proposed?

Environmental factors

- What are the seasonal variations in rainfall and how do they impact the availability and quality of water?
- How is the water source to be protected?
- How is wastewater to be managed?

Management capacity

- What are the management options, including their contractual implications?
- Is the know-how available to manage each system? The abilities of both men and women should be considered in this analysis.

Financial sustainability

- What will the technology cost? The most appropriate technology is not necessarily the cheapest technology. A cheap technology can be costly in terms of maintenance, because it was constructed with low-quality materials, and it may be unable to meet demand. The cheapest solution acceptable to the community should be assessed both in terms of capital costs and O&M.
- What are the recurrent costs of a technology?
- What are the O&M and capital costs of the technology?
- What is the cost-recovery system? The system should include shared financial responsibilities; options for tariffs, and alternative financing in case the tariff does not cover all costs; and financial know-how.

4. Hold discussions with the community

Discussions should be held with the community on the technology options for the given environmental, technical and social context. Each option should be presented and discussed, and all O&M implications, such as committing to the long-term management of O&M, should be communicated. At the same time, any adjustments to be made to the existing O&M system should be clearly stated, and the responsibilities of the actors involved in developing the project should be defined.

5. Come to a formal agreement on the chosen technology

Once the community has made an informed choice of technology, a formal agreement should be sought between the community and all involved partners. When formulating an agreement, the following questions should be considered:

- Is the technology and service level affordable, manageable and maintainable at community level?
- Will all members benefit from the improved system?
- How can cost-recovery be organized?
- Who will take care of preventive maintenance, small repairs, big repairs?
- What type of support is still needed?
- What type of contribution is the community ready to give as an initial investment (in cash or kind)?

2.4 Factors that influence the selection of community sanitation technology

In the past, many sanitation projects were developed according to a conventional, technical approach, where the intervention and technology were determined by the implementing agency. Demand for sanitation was not assessed and there was little communication between the project planners and future users. Consequently, social, gender, cultural and religious aspects were not sufficiently considered when designing the project. In other cases, environmental factors were not considered in the design, which sometimes led to the collapse of pit walls and unsafe situations. In low-income urban areas, for example, where pit emptying is often a necessity, such services were often absent or could not be sustained, but this was not considered in the project design. Also, hygiene education to improve the sanitation behaviour of the community was rarely included in sanitation projects, because education and sanitation projects had different implementation time-scales.

As described above, the factors that influence the choice of sanitation technology can be categorized into technical, environmental, institutional and community factors (Table 2.2). To aid the technology selection process, the factors can be further classified as to whether they are of general relevance to the selection process, or specifically relevant to the O&M component. Sanitation interventions need to be planned with a comprehensive approach, so that all these factors are properly addressed.

It is not always necessary to build a new sanitation facility: it may be possible to upgrade the existing system. The rationale for upgrading as the first option for improving sanitation is that the existing sanitation facilities reflect the social and cultural preferences of the community, as well as the local economic and technical capacities. If existing community facilities do not meet the basic requirements of hygiene, then upgrading such facilities should be considered first. If there are no sanitation facilities, then the most appropriate technology option should be considered, using the following selection process.

2.5 The selection process for community sanitation technology

The process of choosing a sanitation technology should include at least the following steps:

1. Request improved services

Again, the first step is for a community to request improved services. Once a demand for improved sanitation facilities has been expressed, technology selection should be preceded by, or based upon, a participatory need assessment. Hygiene awareness and promotion campaigns can increase demand for improved sanitation facilities.

TABLE 2.2 FACTORS THAT INFLUENCE THE SELECTION OF COMMUNITY SANITATION TECHNOLOGY

Factors of general relevance	Factors specifically relevant to O&M
1. Technical factors	
<ul style="list-style-type: none"> — design preference (substructure, floor slab, squatting or raised seat, superstructure); — technical standards and expected lifetime of the technology; — availability of construction materials; — cost of construction. 	<ul style="list-style-type: none"> — O&M requirements; — ease of access; — use of decomposed waste; — pit-emptying technique.
2. Environmental factors	
<ul style="list-style-type: none"> — soil texture, stability, permeability; — groundwater level; — control of environmental pollution; — availability of water; — possibility of flooding. 	<ul style="list-style-type: none"> — O&M implications for environmental protection; — protection against groundwater contamination; — protection from flooding.
3. Institutional factors	
<ul style="list-style-type: none"> — existing national/local strategies; — roles and responsibilities of actors implied; — training capacity; — availability of subsidies and loans; — availability of masons, carpenters, plumbers, sanitary workers, pit-emptiers and pit-diggers. 	<ul style="list-style-type: none"> — pit-emptying services (municipal/private); — sewerage maintenance capacity; — potential involvement of the private sector; — national budget allocations for sanitation; — training and awareness education; — monitoring.
4. Community factors	
<ul style="list-style-type: none"> — sociocultural aspects: taboos, traditional habits, religious rules and regulations, cleansing material, preferred posture, attitude to human faeces, gender-specific requirements; — motivational aspects: convenience, comfort, accessibility, privacy, status and prestige, health, environmental cleanliness, ownership; — discouraging factors: darkness, fear of falling in the hole, or of the pit collapsing, or of being seen from outside, smells; insect nuisance; — social organization factors: role of traditional leadership, religious leaders, schoolteachers, community-based health workers; — other factors: population densities, limited space for latrines, presence of communal latrines. 	<ul style="list-style-type: none"> — O&M costs; — O&M training and awareness for sanitation; — health awareness and perception of benefits; — presence of environmental sanitation committee; — women's groups; — social mobilization on hygiene and sanitation behaviour.

2. Carry out a participatory assessment

A participatory assessment should be carried out to determine if there are problems related to: the existing human excreta-disposal system; hygiene and defecation behaviour (among men, women and children); the hygienic environment; and human excreta-related diseases. Also necessary are: a participatory assessment of the cultural, social and religious factors that influence the choice of sanitation technology; a participatory assessment of local conditions, capacities and resources (material, human and financial); and the identification of local preferences for sanitation facilities, and possible variations.

3. Analyse data

Data should be collected on all the factors listed in Table 2.2. Several criteria can help in the analysis of the data and in choosing the design of the sanitation system:

- Match user preferences according to local capacities and environmental conditions, such as whether there is the risk of contaminating water sources. The preferences of all users should be considered, including men, women and children.
- Match investment requirements to the costs of the technology and to the community's ability/willingness to pay.
- Match community needs to the availability of materials.
- Match the proposed design options to the availability of craftsmanship.
- Match O&M requirements to the prevailing sanitation behaviour and to local capacities.
- Identify promotional campaigns, micro-credit mechanisms and hygiene education programmes that could accompany the technology selection and installation process.

4. Hold discussions with the community

Discussions should be held with the community about sanitation options, and include discussions about the technical, environmental, financial and hygiene implications of each option.

5. Select the technology

The community should select the technology, with support from the agency. This will contribute to the sustainability of the technology and increase the number of community members who will use it.

The improvement of sanitation facilities should be accompanied by Information, Education, Communication (IEC) activities to promote safe sanitation behaviour and proper hygiene. These activities have a longer time horizon than the physical improvement of structures. Schools, institutions, and religious and social community groups should play a prominent role in promoting proper hygiene and sanitation behaviour. Special attention must also be paid to the technology design and its siting, to prevent the sanitation facilities from polluting the environment, particularly water resources and the immediate living environment. Control measures must be carried out to minimize these risks.

2.6 Assessing O&M needs

2.6.1 O&M activities

This section provides information on the O&M activities required for each technology. Within a specific technology, for example handpumps, the tools and activities needed for different brands of handpumps can be quite different. In such cases, the manufacturer of the brand is identified. The activities described in the Fact Sheets give the main elements involved in day-to-day O&M for each technology. An important aspect of O&M is preventive maintenance, and if it is well-organized and implemented it can reduce the frequency of repairs, prolong the lifetime of a technology, and lower recurrent costs.

The description of each technology includes: the O&M activities required, and their frequency; the human resource needs; and the materials, spare parts, tools and equipment needed. This information shows the importance of O&M in terms of human and technical requirements. For example, activities and repairs are part of O&M and the frequency with which they need to be carried out depends largely on elements such as the quality of materials, the quality of workmanship during the construction phase, and the level of corrective and preventive maintenance carried out by the actors concerned.

2.6.2 Spare parts

The lack of spare parts may be a major constraint in the sustainability of water supplies and can even lead to the water supplies being abandoned. A lack of spare parts can result from policies pursued by the donors, such as when hardware has to be purchased from the donor countries. Many donors, however, are only involved in the construction phase of the project and make no provision for continuing the supply of spare parts after handing over the project to the community. Some donors have attempted to overcome the problem by supplying a stock of spares at the time of installation. But this is only a short-term remedy, because the absence of a supply system and the lack of foreign exchange means that stocks do not get replenished.

Even when donors have bought and installed equipment already used within a country, there has often been no consistent government or water-agency policy on standardization. The outcome is a wide range of equipment, for which no water agency in a developing country can afford to stock a comprehensive range of spare parts. Spare parts availability and supply are therefore major considerations if water supplies are to be sustainable and suitable for community management.

The availability of spare parts should be one of the main factors that determines the suitability of a particular technology. Before opting for a technology, the mechanism for supplying spare parts must be investigated, established and assured. Often, however, the issue of spare parts arises only after the technology has been selected and installed, which puts its sustainability at risk.

The community will need to know the cost of running their water-supply and sanitation systems, and this will be determined partly by the demand for spare parts. Estimates may be based on previous experience, or on guidance from the manufacturers. Care must be exercised when using manufacturers' figures for spare parts, since the need for spares will vary according to local circumstances. For example, the air filter for a diesel generator will require more frequent changes in a very dusty environment, compared to "standard" conditions. The extent of use, the care with which the equipment is used, and the effectiveness of preventive maintenance will all have an impact on the need for spare parts.

Spare parts can be divided into three categories:

- *frequently needed* spare parts, for which the accessibility should be as close as possible to the village (shop, mechanic);
- *occasionally needed* spare parts (every six months or every year), for which accessibility can be at a nearby major centre;
- *major rehabilitation or replacement* spare parts, for which accessibility can be at the local or regional level, or at the state capital.

Several countries have chosen to standardize the choice of technology; this choice has positive as well as negative aspects, which should be carefully considered before applying such a policy.

A principal guideline of the VLOM concept is that the supply of spare parts can be improved if the parts are manufactured within the country of use. The equipment should be designed so that the parts that wear out are simple to manufacture from readily-available materials. Manufacturers can be encouraged to produce the equipment locally by mobilizing local entrepreneurs and by ensuring the right environment. Local businesses will need the appropriate licences to import raw materials, and tax policies should encourage, rather than inhibit, local industry. Manufacturers in other sectors (e.g. plastics and steel) can also be encouraged to manufacture their products locally. The local manufacture of spare parts depends on a supply of raw materials, consumables (e.g. welding rods) and machinery, and these factors should be taken into account when choosing a

TABLE 2.3 PROS AND CONS OF STANDARDIZING TECHNOLOGY

FOR standardization	AGAINST standardization
<ul style="list-style-type: none"> — common use of the same item of equipment encourages agencies and shopkeepers to store and supply spare parts, because there is a “guaranteed demand”; — standardization avoids the proliferation of brands and technologies, which would make it easier to stock and supply spare parts; — the prices and market for spare parts can be more easily determined; — users become familiar with one type of technology; — personnel training can be standardized. 	<ul style="list-style-type: none"> — the chosen technology does not fully respond to the needs and preferences of users; — the market is closed to new, innovative and cheaper technologies; — there is little incentive for the private and research sectors to become involved; — standardization limits price competition between different brands and impedes optimization; — limiting technology choice may conflict with donor policies.

technology. The possibility of substituting materials can be investigated (e.g. using hardwood bearings instead of plastic bearings).

Output should satisfy demand, but as demand may be irregular, a stock of parts can act as a buffer. However, this requires that capital be available at the beginning of production for materials, labour, overhead costs and storage. A government subsidy or donor grant can provide the initial kick-start. To ensure the compatibility and reliability of parts, it may be necessary for the government to institute standards and an inspection procedure.

2.6.3 Roles and responsibilities¹

Who is supposed to operate and finance the system? In theory, various actors could share the financial burden of a water-supply and sanitation agency: users, government, NGOs, donors, and so on. We propose that the financial responsibilities for a system should be linked with the management and/or operational responsibilities. This will mean that for each task required to manage, maintain and replace the water-supply system, there is someone responsible for implementing the task, and someone responsible for financing it. It may take time to transfer responsibilities during the transition period to a linked system, and this should be taken into account in the planning process.

Example 1: handpump

This example illustrates a situation in which the community owns and manages the handpump. For technical know-how and services, however, the community still depends on specialized mechanics who have to be paid by the community. The transfer of responsibility to the community does not eliminate the responsibilities of the government in areas such as water-quality surveillance, the development of an effective spare-parts distribution system, and in rehabilitation and replacement. Unfortunately, water-quality control is rarely (if at all) carried out in rural areas, and it might be necessary to monitor water quality using simple equipment that communities can afford.

¹ Extracts from: Brikké & Rojas (2001).

TABLE 2.4 DISTRIBUTION OF RESPONSIBILITIES FOR THE O&M OF A HANDPUMP^a

O&M tasks	Operational responsibility	Financial responsibility
<ul style="list-style-type: none"> — monitor handpump use and encourage proper use; — check all nuts and bolts, and tighten if necessary; — measure output per stroke and compare with expected output; — check and adjust pump handle and stuffing box; — grease or oil all hinge pins, bearings, or sliding parts; — clean the pump, well head, concrete apron, and drainage area; — check well head, concrete apron, drainage area, and repair cracks; — record all O&M activities in a notebook. 	♀	♀
<ul style="list-style-type: none"> — disassemble the pump and check the drop pipe, cylinder, leathers, and foot valve for corrosion and wear; — repair or replace parts, as necessary. 	♀ and ⚙	♀
<ul style="list-style-type: none"> — conduct water tests for microbial contamination; — check the water level and test the well yield. 	🏛 and ♀	🏛 and ♀
<ul style="list-style-type: none"> — in case of contamination, locate and correct the source of contamination, and disinfect; — adjust the cylinder setting if necessary; — replace the entire handpump when worn out. 	⚙ or 🏛	♀ and 🏛
<ul style="list-style-type: none"> — manage a stock of spare parts, tools and supplies. 	♀ and ⚙ and 🏛	

^a Source: Roark, Hodgkin & Wyatt (1993).

♀ = Community. ⚙ = Local mechanic/private sector. 🏛 = Government.

Example 2: pump, diesel engine and standpost

This system is managed by the community and the responsibilities are distributed throughout the community. The government remains responsible for rehabilitation, replacement, and water-quality control. The distribution of responsibilities should not stay the same forever. To the contrary, if communities are to be fully empowered to carry out their responsibilities, the financial responsibilities of community and government are likely to change.

TABLE 2.5 DISTRIBUTION OF RESPONSIBILITIES FOR THE O&M OF A PUMP, DIESEL ENGINE AND STANDPOST^a

O&M tasks	Operational responsibility	Financial responsibility
<ul style="list-style-type: none"> — operate the engine daily in a safe and efficient manner; — perform regular checks and adjustments (fuel, oil, filters, belts, etc.); — regularly replace engine oil, filters and pump oil, as necessary; — check all pipelines, tanks and valves for leaks and breaks, and repair them; — monitor standpost use and encourage proper use; — check all standposts for leaks, wear and tear, and repair them if needed; — flush all pipes periodically; — clean the standpost concrete apron and drainage area, and make necessary repairs; — record all O&M activities in a log book; — manage a stock of fuel and oil, and ensure that it is properly stored and secured; — maintain a special fuel log; — develop schedules for preventive maintenance and monitoring. 	♀	♀

TABLE 2.5 CONTINUED

O&M tasks	Operational responsibility	Financial responsibility
— perform regular checks and adjustments on alternator, starter, radiator, valves and injectors.	👤 and 🔧	👤
— conduct water tests for microbial contamination, and locate and correct any sources of contamination; — disinfect the system; — establish historical records of all engines, pumps and other equipment.	🏛️ and 👤	🏛️ and 👤
— measure water output periodically, both at the well head and at the standpost; — assess leakage and make necessary repairs; — periodically conduct complete overhauls on engine, pumps and associated equipment; — rehabilitate the engine/pump for the well, and/or replace it.	👤 and 🔧	👤 and 🏛️
— manage a stock of parts, tools and supplies.	👤 and 🔧 and 🏛️	

^a Source: adapted from Roark et al. (1993).

👤 = Community. 🔧 = Local mechanic/private sector. 🏛️ = Government.

Example 3: administrative and support activities

This example shows how administrative tasks and support activities can be distributed between the community and the government agency. The community can assume operational and financial responsibilities for most of the tasks that are directly related to the community, or fall within the community's boundaries. However, government agencies or NGOs have operational responsibility for all support activities. In recent projects, communities have also been asked to pay for support services once the project was handed over. However, the debate is not yet closed on this issue.

TABLE 2.6 DISTRIBUTION OF RESPONSIBILITIES FOR ADMINISTRATIVE AND SUPPORT ACTIVITIES LINKED TO O&M^a

Administrative and support tasks linked to O&M	Operational responsibility	Financial responsibility
— conduct technical and socioeconomic participatory studies.	👤 and 🏛️*	🏛️*
— prepare annual budgets and long-term financial estimates; — analyse O&M tasks for use in planning and budgeting; — collect, analyse and monitor results, and conduct follow-up support or training, as required.	👤 and 🏛️*	👤 and 🏛️*
— develop and evaluate technical and management training for water and sanitation system operators; — develop and evaluate financial and management training for community managers; — provide technical training for operators; — provide financial and management training for community managers; — develop simple information materials on hygiene education; — provide technical and management support to community managers.	🏛️*	🏛️*

TABLE 2.6 CONTINUED

Administrative and support tasks linked to O&M	Operational responsibility	Financial responsibility
— select and appoint operators/contractors for O&M;		
— delegate task responsibilities;		
— supervise and pay salaries;		
— keep archives, inventories and log books;		
— collect water fees and manage revenues;	†	†
— make payments for purchases, loans and other obligations;		
— respond to users' complaints;		
— organize and conduct general meetings for discussions;		
— hold elections;		
— organize community contributions for upgrading or extending the system;		
— report urgent problems to the government agency.		

^a Source: adapted from Roark et al. (1993).

† = Community. ✖ = Local mechanic/private sector. 🏛️* = Government and/or NGOs.

In the next step, the distribution of operational and financial responsibilities should be formalized in an agreement or contract that describes the rights and obligations of each party, and defines the mechanisms for non-respect of the agreement.

In many countries, the water committee does not have proper legal status and is vulnerable to material, financial, contractual and legal problems. For this reason, any agreements or contracts should include the status of the water committee. General legal status is based on the following:

- The Municipality officially registers a Committee that has been elected by a General Assembly of users; a “constituting” Act must be produced by the Assembly.
- The Water Committee is registered at the Chamber of Commerce either as a non-profit-making association, or as an association with an economic interest, which then allows it to operate as a concession or under contractual arrangements with local authorities.
- The Water Committee operates under the legal mandate of a Development Association.

2.6.4 Partnership and management

Management models range from highly centralized government systems to localized community management. Typically, O&M management systems comprise stratified levels of maintenance and repair bodies. A common model has the central government agency on the first tier, the regional government or private body on the second tier, and the community organization on the third tier. Traditional water supplies are managed by a single-tier system of community management.

Past experience has shown that centralized, government-controlled systems of management have not always been able to sustain supplies. In contrast, the “partnership approach” is a more equal and supportive relationship between the community and external organizations, which fosters joint decision-making and management from the start of the project. This is essential if the choice of technology and the design of the scheme are to meet the community’s needs and expectations, without exceeding the capacity of the community to operate and maintain the system in the long term. The partnership starts at the beginning of the project and continues through every stage of the project cycle, from feasibility through construction, to the management of O&M. Partnership should be seen as a flexible and evolutionary process, requiring continual dialogue. The sharing of costs and responsibilities will vary according to the type and stage of development of

the partnership. Some communities will want, and be able, to manage a major share of responsibilities from the outset. Others will need to start with a low level of responsibility and gradually build their expertise and confidence.

All communities are composed of people who vary by ethnicity, gender, socioeconomic status, religion, politics and age. One of the challenges of O&M management is to make sure that all groups are properly organized and work together, so as to ensure effective water-supply and sanitation services to the whole community. The degree of community cohesion can be a critical factor in determining the type of water supply and how it should be implemented and managed. For example, a divided community may not work happily together on the management of a common piped distribution system, whereas separate handpumps for each group might be acceptable. Conversely, the management of a water supply might provide the opportunity for previously divided communities to work together.

Communities can be compact villages or scattered settlements. The distribution of people in a community can have an important influence on the choice of water-supply technology, and on the O&M management system. For example, in a village that has developed along the line of a road, a handpump is likely to serve a limited number of people. Therefore, only a small section of the village may be interested in its management and in paying O&M contributions. This is likely to be the same for a borehole drilled on the edge of a large village, or within a widely scattered settlement. If the small user group is unable to fund handpump O&M, then a technology requiring lower maintenance costs might be more appropriate (e.g. a protected dug well).

Piped supplies are often attractive to users because they reduce the time and effort users spend obtaining water. However, potential users may be reluctant to participate or contribute to a scheme if there appears to be no extra benefit. For example, people served with a non-protected well that provides sufficient quantities of water to the household might not be willing to participate in funding the construction of a piped system. Their participation will require a good marketing campaign to highlight the advantages of a piped system.

The management of a large scheme that supplies several sections of a village or several communities is clearly more complex than the management of a single well. As far as capital costs are concerned, it may be more cost-effective to supply a large number of people with an extensive distribution network, than to have several smaller, piped networks supplying individual groups or communities. However, extensive distribution schemes are only appropriate if all the communities can work together effectively. Furthermore, the O&M of large schemes will not necessarily be as cost-effective as small, community-managed schemes. Communities can benefit by working with others in loose cooperations or in formal associations. Success in one project can lead to success in others and the multiplier effect in a region can be significant.

Some projects have attempted to by-pass traditional leadership structures that have appeared unrepresentative to the agency staff. Sometimes, this has created problems, since the degree of user representation through such traditional decision-making bodies will determine the extent to which all members of a community can be involved. Outsiders must be careful not to miss the informal consultation mechanisms that lie behind many formal bodies, such as the informal representation of women's views through women's networks and leaders.

2.6.5 Recurrent costs

It is difficult to find comparable and accurate data on recurrent costs. Indeed, calculations of recurrent costs vary widely from one project or country to another and include different items. Moreover there are large differences in wage, equipment and material

costs. Nevertheless, even though data may only be valid for the context in which a particular project has been developed, they can give an idea about the importance of these costs. However, it is advised to use such figures with caution, and to actually measure recurrent costs for specific projects in the following way:

This basic recurrent cost estimation does not include elements, such as depreciation, replacement costs, initial capital reimbursement, training costs, environmental protection costs, etc. Depending on the strategy and policy of projects, these additional costs might have to be included in the final total of recurrent costs.

Another difficulty is that recurrent costs are presented in different ways in the literature: cost per m³, cost per capita, cost per year, cost per household. The most relevant way to present recurrent costs for community-managed water-supply systems would be the cost per household, since households are the basic economic unit and costs could be compared to the affordability of households. However, cost/m³ can allow a better comparison between projects and countries, since the size of households and their consumption can vary greatly from one country to another.

The recent trend is to ask the users to pay for many of the direct and local-level costs of O&M. Additional funds are also required to provide agency support (e.g. payment of extension staff, training and monitoring). Even though a community may contribute to the direct O&M costs, funds may still be required to cover agency costs incurred from supporting O&M activities. It is common practice for support costs to be subsidized by the government and external agencies. However, if sustainability is to be achieved, full coverage of O&M costs is the goal to be pursued. Communities are expected to contribute both the direct and support costs of O&M, especially if replacement costs have to be included.

O&M costs can only be recovered from users if they are both able and willing to pay for the water-supply and sanitation services. It is commonly accepted that people should not have to pay more than 3%–5% of their income for water and sanitation services, though actual payments vary greatly. A higher percentage of income expended on water will mean that other important needs may not be fully met. Great care is therefore required when setting users' tariffs and contributions.

Even if users can afford to meet the O&M costs they may still be unwilling to pay. Before committing themselves to paying for a technology, people will want to weigh the cost of an improved supply against a range of factors (Box 2.2).

BOX 2.1

Estimating basic recurrent costs

- list all necessary O&M activities, as well as the frequency with which they will be needed;
- for each activity, list all the human resources, materials, spare parts, energy, tools and equipment required;
- estimate how much of each item is needed;
- define the activity cost for each item;
- add up the costs of all activities.

BOX 2.2

Factors that influence the willingness of users to pay

- income;
- service level;
- quality of service;
- perceived benefits;
- opportunity costs;
- acceptability of the existing source;
- community cohesion;
- policy environment;
- perception of ownership and responsibility;
- institutional framework.

3. Water sources and intakes

3.1 Introduction

In Chapters 3–7, the technologies used in water-supply systems are considered in sequence, from the water source to the points of supply: water sources and intakes (Chapter 3); water-lifting devices (Chapter 4); power technologies (Chapter 5); water treatment (Chapter 6); storage and distribution (Chapter 7). The technologies for each these subsystems must function properly to ensure a reliable water supply, and for the water-supply system to be sustainable the O&M requirements of each technology must be fully met. The O&M implications of the most common technologies for each subsystem are described, but the intention is not to compare manufacturers or their equipment. It is to provide information about the O&M implications of the different technologies that is independent of the technology origin.

When choosing a technology, the rationale for using a particular water source should be considered. Several types of water sources, such as wells, ponds, rivers or springs are traditionally used for different purposes and they may not be operational all year. Some water sources are more reliable, convenient, or provide water that tastes better. If users perceive an “improvement” as something “worse” in any one aspect, they may return to their traditional, contaminated source. Chlorinating water, for instance, may introduce odour or taste and it may be necessary to explain the need for chlorination to users.

The following list of community water sources and intake technologies is not exhaustive, but represents those most commonly found in developing countries:

Rainwater

- rooftop rainwater harvesting (section 3.2);
- catchment and storage dams (section 3.3).

Groundwater

- springwater collection (section 3.4);
- dug well (section 3.5);
- drilled wells (section 3.6);
- subsurface harvesting systems (section 3.7).

Surface water

- protected side intake (section 3.8);
- river-bottom intake (section 3.9);
- floating intake (section 3.10);
- sump intake (section 3.11).

Each of these technologies is reviewed in the Fact Sheets in the following pages, with an emphasis on the O&M implications.

3.2 Rooftop rainwater harvesting¹

3.2.1 The technology

Rooftop catchment systems gather rainwater from the roofs of houses, schools, etc., using gutters and downpipes (made of local wood, bamboo, galvanized iron or PVC), and lead it to storage containers that range from simple pots to large ferrocement tanks. If properly designed, a foul-flush device or detachable downpipe can be fitted that allows the first 20 litres of runoff from a storm to be diverted from the storage tanks. The runoff is generally contaminated with dust, leaves, insects and bird droppings. Sometimes the runoff is led through a small filter of gravel, sand and charcoal before entering the storage tank. Water may be abstracted from the storage tank by a tap, handpump, or bucket-and-rope system

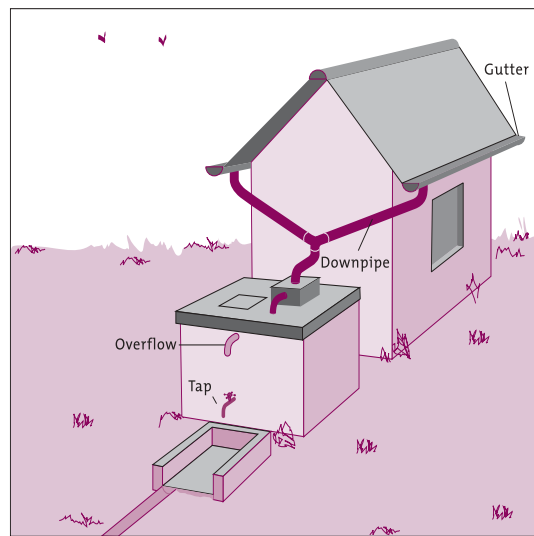

Figure 3.2 Rooftop catchment

Initial cost: In Southern Africa, US\$ 320 for a system with 11 m of galvanized iron gutter; a 1.3 m³ galvanized iron tank; downpiping; tap and filters; cost does not include transportation (Erskine, 1991). Where roofs are not suitable for water harvesting, the cost of roof improvement and gutters will have to be added to the cost of a tank. Such costs varied from US\$ 4 per m² (Kenya, subsidized) to US\$ 12 per m² (Togo) (Lee & Visscher, 1992).

Yield: Almost 1 litre per horizontal square meter per millimetre of rainfall. The quantities are usually sufficient only for drinking purposes.

Area of use: In most developing countries with one or two rainy seasons (especially in arid and semi-arid zones, with an average annual rainfall ranging from 250 mm to 750 mm) and where other improved water-supply systems are difficult to implement.

3.2.2 Main O&M activities

Operations consist of taking water from the storage tank by tapping, pumping or using a bucket and rope. Where there is no foul-flush device, the user or caretaker has to divert away the first 20 litres at the start of every rainstorm, and keep the rooftop clean. Just before the start of the rainy season, the complete system has to be checked for holes and for broken or affected parts, and repaired as necessary. Taps or handpumps (if used) have to be serviced. During the rainy season, the system should be checked regularly and cleaned when dirty. The system should be also checked and cleaned after every dry period of more than one month. The outsides of metal tanks may need to be painted about once a year. Leaks have to be repaired throughout the year, especially from leaking tanks and taps, as they present health risks. Chlorination of the water may be necessary.

All O&M activities can normally be carried out by users of the system. Major repairs, such as a broken roof or tank, can usually be carried out by a local craftsman using locally-available tools and materials. Maintenance is simple, but should be given careful attention.

¹ Pacey & Cullis (1986); Lee & Visscher (1990, 1992).

It is more difficult to organize the O&M of shared roof or ground-tank supplies than it is for privately-owned systems. Rooftop-harvesting systems at schools, for instance, may lose water from taps left dripping. Padlocks are often needed to ensure careful control over the water supply. Ideally, one person should be responsible for overseeing the regular cleaning and occasional repair of the system, control of water use, etc. One option is to sell the water, which ensures income for O&M and for organizing water use. Where households have installed a communal system (e.g. where several roofs are connected to one tank), the users may want to establish a water committee to manage O&M activities. The activities may include collecting fees, and controlling the caretaker's work and the water used by each family. External agents can play a role in the following O&M areas:

- monitoring the condition of the system and the water quality;
- providing access to credit facilities for buying or replacing a system;
- training users/caretakers for management and O&M;
- training local craftsmen to carry out larger repairs.

3.2.3 Actors and their roles

Actors	Roles	Skills required
Users.	Close taps after taking water, keep system clean.	☺
Caretaker.	Check functioning, divert first flush, clean filters and rest of system, perform small repairs.	✂
Local craftsman.	Repair roof, piping and tank.	✂✂
External support.	Check water quality, motivate and guide local organization, train users.	✂✂✂

In case of community-owned system

Water committee.	Supervise the caretaker, collect fees, and pay bills.	✂
------------------	---	---

☺ Simple (often requires gender-specific awareness-raising, and training activities to change behaviour and build capacity);
 ✂ Basic skills. ✂✂ Technical skills. ✂✂✂ Highly qualified.

3.2.4 O&M technical requirements

Activity and frequency	Materials and spare parts	Tools required
1–3 times per year		
— clean the system.	Disinfectant.	Broom, brush, bucket.
Every six months		
— clean and disinfect the reservoir.	Disinfectant.	Bucket.
Every storm		
— divert the foul flush.		
Occasionally (as the need arises)		
— repair the roof, gutters and piping;	Depending on the type of roof: tiles, metal sheet, asbestos cement sheet, etc.; bamboo or PVC pipes; nails; wire.	Hammer, saw, pliers, tin-cutter.
— repair the tap or pump;	Washers, cupseals, etc.	Spanner, screwdriver.
— repair the ferrocement reservoir;	Cement, sand, gravel, metal mesh.	Wire trowel, bucket, pliers.
— paint the outsides of metal reservoirs.	Anticorrosive paint.	Steel brush, paintbrush.

3.2.5 Potential problems

- corrosion of metal roofs, gutters, etc.;
- the foul-flush diverter fails because maintenance was neglected;
- taps leak at the reservoir and there are problems with the handpumps;
- contamination of uncovered tanks, especially where water is abstracted with a rope and bucket;
- unprotected tanks may provide a breeding place for mosquitoes, which may increase the danger of vector-borne diseases;
- during certain periods of the year, the system may not fulfil drinking-water needs, making it necessary to develop other sources, or to go back to traditional sources during these periods;
- often, households or communities cannot afford the financial investment needed to construct a suitable tank and adequate roofing.

3.3 Catchment and storage dams¹

3.3.1 The technology

Water can be made available by damming a natural rainwater catchment area, such as a valley, and storing the water in the reservoir formed by the dam, or diverting it to another reservoir. Important parameters in the planning of dams are: the annual rainfall and evaporation pattern; the present use and runoff coefficient of the catchment area; water demand; and the geology and geography of the catchment area and building site. Dams can consist of raised banks of compacted earth (usually with an impermeable clay core, stone aprons and a spillway to discharge excess runoff), or masonry or concrete (reinforced or not). In this manual, we refer only to dams less than a few metres high. The water stored behind a dam should normally be treated before entering a distribution system.

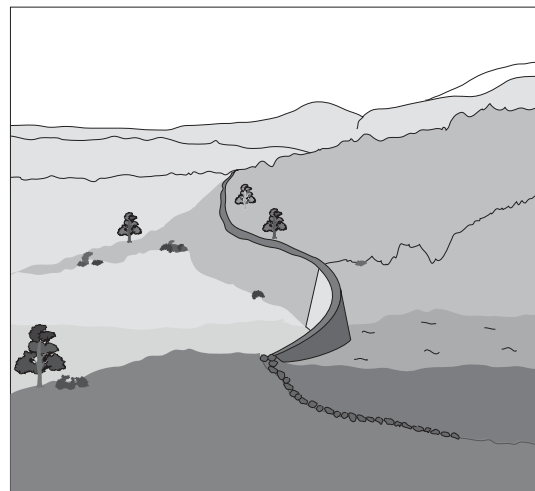

Figure 3.3 A small dam

Initial cost: This depends on local circumstances. The cost of a 13 000 m³ rock catchment in Kenya was US\$ 1.60 per m³ of storage volume. The corresponding cost of a 30 000 m³ earth dam in Tanzania was US\$ 1.90, and only US\$ 0.20 for an 80 000 m³ earth dam in Mali.

Dimensions: Usually, no more than a few metres high, or as low as one metre. The width can be from a few metres to hundreds of metres.

Area of use: Mostly in hilly or mountainous regions where other water sources are scarce.

Design: If the dams are to be higher than a few metres it is recommended that community members ask specialized engineers to design the dams.

¹ Lee & Visscher (1990, 1992).

3.3.2 Main O&M activities

Caretaker operations can include activities such as opening or closing valves or sluices in the dam, or in conduits to the reservoir. The actual water collection from water points is usually carried out by the users themselves, often women and children.

If the water is for human consumption, cattle and people should be kept away from the catchment area and reservoir all year round. This can be helped by having a watchman patrol regularly, and by fencing off the area. Water should be provided to users through a treatment plant and a distribution system with public standpipes or household connections. The dam, valves, sluices and pipelines have to be checked for leaks and structural failures. If repairs cannot be carried out immediately, the points of failure should be marked. The catchment area must also be checked for contamination and erosion. To control erosion, grass or trees could be planted just before the rainy season, and a nursery may have to be started.

Once a year, the reservoir may be left to dry out for a short period to reduce the danger of bilharzia. The reservoir, silt traps, gutters, etc., must be de-silted at least once a year. To control mosquito breeding and the spread of malaria, *Tilapia* fish can be introduced in the reservoir (every year if it runs dry).

For a properly functioning and sustainable surface harvesting system, the users will need to establish an organization that can deal with issues, such as:

- the water consumption allowed for each user;
- preventing unauthorized use by passers-by;
- preventing water contamination;
- inequitable abstraction;
- solving upstream-downstream conflicts (e.g. where the system has altered the natural hydrology);
- O&M activities and their financing;
- agreements on contributions by each household towards the O&M of the system (e.g. should they be in cash, kind or labour).

A person who lives or farms near the site could be appointed for O&M tasks at the reservoir and the catchment area. If users get their water at or near the reservoir, this person could also be made responsible for water allocation, and be involved in monitoring activities. The authority of this person should clearly be accepted by the users of the system.

3.3.3 Actors and their roles

Actors	Roles	Skills
Users.	Keep the catchment area clean, carry out preventive maintenance.	☺
Caretaker.	Perform small repairs.	✘
Water committee.	Organize repairs and cleaning, collect fees.	✘
Local technician.	Repair concrete, masonry and piping.	✘✘
External support.	Provide support for checking the water quality of the system, motivate and guide local organization.	✘✘

☺ Simple (often requires gender-specific awareness-raising, and training activities to change behaviour and build capacity);
✘ Basic skills. ✘✘ Technical skills.

3.3.4 O&M technical requirements

Activity and frequency	Materials and spare parts	Tools and equipment
Daily		
— check for leaks, damage, erosion, etc.		
Occasionally		
— repair leaks in the dam;	Clay, cement, sand, gravel.	Hoes, spades, buckets, trowels, etc.
— repair or replace valves.	Washer, spare valve.	
Annually		
— de-silt the dam, conduits, silt traps, etc.		Hoes, spades, buckets, wheelbarrows, etc.

3.3.5 Potential problems

- contamination of the water by chemical spraying, overgrazing, industry and the agro-industry, land clearing, settlements, animal excrement, etc;
- waterborne and water-related diseases, such as bilharzia and malaria;
- the reservoir silts up;
- earth dams can be damaged by cars, animals or people walking over them;
- dams and reservoirs become undermined by seepage, rodents or other causes;
- the dam fails or collapses, causing injury, because it was poorly designed or because the amount of runoff was larger than had been foreseen and planned for;
- where demand is high and rainfall is low or irregular, large catchment areas and dams are needed;
- if the local soil and geographical conditions are not favourable, it may be expensive to transport the materials needed to construct the dam (e.g. clay, sand, gravel);
- catchment areas are unsuitable if there is no proper site for the dam or reservoir, such as when the ground does not provide a strong enough foundation for the dam and does not prevent seepage;
- the dam or reservoir will be too large (and expensive) if the depth-to-surface ratio is too small, or if percolation or evaporation losses are too great;
- the investment in labour, cash and/or kind needed to implement and/or maintain the surface harvesting systems may be beyond the capacity of communities;
- if densely-populated centres or important infrastructures are located downstream of a potential construction site for a dam, security reasons may rule out using the site;
- the taste of drinking-water varies between catchment areas and this can affect whether users accept the system, since they value the taste of drinking-water highly.

3.4 Springwater collection¹

3.4.1 The technology

Springwater is groundwater that surfaces naturally. Where solid or clay layers block the underground flow of groundwater, it is forced upward and can come to the surface. Springwater may emerge either in the open as a spring, or invisibly as an outflow into a river, stream, lake or the sea. Springwater is usually fed from a sand or gravel, water-bearing, ground formation (aquifer), or from water flowing through fissured rock. If the collection point is protected with a suitable structure, this will prevent contamination at the point of collection and provide the hydraulic conditions for distributing the water to points of use. The main parts of a springwater collection system are:

- a drain under the lowest natural water level;
- a protective structure at the source, for stability;
- a seal to prevent surface water from leaking back into the stored water.

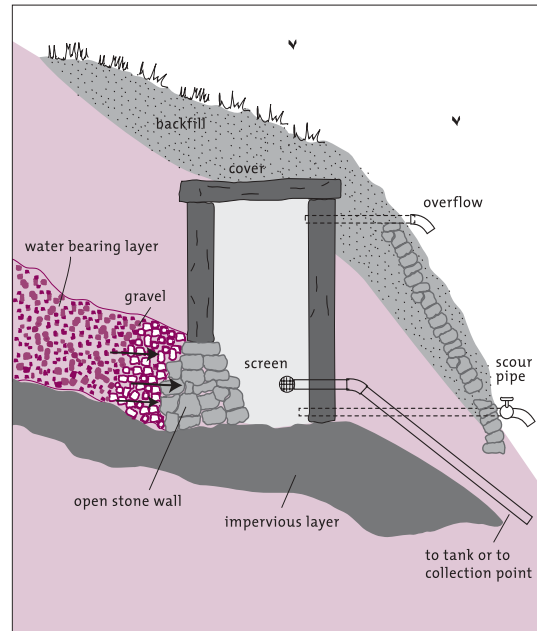

Figure 3.4 Springwater collection

The drain is usually placed in a gravel pack covered with sand, and may lead to a conduit or a reservoir. The protective structure may be made of concrete or masonry, and the seal is usually made of puddled clay and sometimes plastic. A screened overflow pipe guarantees that the water can flow freely out of the spring at all times. To prevent contamination by infiltration from the surface, a ditch (known as the interceptor drain) diverts surface water away from the spring box, and a fence keeps animals out of the spring area. Usually, springwater is of good quality, but this should be checked. In one case, the springwater came from a polluted stream that had gone underground; in another, the catchment area was contaminated. Unprotected springs are almost always contaminated at the outlet.

Initial cost: Capital costs vary considerably and depend on many factors. In Nepal, a relatively large spring box serving 150 households (with facilities for washing clothes) was constructed for about US\$ 1000, including costs for unskilled labour (Rienstra, 1990). In Kenya, minor structures for an average of 110 people were constructed at a cost of US\$ 200, the price including a headwall, backfill, fencing, and labour and transportation costs. Major spring structures for an average of 350 people cost about US\$ 400, also including a spring box (Nyangeri, 1986).

Yield: From less than 0.1 litres/s to many litres/s.

Area of use: Springwater collection systems are constructed on site, often by local craftsmen.

¹ Jordan (1984); Nyangeri (1986); WEDC (1991).

3.4.2 Main O&M activities

In many cases, springs are communally owned. Users may need to establish an organization that can effectively deal with issues, such as the control or supervision of water use, preventing water contamination, O&M activities, financing O&M, and monitoring water quality and systems performance. Proper management may also contribute to preventing social conflict over these and other issues. Someone who lives or farms near the spring site could be appointed to carry out O&M tasks at the site. If users obtain water at or near the site, this person could also be made responsible for water allocation and be involved in monitoring activities. His or her authority should be clear and accepted by all users.

The main O&M activities are:

- water should be allowed to flow freely all the time, to prevent it from finding another way out of the aquifer;
- opening or closing valves, to divert the water to a reservoir, a conduit or a drain;
- keeping the spring and surrounding areas clean.

Contamination should be prevented, both where the springwater infiltrates the ground, and in the area immediately surrounding the spring. Contamination can come from many sources, including from open defecation, latrines, cattle, pesticides and chemicals. The following tasks are envisaged:

- check surface drains;
- check and repair animal-proof fences and gates;
- check and protect the vegetative cover, both where the springwater infiltrates the ground, and in the immediate surroundings of the spring;
- prevent vegetative growth in the immediate surroundings of the spring, since the roots can clog the aquifer.

Water flow from the spring box should be checked. If there is an increase in turbidity or flow after a rainstorm, the contaminating surface run-off has to be identified and the protection of the spring improved. If the water flow decreases, it is likely that the collection system has become clogged. It may be necessary to replace the gravel or, in the case of a seep collection system, to clean the collection pipes. The following tasks are common:

- regular water samples must be taken and analysed for evidence of faecal contamination;
- the washout should be opened annually and the accumulated silt removed;
- screens should be checked and if they are damaged or blocked they should be cleaned (if dirty) or replaced with non-rusting materials (e.g. copper or plastic screening);
- after cleaning, the washout valve should be fully closed and the seal on the man-hole cover replaced;
- the spring box should be disinfected each time a person has entered to clean or repair it;
- the effluent water should be disinfected, especially if there is a likelihood of bacteriological contamination;
- leaks in the protective seal must be repaired, as must damage caused by erosion or by the soil settling, which could undermine the headwall.

3.4.3 Actors and their roles

Actors	Roles	Skills required
Users.	Report malfunctions, keep the site clean, assist in major repairs.	☺
Caretaker.	Keep the site clean, check for damage, perform small repairs.	✂
Water committee.	Organize bigger repairs, control the caretaker's work.	✂✂
Mason.	Repair masonry or concrete.	✂✂
External support.	Check the water quality, guide and motivate local organization.	✂✂✂

☺ Simple (often requires gender-specific awareness-raising, and training activities to change behaviour and build capacity);
 ✂ Basic skills. ✂✂ Technical skills. ✂✂✂ Highly qualified.

3.4.4 O&M technical requirements

Activity	Materials and spare parts	Tools and equipment
Weekly		
— clean the well surroundings.		Broom, bucket, hoe, machete.
Regularly		
— check the water quality.	Laboratory chemicals.	Laboratory equipment.
Occasionally		
— check the water quantity;		Bucket, watch.
— repair the fence and clean surface drains;	Wood, rope, wire.	Machete, axe, knife, hoe, spade, pickaxe.
— repair the piping and valves.	Spare pipes and valves, cement, sand, gravel.	Bucket, trowel, wrench, flat spanners.
Annually		
— wash and disinfect the spring;	Chlorine.	Bucket, wrench, brush.
— repair cracks.	Cement, sand, gravel, clay.	Bucket, trowel, hoe, spade, wheelbarrow.
After each flood		
— check turbidity.		

3.4.5 Potential problems

- the spring box collapses owing to poor design, construction errors, large surface run-offs, or damage caused by people or animals;
- leaks occur in the box, taps or valves;
- the springwater becomes contaminated because of cracks in the seal, or because of inappropriate behaviour by the users;
- piping becomes damaged because of faulty construction, abuse or corrosion;
- surface runoff, outflow or wastewater do not drain properly;
- pipes become clogged because of silting or plant roots;
- poor accessibility for water users;
- the springs may not deliver enough water, or become dry during certain parts of the year;
- not all springs produce clean water and of acceptable taste;
- the springs may be too far from the households or on privately-owned land;
- some springwater may be corrosive.

3.5 Dug well¹

3.5.1 The technology

A dug well gives access to a groundwater aquifer and facilitates its abstraction. Dug wells can be entered for cleaning or deepening, and they will rarely be less than 0.8 m in diameter. There are two main types of dug wells:

Unprotected wells. These are hand-dug holes that are not usually lined and have no effective protection above ground. As a result, they are very susceptible to contamination. Unprotected wells will not be further discussed in this Fact Sheet.

Protected wells. These are wells that are dug by hand or by machinery, and consist of the following main parts:

- a stone, brick or concrete apron;
- a headwall (the part of the well lining above ground) at a convenient height for collecting water;
- a lining that prevents the well from collapsing.

The apron prevents polluted water from seeping back down the sides of the well, provides a hard standing area for users, and directs spillage away from the well to a drainage channel. The covered headwall prevents spilt water, rainfall, runoff, debris, people and animals from entering or falling inside the well and keeps sunlight out.

The well lining between the ground level and the water level is made of reinforced concrete rings, masonry with bricks or concrete blocks, etc., and prevents the well from collapsing. The well lining beneath the water level also facilitates the entry of groundwater into the well, and is usually perforated with small holes, or has a different composition (e.g. permeable concrete) from the lining above the groundwater level. In consolidated formations the lining may not be necessary. In such cases, at least the top one metre of the well should be lined to prevent any contaminated surface water from draining into the well.

Other components often found in a protected well are:

- a drain to guide spilt water farther away from the well, usually towards a soakaway filled with large stones where the water can infiltrate back into the ground, or evaporate from the stone surfaces at a safe distance from the well;
- a fence that surrounds the well, with a gate for access.

The expected life of a modern dug well is at least 50 years.

Initial cost: Capital costs vary considerably and depend on many factors. In the Sahel region, the average cost for a dug well 1.8 m in diameter and 20 m deep (5 m under water) was about US\$ 8200 (Debris & Collignon, 1994). In Ghana, an 8 m-deep well with an apron cost US\$ 820 (Baumann, 1993a).

Range of depth: From a few metres to over 50 m.

Yield: About 5 m³ per day is good.

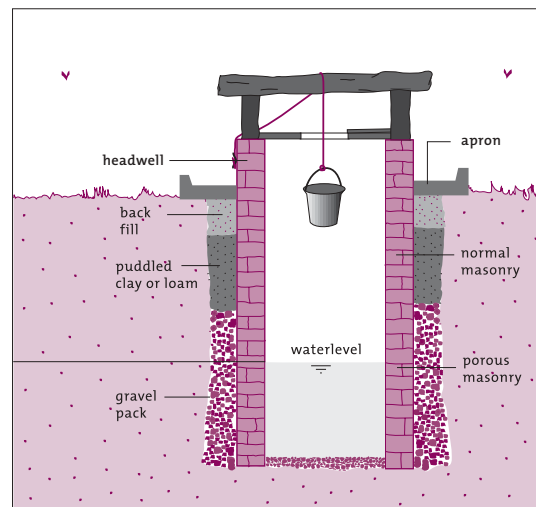

Figure 3.5 Protected dug well

¹ Nyangeri (1986); WEDC (1991); Debris & Collignon (1994).

Area of use: Areas where water of adequate quality can be abstracted in sufficient quantity throughout the year from an aquifer within about 50 m from the surface (sometimes deeper), and where other water systems are less suitable.

3.5.2 Main O&M activities

Maintenance activities may include:

- checking the well daily and removing any debris in the well;
- cleaning the concrete apron;
- checking the fence and drainage, and repairing or cleaning as needed;
- draining the well at the end of the dry season by taking as much water out as possible, removing debris from it and cleaning off algae using a brush and clean water, repairing where necessary, and then disinfecting the well;
- deepening and lining the well (if it has run dry or does not yield enough water);
- checking the concrete apron and the well lining above groundwater for cracks or other ruptures and repairing them if necessary;
- checking the apron for signs of erosion or settling, which could undermine it.

No latrines or other sources of contamination should be constructed within 30 m of the well, unless hydrogeological studies demonstrate that it is safe to do so. Maintenance can normally be carried out by the users of the system, or by a caretaker or watchman; larger repairs may require skilled labour, which can usually be provided by local craftsmen. When the wells are for community use, the community may need to establish a water committee to deal with issues such as: controlling or supervising water use; preventing water contamination; carrying out O&M activities; financing O&M; and monitoring the water quality. Proper management of communal wells is important and can help to prevent social conflicts. With individual wells, O&M is arranged by the users themselves.

Because the number of O&M activities required is limited and usually costs little, they should not be overlooked and should be given ample attention. For example, many wells have been abandoned because they were contaminated or had collapsed owing to a lack of maintenance. With regular O&M, it might be possible to restore some of these wells to use for relatively little cost.

3.5.3 Actors and their roles

Actors	Roles	Skills
Water user.	Keep the site clean, assist with major maintenance tasks.	☺
Caretaker.	Monitor water use, keep the site clean.	✳
Water committee.	Supervise the caretaker, organize major maintenance, collect fees.	✳
Mason.	Repair the lining, headwall and apron of the well.	✳✳
Specialized well-builder.	Deepen the well.	✳✳
External support.	Check the water quality, motivate and guide users' organization.	✳✳✳

☺ Simple (often requires gender-specific awareness-raising, and training activities to change behaviour and build capacity);
 ✳ Basic skills. ✳✳ Technical skills. ✳✳✳ Highly qualified.

3.5.4 O&M technical requirements

Activity and frequency	Materials and spare parts	Tools and equipment
Daily		
— clean the well site.		Bucket, broom.
Annually		
— clean the well;		Brush, bucket, ropes.
— repair the apron, headwall and drain.	Cement, sand, gravel, bricks.	Trowel, bucket, wheelbarrow, spade.
Occasionally		
— repair the lining;	Cement, sand, gravel, bricks, etc.	Trowel, bucket, wheelbarrow, ropes.
— disinfect the well;	Chlorine.	Bucket.
— deepen the well and extend the lining;	Cement, sand, gravel, bricks, concrete rings, etc.	Pump, bucket, ropes.
— repair the fence;	Wood, nails, wire, mesh.	Axe, saw, machete, hammer, pliers, etc.
— clean the drain.		Hoe, spade, bucket, wheelbarrow.

3.5.5 Potential problems

- the well collapses because it is not lined, is old, or is not properly maintained;
- the well runs dry, or yields fall, because their construction did not take into account the lower water levels during the dry season;
- water is abstracted at a higher rate than the natural recharge rate of the well;
- the lower lining of the well becomes clogged, reducing the inflow of groundwater;
- the groundwater becomes contaminated, either directly via the well, or by pollutants seeping into the aquifer through the soil;
- the construction of the well can depend on hydrogeological conditions, such as the presence, depth and yield of an aquifer, and whether rock formations are above them;
- wells should not be constructed too far from the users' households, or be too difficult to reach, or they will not be used sufficiently or maintained;
- wells can become contaminated if they are sunk closer than 30 m to latrines or places where cattle gather (this distance may be smaller if hydrogeological conditions and gradient allow it), although staying beyond this distance is no guarantee that contamination will not occur;
- the investment in labour, cash or kind needed to construct an improved dug well may be beyond the capacity of a community;
- even if a community has the financial means, it may be difficult to make available the skilled labour, tools, equipment and materials needed for construction and maintenance activities (such as draining the well);
- the wells may not be used exclusively for drinking-water, and may also be used as a source of irrigation water.

When discussing the potential of a well with a community, it is important to point out the effect it would have on water availability and all the possible uses for the water. Wider interest in the well could be gained by designing the apron to include clothes washing and bathing facilities, and by diverting wastewater to vegetable plots, etc.

Some advantages of dug wells over most drilled wells are:

- dug wells can often be constructed with locally-available tools, materials and skills;
- if the water-lifting system breaks down and cannot be repaired, a dug well can still work with a rope and bucket;
- dug wells can be deepened further if the groundwater table drops;
- dug wells have a greater storage capacity;
- dug wells can be repaired and de-silted by the community;
- dug wells can be constructed in formations where hand or mechanical drilling is difficult or impossible.

3.6 Drilled wells¹

3.6.1 The technology

Drilled wells, tubewells or boreholes give access to ground-water aquifers and facilitate abstraction of the water. They differ from dug wells in that the diameter is generally smaller, between 0.10–0.25 m for the casing. This does not allow a person to enter for cleaning or deepening. The well is usually the most expensive part of a handpump drinking-water supply project. Boreholes can be constructed by machine or by hand-operated equipment, and usually consist of three main parts:

- A concrete apron around the borehole at ground level (with an outlet adapted to the water abstraction method). This prevents surface water from seeping down the sides of the well, provides a hard standing, and directs lost water away from the well to a drainage channel.
- A lining below the ground, but not going into the aquifer, to prevent it from collapsing, especially in unconsolidated formations. The lining is usually pipe material (mostly PVC and sometimes galvanized iron). In consolidated formations, the lining may not be required.
- A slotted pipe below water level, to allow groundwater to enter the well. A layer of gravel surrounding the slotted pipe facilitates groundwater movement towards the slotted pipes and prevents ground material from entering the well. In consolidated formations this gravel may not be required.

The long-term performance of the well can be improved considerably with the proper combination of slot size, gravel filter and aquifer material, and extensive sand pumping before the well is brought into production.

Initial cost: Capital costs vary considerably and depend on many factors. The initial cost for a 50 m-deep hand-drilled well in the alluvial plains in South Asia can be as low as US\$ 200 (Arlosoroff et al., 1987). More recent data indicated that typical costs for a 50-m drilled well were US\$ 770 in India, and US\$ 10 000 in Mozambique (Wurzel & de Rooy, 1993).

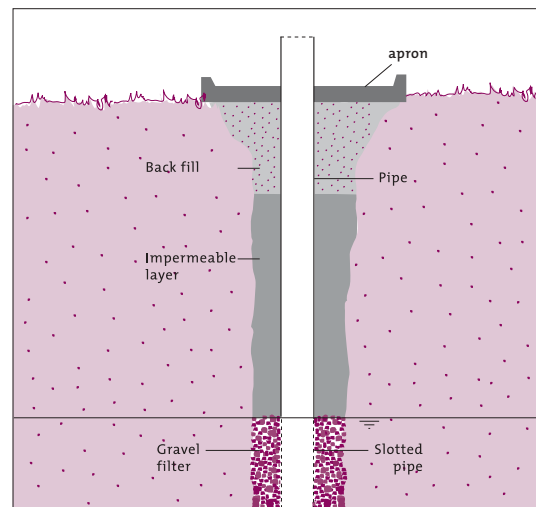

Figure 3.6 Drilled well

¹ Morgan (1990); Wurzel & de Rooy (1993); Debris & Collignon (1994).

Depth: From a few metres to over 200 m.

Yield: From less than 0.3 litres/s to more than 10 litres/s.

Expected life: Greater than 25 years.

Area of use: In areas with suitable aquifers.

3.6.2 Main O&M activities

Apart from cleaning the platform/apron daily, occasionally cleaning the drain, and repairing the fence (if present), there are few other maintenance activities. If a well has to be de-silted or rehabilitated, a specialist company will be required for the work and all appliances will have to be removed. There are various rehabilitation techniques, such as forcing air or pumping water into the well, brushing, and treating with chemicals. It is difficult to deepen an existing drilled well. Users may need to establish a local committee or agency that can deal with issues, such as controlling or supervising water use, preventing water contamination, carrying out O&M activities, financing O&M, and monitoring the water quality. Although the number of O&M activities required is limited and they usually cost very little, they should be given careful attention, as many wells are abandoned because a lack of maintenance allows them to become contaminated or to collapse.

3.6.3 Actors and their roles

Actors	Roles	Skills required
Water user.	Keep the site clean, assist with major maintenance tasks.	☺
Caretaker.	Monitor water use, keep the site clean.	✘
Water committee.	Supervise the caretaker, organize major maintenance, collect fees.	✘
Specialized well company.	Rehabilitate the well.	✘✘✘
External support.	Check the water quality, motivate and guide users' organization.	✘✘✘

☺ Simple (often requires gender-specific awareness-raising, and training activities to change behaviour and build capacity);
✘ Basic skills. ✘✘✘ Highly qualified.

3.6.4 O&M technical requirements

Activity and frequency	Materials and spare parts	Tools and equipment
Daily		
— clean the well site.		Broom, bucket.
Occasionally		
— clean the drain;		Hoe, spade, wheelbarrow.
— repair the fence.	Wood, nails, wire, etc.	Saw, machete, axe, hammer, pliers, etc.
Annually		
— repair the platform/apron.	Cement, sand, gravel.	Trowel, bucket.
Very rarely		
— rehabilitate the well.	Gravel, pipe material, etc.	Special equipment.

3.6.5 Potential problems

- the water is of poor water quality, or the well collapses due to corrosion of the galvanized iron lining;
- poor water inflow because the well was inadequately developed;
- soil particles enter the well because of inadequate screens or because the well was developed incorrectly;
- the well becomes contaminated because the well apron was designed or constructed incorrectly, or because well maintenance has been neglected;
- the borehole collapses because there is no lining or the lining is not strong enough;
- the construction of the well depends on hydrogeological conditions, such as the presence, depth and yield of aquifers, and the presence of rock formations above them;
- the well is constructed too far from the users' households, or is too difficult to reach, and is not used sufficiently or maintained adequately;
- the well is drilled near latrines, or where cattle gather (the recommended minimum distance is 30 m, but could be closer depending upon hydrogeological conditions);
- the well is used both for drinking-water and irrigation (this should be considered when assessing the development potential of wells with the community).

3.7 Subsurface harvesting systems¹

3.7.1 The technology

Subsurface harvesting systems retain groundwater flows and facilitate their abstraction. There are two main systems:

Subsurface dams: an impermeable dam is built across a surface aquifer, such as the bed of a seasonal sand-filled river, and based on top of an impermeable layer. The crest of the dam is about one metre beneath the ground surface, which prevents the land becoming waterlogged.

Raised-sand dams: an impermeable dam is built across the bed of a seasonal sand-filled river, with the crest reaching a few decimetres above the upstream river bed. Each time the upstream part of the river fills with sand, the crest is raised a little more to build up a groundwater reservoir. Eventually, the dam may be considerably higher than the downstream river bed. The downstream base of the dam should be protected against erosion with concrete or large boulders.

Both dam types have wing walls embedded in the river banks, against which rocks may be piled up to prevent erosion. Water can be abstracted by a well a short distance upstream of the dam, or by a drain system which collects water from the upstream base of the dam and leads it to the downstream side to a well or gravity-pipe system. Where possible, a flushing valve is installed to facilitate cleaning of the subsurface reservoir.

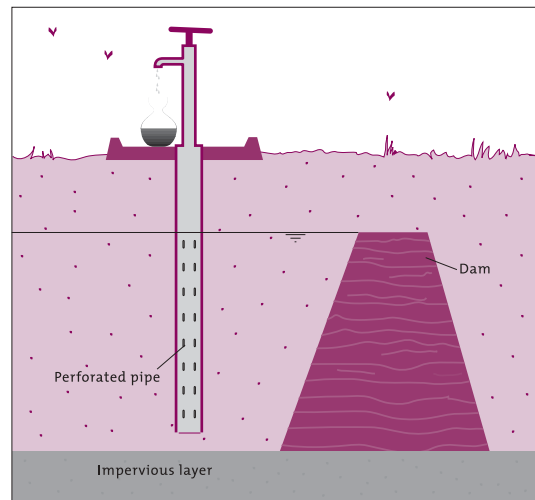

Figure 3.7 Subsurface dam

¹ Nilsson (1988); Lee & Visscher (1990, 1992).

Initial cost: A 3500 m³ dam costs US\$ 2.40/m³ in Kenya and US\$ 3.90/m³ in Tanzania (Lee & Visscher, 1990).

Yield: This depends on the catchment area, precipitation, etc.

Area of use: In many dry, monsoon and tropical wet-and-dry climate areas, and places where other improved water-supply systems are more difficult to build, or provide insufficient amounts of water, or provide water of poor quality.

3.7.2 Main O&M activities

- the well or gravity pipe should be regularly cleaned;
- after each large flood, any damage to the dam should be repaired and the dam protected with large stones if necessary;
- during the dry season, raised-sand dams should be raised by a maximum of 50 cm if the reservoir has filled up;
- for big repairs, such as when a dam has been undermined by infiltration, or damaged by a flood, many people and heavy machinery may be needed, and specialist technicians should be consulted.

Maintenance can normally be carried out by the users of the system or by a caretaker or watchman. Larger repairs may require skilled labour, which can usually be provided by local craftsmen. In some cases, unskilled labour may be required on a large scale (e.g. for repairing a broken raised-sand dam, or a leaking subsurface dam). The labour may be provided by the users (with or without pay), or by other people who are hired for the purpose.

Users may need to establish a local committee to manage issues, such as controlling or supervising water use, preventing water contamination, carrying out O&M activities, financing O&M, and monitoring how much stored water is still available (a piezometer or auger hole may be installed to allow a caretaker or watchman to estimate how much water is left and decide if rationing has to be introduced). Proper management may also help to prevent social conflict. For O&M tasks at the dam site, a person who lives or farms near this site could be appointed. This person could also be responsible for water allocation and be involved in monitoring activities, if users obtain the water near to, or at, the site. His or her authority should be clear and accepted by all users.

3.7.3 Actors and their roles

Actors	Roles	Skills required
Water user.	Participate in preventive maintenance.	☺
Caretaker.	Operate the valves, perform small repairs.	✂
Mason.	Perform repairs.	✂✂
Water committee.	Supervise the caretaker, organize major maintenance.	✂✂
Specialized technician.	Lead activities to make major repairs on the dam.	✂✂✂
External support.	Motivate and guide organization.	✂✂

☺ Simple (often requires gender-specific awareness-raising, and training activities to change behaviour and build capacity);

✂ Basic skills. ✂✂ Technical skills. ✂✂✂ Highly qualified.

3.7.4 O&M technical requirements

Activity and frequency	Materials and spare parts	Tools and equipment
Regularly		
— raise the crest of the dam.	Cement, sand, gravel, bricks, stones, reinforcement bars, wood, nails, etc.	Trowel, bucket, spade, hoe, pick axe, wheelbarrow, hammer, etc.
After flooding		
— check the dam for damage.		
Occasionally		
— clean the gravity pipe and/or well;		Broom, bucket, brush, trowel.
— place boulders at the base of the dam;	Boulders.	Pick-axe, hoe, spade, rope, poles.
— repair the drains, well or valves;	Cement, sand, gravel, drain pipe, spare valve.	Trowel, bucket, spade, hoe, pick-axe, wrench, screwdriver, spanner.
— repair the dam.	Cement, sand, gravel, reinforcement bars, clay, boulders.	Trowel, bucket, spade, hoe, pick-axe, wheelbarrow, hammer, etc.

3.7.5 Potential problems

- water losses may occur through cracks in the impermeable layer (it may be possible to drill a well in the fracture zone and utilize the dam as an artificial recharge structure);
- the dam may become undermined or eroded owing to faulty design or construction, such as when boulders are not used in the building of the dam;
- the river may change course;
- the possible dam construction sites may be too far from the water users.

Subsurface harvesting is inappropriate where the resulting rise of the water-table could have a negative impact on, for instance, agriculture, infrastructural works, or buildings. To some degree, subsurface water-harvesting systems improve water quality by filtering the water as it moves to the drains.

3.8 Protected side intake¹

3.8.1 The technology

A protected side intake provides a stable place in the bank of a river or lake, from where water can flow into a channel or enter the suction pipe of a pump. It is built to withstand damage by floods and to minimize problems caused by sediment. Side intakes are sturdy structures, usually made of reinforced concrete, and may have valves or sluices to flush any sediment that might settle. Often, a protected side intake is combined with a weir in the river to keep the water at the required level, a sand trap to let the sand settle, and a spillway to release excess water. The river water may

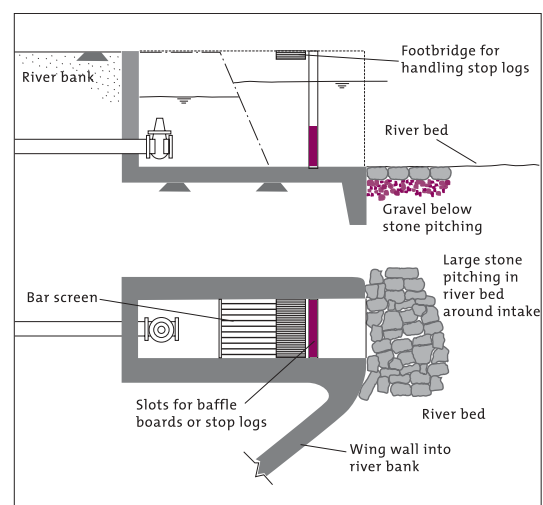

Figure 3.8 Protected side intake

¹ Lauterjung & Schmidt (1989); WEDC (1991).

enter the side intake through a screen, and a spillway overflow may be provided. Sometimes, protected side intakes are combined with a dam and a flushing sluice, which allows the upstream part of the river to be flushed.

Initial cost/yield: These will depend on the size of the intake, etc.

Area of use: Rivers and lakes.

3.8.2 Main O&M activities

- operation of a protected side-intake system is usually carried out by a caretaker;
- a valve or a sluice may have to be adjusted daily, the inlet to the channel or pump checked for obstructing debris, and any damage repaired;
- preventive maintenance, including painting the screens and other metal parts, such as sluices or valves;
- the intake canal and silt trap may have to be de-silted, debris cleaned from the screens regularly, and damaged screens should be welded;
- during the rainy season, the inlet may need checking and cleaning more frequently;
- any erosion of the river bank or bed must be repaired immediately with boulders, rocks, sandbags, etc.;
- cracks in the concrete structure should be repaired every year;
- annual cleaning and major repairs (these may require the assistance of the water users);
- after flooding, cleaning may be necessary.

3.8.3 Actors and their roles

Actors	Roles	Skills required
User.	Assist in cleaning and major repairs.	☺
Caretaker.	Inspection, cleaning, small repairs.	☺ and ✘
Mason.	Repair cracks in the concrete.	✘✘
Blacksmith.	Repair the screens.	✘✘

☺ Simple (often requires gender-specific awareness-raising, and training activities to change behaviour and build capacity);
✘ Basic skills. ✘✘ Technical skills.

3.8.4 O&M technical requirements

Activity and frequency	Materials and spare parts	Tools and equipment
Daily		
— inspect the inlet;		
— adjust the valve or sluice.		
Occasionally		
— clean the inlet canal and screen;		Rake, hoe.
— repair the screen;	Steel, cement, sand, gravel, nuts and bolts, welding electrode or oxyacetylene torch.	Welder, spanners.
— repair erosion damage.	Bags, sand, boulders, rocks, etc.	
Annually		
— paint metal parts;	Paint.	Steel brush, paint brush.
— repair cracks in concrete.	Cement, sand, gravel.	Trowel, chisel, hammer, bucket, wheelbarrow.

3.8.5 Potential problems

- clogging by silt or debris;
- the side-intake system may be undermined by river currents;
- the river or lake water may be polluted.

3.9 River-bottom intake¹

3.9.1 The technology

River-bottom or Tyrolean intakes for drinking-water systems are usually used in small rivers and streams where the sediment content and bed load transport are low. The water is abstracted through a screen over a canal (usually made of concrete and built into the river bed). The bars of the screen are laid in the direction of the current and sloping downwards, so that coarse material cannot enter. From the canal, water enters a sand trap and then may pass a valve and flow by gravity, or be pumped into the rest of the system.

Initial cost: Depends on the size of the system.

Yield: Up to 100% of the water flow of the river.

Area of use: Rivers with little sediment and bed load.

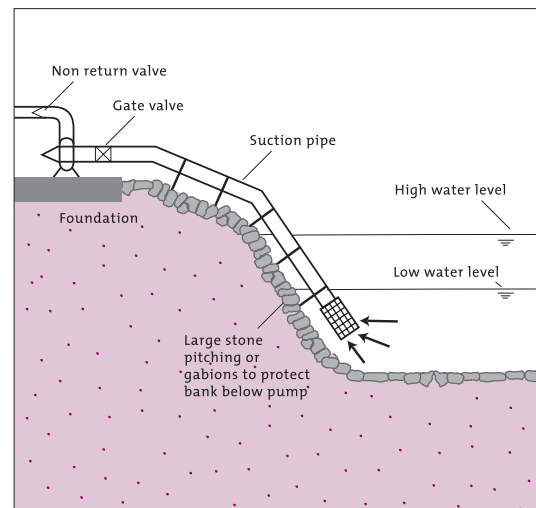

Figure 3.9 River-bottom intake

3.9.2 Main O&M activities

A river-bottom intake is usually operated by a caretaker. The inlet must be checked regularly and obstructing debris removed and any damage repaired. The sand trap must be cleaned regularly. Preventive maintenance consists of painting the screens and other metal parts, such as sluices or valves. Depending on silt and bed load transport, the sand trap and screen will have to be cleaned regularly, and the screen or valve may need repairing. Any erosion undermining the structure must be repaired immediately. Every year, the concrete structure should be checked for cracks and repaired if needed. The water users may be required to help with annual cleaning and major repairs.

3.9.3 Actors and their roles

Actors	Roles	Skills required
Users.	Assist with major repairs.	☺
Caretaker.	Inspection, cleaning, small repairs, operation of valves.	☺ and ✂
Mason.	Repair cracks in concrete.	✂✂
Blacksmith.	Repair screens.	✂✂

☺ Simple (often requires gender-specific awareness-raising, and training activities to change behaviour and build capacity);
 ✂ Basic skills. ✂✂ Technical skills.

¹ Jordan (1984); Lauterjung & Schmidt (1989); WEDC (1991).

3.9.4 O&M technical requirements

Activity and frequency	Materials and spare parts	Tools and equipment
Daily		
— inspect the inlet;		
— adjust the valve or sluice.		
Occasionally		
— clean the screen;		Rake, hoe.
— repair the screen;	Steel rods, cement, sand, gravel, nuts and bolts, welding electrode or oxyacetylene torch.	Welder, spanners.
— repair erosion damage.	Bags, sand, boulders, rocks, etc.	
Annually		
— paint the metal parts;	Paint.	Steel brush, paint brush.
— repair cracks in concrete.	Cement, sand, gravel.	Trowel, chisel, hammer, bucket, wheelbarrow.

3.9.5 Potential problems

- clogging by silt or debris;
- undermining by river currents;
- the river or lake water may be polluted;
- during the dry season, there may not be enough water in the river or stream to supply all users.

3.10 Floating intake¹

3.10.1 The technology

Floating intakes for drinking-water systems allow water to be abstracted from near the surface of a river or lake, thus avoiding the heavier silt loads that are transported closer to the bottom during floods. The inlet pipe of a suction pump is connected just under the water level to a floating pontoon that is moored to the bank or bottom of the lake or river. The pump itself can be located either on the bank or on the pontoon. The advantages of placing the pump on the pontoon are that the suction pipe can be quite short and the suction head will be constant (less risk of cavitation). For a description of typical pumps, see Chapter 4, *Water-lifting devices*. If the river currents frequently carry logs or large debris, a floating inlet needs extra protection or it will be damaged. To construct the pontoon, a steel or wooden frame can be attached to floats made from empty oil drums, plastic containers, or sealed steel tubes at least 30 cm in diameter.

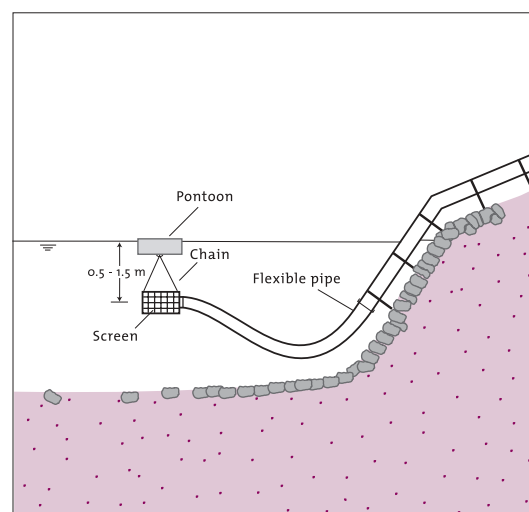

Figure 3.10 Floating intake

¹ Hofkes & Visscher (1986).

Initial cost: No data are available.

Yield: Will depend on the pump.

Area of use: Rivers or lakes.

3.10.2 Main O&M activities

A floating-intake system is usually operated by a caretaker. The pump and inlet pipe must be checked before and during pump operation, and any obstructing debris removed and damage repaired. This is particularly important during the rainy season. Every day, the mooring cables should be checked and adjusted if necessary, and the flexible pipe connections checked for leaks. Any damage to the mooring or the pontoon structure must be repaired immediately, which may require the assistance of several people. Depending on the materials used, the pontoon should be painted regularly, at least once a year for steel parts. For maintenance of the pump and turbine see Chapter 4, Water-lifting devices.

3.10.3 Actors and their roles

Actors	Roles	Skills required
Caretaker.	Clean the screen, check structure and mooring, perform small repairs.	✱
Blacksmith.	Repair the pontoon structure.	✱✱

✱ Basic skills. ✱✱ Technical skills.

3.10.4 O&M technical requirements

Activity and frequency	Materials and spare parts	Tools and equipment
Daily		
— check the pipe connections;		
— inspect the inlet.		
Occasionally		
— clean the inlet;		
— repair the inlet;	Mesh, wire.	Pliers, tin cutter.
— repair/replace pipe connections;	Flax, Teflon tape, spare connectors, nipples.	Pipe wrench, spanners.
— repair the pontoon;	Nails, bolts, nuts, welding electrodes or oxyacetylene torch, rope, wire.	Spanners, hammer, pliers, welder, knife.
— replace cables.	Steel cables, wire, cable clamps.	Spanners, steel saw, pliers.
Annually		
— paint the pontoon.	Paint.	Steel brush, paintbrush.

3.10.5 Potential problems

- floating objects collide with the floating pontoon;
- the pipe connectors between the pontoon and the bank wear out;
- the lake or river water may be of poor quality.

3.11 Sump intake¹

3.11.1 The technology

In a sump intake, water from a river or lake flows through an underwater pipe to a well or sump from where it is lifted, usually into the initial purification stages of a drinking-water system. The inflow opening of the underwater pipe is located below the low-water level and is screened. A well provides a place for sedimentation to settle and protects the pump against damage by floating objects. To facilitate cleaning, two sump intakes are sometimes built for one pump.

Initial cost: This can be as low as the cost of the pipe and the labour involved.

Yield: Depends on the design.

Area of use: On the banks of rivers and lakes.

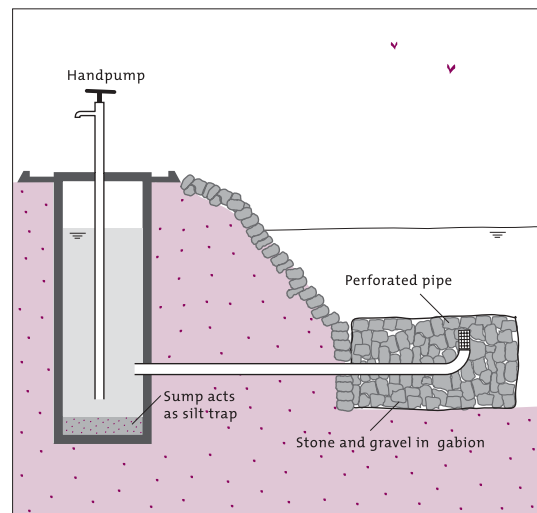

Figure 3.11 Sump intake

3.11.2 Main O&M activities

Operation is usually carried out by a caretaker. The sump must be checked daily for sufficient water inflow; any debris obstructing it must be removed, and any damage repaired. Most of the maintenance will be to the pump. The intake itself needs some cleaning and de-silting. If it caves in, or if the river or lake bank erodes, repairs have to be made. A sump inlet does not require special organizational arrangements.

3.11.3 Actors and their roles

Actors	Roles	Skills
Users.	Assist in cleaning and repairs.	😊
Caretaker.	Check the inlet, perform small repairs.	🔧

© Simple (often requires gender-specific awareness-raising, and training activities to change behaviour and build capacity);

🔧 Basic skills.

3.11.4 O&M technical requirements

Activity and frequency	Materials and spare parts	Tools and equipment
Daily		
— inspect the inlet.		
Occasionally		
— clean the inlet;		Rake or stick, spade.
— repair the inlet;	Screen, pipe, boulders.	Pickaxe, hoe, spade, metal cutter, saw, file etc.
— repair erosion damage.	Boulders, wood, cement, sand.	Hoe, spade, pickaxe, wheelbarrow.
Annually or more		
— de-silt the sump.		Hoe, spade, bucket, rope, etc.

¹ Lauterjung & Schmidt (1989); WEDC (1991).

3.11.5 Potential problems

- silt or debris clogs the inlet pipe;
- erosion caused by the river current undermines the intake structure and the bank;
- the water quality from the river or lake is poor;
- a sump intake is unsuitable for rivers that are very shallow or that have low flow rates.

4. Water-lifting devices

4.1 Introduction

Water-lifting devices are used to lift water to a height that allows users easy access to water. Lifting devices can be used to raise groundwater, rainwater stored in an underground reservoir, and river water. Communities should be able to choose from a range of water-lifting devices, and each option should be presented with its advantages, disadvantages and implications. For example, water lifting involves additional O&M activities and potential problems, compared to gravity systems, and the latter are often preferred if they are available and applicable to the situation.

The following water-lifting devices are described in this manual:

- rope and bucket (loose through a pulley, or on a windlass);
- bucket pump;
- rope pump;
- suction plunger handpump;
- direct action pump;
- deep-well piston pump;
- deep-well diaphragm pump;
- centrifugal pump;
- electrical submersible pump;
- axial flow pump;
- hydraulic ram pump.

There are other water-lifting devices that are not described in this manual, such as the progressing cavities pump, the manual diaphragm suction pump, the treadle pump and the chain pump. Other devices, such as the air-lift pump, are not included because they are not applicable to drinking-water supply systems.

4.2 Rope and bucket¹

4.2.1 The technology

This device is mainly used with hand-dug wells. A bucket on a rope is lowered into the water. When the bucket hits the water it dips and fills, and is pulled up with the rope. The rope may be held by hand, run through a pulley, or wound on a windlass. Sometimes, animal traction is used in combination with a pulley. Improved systems use a rope through a pulley, and two buckets – one on each end of the rope. For water less than 10 m deep, a windlass with a hose running from the bottom of the bucket to a spout at the side of the well can be used. However, the hygiene of this system is poorer, even if the well is protected.

Initial cost: From US\$ 6 for a plastic bucket and 5 m of rope, to US\$ 150 with a windlass, hose and closed superstructure, in Liberia (Milkov, 1987).

¹ Morgan (1990).

Range of depth: 0–15 m (or more sometimes).

Yield: 0.25 litres/s at 10 m.

Area of use: All over the world.

4.2.2 Main O&M activities

The bucket is lowered and raised by playing out and pulling in the rope, or by rotating the windlass. Care must be taken to prevent the rope or bucket from becoming soiled. Preventive maintenance consists of greasing the bearings of the windlass or pulley.

Small repairs are limited to patching holes in the bucket and hose, reconnecting the hinge of the bucket, and fixing the windlass bearings or handle. All small repairs can be done by local people, and with tools and materials available in the community or area. Major repairs and replacements mainly consist of replacing the bucket, hose, rope, or part or all of the windlass. Woven nylon ropes may last for two years, but twined nylon or sisal ropes last only a few months. A good-quality hose may last for over two years, and most buckets last a year (depending on the material and quality). When people use their own rope and bucket, no extra organization is required. For community wells, a community committee usually organizes the maintenance and cleaning of the well, maintenance of the windlass, etc. Most repairs can be paid with ad hoc fund-raising. For maintenance of the well, see Fact Sheet 3.5.

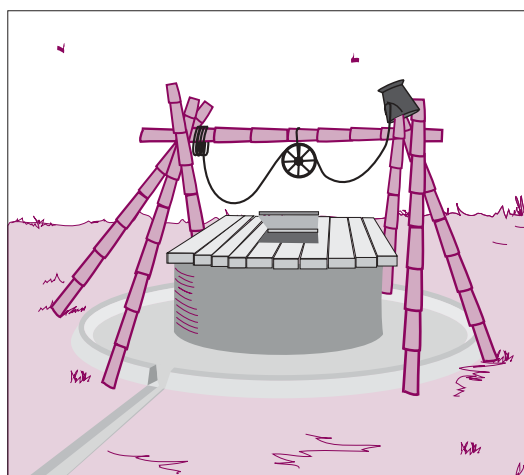

Figure 4.2 Rope-and-bucket lifting device.

4.2.3 Actors and their roles

Actors	Roles	Skills required
Users.	Lower and lift the bucket, keep the site clean, warn when the system malfunctions.	☺
Caretaker.	Keep the site clean, carry out small repairs.	✂
Water committee.	Organize cleaning of the well, collect fees.	✂
Local artisan.	Repair the bucket, windlass, well cover, etc.	✂✂
Shopkeeper/trader.	Sell the rope, buckets, etc.	☺
External support.	Check the water quality, motivate and guide local organization.	✂✂

☺ Simple (often requires gender-specific awareness-raising, and training activities to change behaviour and build capacity);
 ✂ Basic skills. ✂✂ Technical skills. ✂✂✂ Highly qualified.

4.2.4 O&M technical requirements

Activity and frequency	Materials and spare parts	Tools and equipment
Every two weeks		
— grease the axles of the windlass or pulley.	Grease or oil.	Lubricator.
Every year		
— replace the bucket.	Bucket, wire.	Knife.
Every two years		
— replace the rope.	Rope, wire.	Knife.

4.2.5 Potential problems

- poor-quality rope deteriorates quickly (e.g. sisal rope lasts for only a few months);
- the bucket falls into the well – to prevent this, communities can keep a spare bucket and fit the bucket into a protective cage, such as that described by Carty (1990);
- the hose breaks frequently in windlass-and-hose systems;
- poor hygiene, especially when the rope or bucket touches users' hands or the ground;
- communal wells tend to become more contaminated than family-owned wells, and the latter should be promoted whenever possible;
- the rope-and-bucket system is only suitable for limited depths.

4.3 Bucket pump¹

4.3.1 The technology

The bucket pump is mainly used in drilled wells. It consists of a windlass over a 125 mm PVC tube, down which a narrow bucket with a valve in the base is lowered into the water on a chain. When the bucket hits the water, the valve opens and the water flows in. When the bucket is raised, the valve closes and the water is retained in the bucket. To release the water, the pump operator rests the bucket on a water discharger, which opens the valve in the base. The windlass bearings are made of wood.

Initial cost: Estimated starting price is US\$ 80.

Range of depth: 0–15 m.

Yield: Relatively low and depends on well depth.

Trademarks: Developed by Blair Research Laboratory.

Area of use: Zimbabwe and elsewhere.

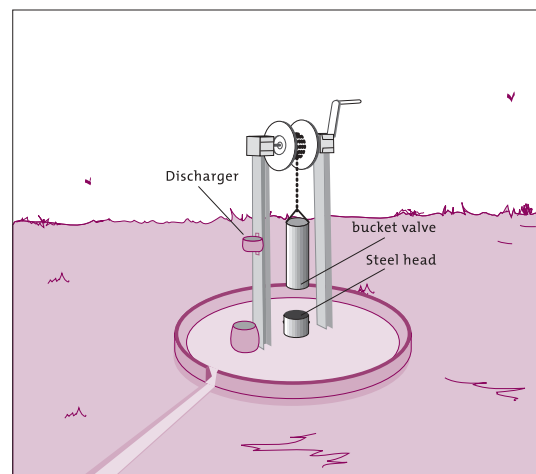

Figure 4.3 Bucket pump

4.3.2 Main O&M activities

To operate a bucket pump, rotate the handle of the windlass and let the bucket pass through the steel head. Both adults and children can operate the pump. Preventive maintenance consists of lubricating the wooden bearings of the windlass, checking the nuts and bolts, and checking that the valve is functioning. The pump and its environment should be kept clean, and the well should be disinfected regularly. Minor repairs consist of replacing the valve washers and repairing links in the chain. Broken links in the chain can be repaired with steel wire. If the chain has fallen into the tubewell it can be hooked out with a long piece of wire. A major requirement is repairing the bottom of the bucket, which can be done locally by a tinsmith or blacksmith. At some stage, the chain, the bucket or the bearings of the windlass will need to be replaced. A local craftsman may be needed to repair or replace the windlass system. Usually, village committees are formed to drill or dig the well, and install the pump. The committee can also organize mainte-

¹ Morgan (1990).

nance activities and collect fees for repairs. After the pump is installed, simple lessons in O&M should be given, followed by monitoring, and occasional assistance by external agencies.

4.3.3 Actors and their roles

Actors	Roles	Skills required
Users.	Keep the site clean; warn in case of malfunction.	☺
Local caretaker.	Ensure proper use of the pump; carry out regular maintenance; perform simple repairs; keep the site clean.	☺ / ✘
Water committee.	Check the work of the caretaker; raise funds for repairs.	✘
Tin worker or blacksmith.	Repair the chain and bucket.	✘✘

☺ Simple (often requires gender-specific awareness-raising, and training activities to change behaviour and build capacity);
✘ Basic skills. ✘✘ Technical skills.

4.3.4 O&M technical requirements

Activity and frequency	Materials and spare parts	Tools and equipment
Daily		
— clean the area.		Broom.
Weekly		
— tighten the bolts.	Nuts and bolts.	Flat spanner.
Occasionally		
— lubricate bearings;	Grease or oil.	
— replace bearings;	Hardwood.	Spanner.
— change the chain;	Chain, steel wire.	Two spanners.
— repair the bucket;	Spare valve/edge unit.	Saw, hammer, pliers.
— change the bucket;	Bucket.	Two spanners.
— repair the valve;	Washer or old car tube, bolts, split pin or wire.	Knife, two socket spanners (long and short).
— repair the platform.	Cement, sand, gravel.	Bucket, trowel.

4.3.5 Potential problems

- loose valve parts;
- broken chain;
- stones thrown in the well by children;
- low discharge rates;
- contamination, especially with communal wells;
- chlorine for disinfecting the well may not be locally available.

4.4 Rope pump¹

4.4.1 The technology

The basic parts of a rope pump are a pulley wheel above the well, a riser pipe from under the water level to an outlet just under the wheel, and a rope with rubber or plastic washers. The rope comes up through the pipe, over the wheel, back down into the well and into the bottom of the pipe, completing the loop. When the wheel is turned, the washers move upwards and lift water into the pipe towards the outflow. Other important parts are an underwater rope-guide that directs the rope and washers back into the pipe, and a frame that holds the pulley wheel. The rope pump can be made at village level using wood, rope and PVC tubing (or bamboo canes with the centres bored out).

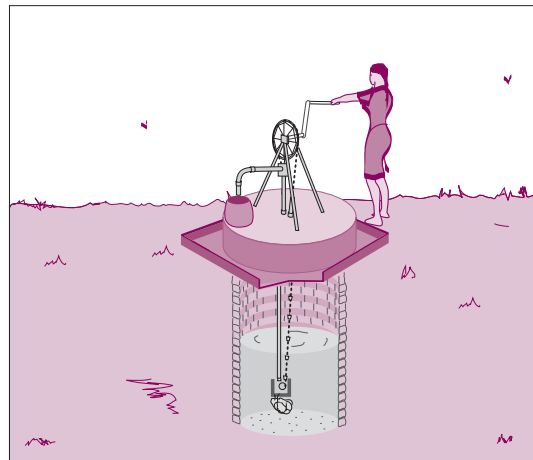

Figure 4.4 Rope pump

In Nicaragua, local industries produce an improved type of rope pump that has a metal wheel and frame, industry-made washers, and a guide block of concrete with ceramic and PVC tubes. About 25 000 of these pumps have been installed in Nicaragua. Water can be lifted from as deep as 50 m and raised to 5 m above ground level. Special models with 3-inch boreholes, and powered by windmills, bicycles, animal traction, electric motors or small gasoline engines, give good results.

Initial cost: US\$ 15–35 for a traditional model and US\$ 90 for a commercial model with piping (1995 data, Nicaragua).

Range of depth: 0–50 m.

Yield: 0.6 litres/s at 10 m, 0.15 litres/s at 50 m.

Area of use: In rural and periurban areas of Nicaragua, Bolivia, Indonesia, Ghana, Burkina Faso and other countries.

Construction: Local manufacturers/artisans.

4.4.2 Main O&M activities

The rope pump can be operated by men, women or children. Turning the handle of the pulley wheel makes the water rise. After pumping, the wheel has to be held for a moment to drain the water in the riser pipe and to prevent the washers from being pulled back in the pipe, which would cause extra wear. The site and the pump must be kept clean.

Depending on use and the type of bearings, the axle bearings must be greased at least once a week. The pulley wheel and other parts of the pump have to be checked regularly and fixed, as necessary. The rope must also be checked for excessive wear. Users should pay attention to the pump performance and report problems. Most problems occur with the rope or washers getting stuck, or slipping over the pulley wheel. Every 6 months to 3 years, the rope should be replaced (which takes about half an hour). Every few years, the washers should be renewed. The piping lasts for at least 6 years and, depending on the construction, maintenance and use, the frame and pulley wheel of the pump can last from 6 to 12 years. The rope guide should last for several years and to change it, the

¹ van Hemert et al. (1992); Lammerink et al. (1995).

rising main should be taken out (which can be done by hand by a few people). All repairs can be carried out by the users themselves, sometimes with the assistance of a craftsman for welding.

Rope pumps are used by communities or individual households. The maintenance needs are simple, but frequent, and users need to ensure that they are carried out and that their pump is kept in good working condition. Hygiene is more important than with many other types of pump, particularly when the pump is used communally. In such cases, it is important that the users organize effective measures for ensuring good hygiene practices.

4.4.3 Actors and their roles

Actors	Roles	Skills required
Users.	Pump the water, check that the pump is functioning properly.	☺
Caretaker.	Lubricate, check the rope, clean the site.	✘
Water committee.	Supervise the caretaker, collect fees.	✘
Local or area craftsman.	Repair the pulley and frame structure.	✘✘
External support.	Control the water quality, guide and motivate organization.	✘✘ / ✘✘✘

☺ Simple (often requires gender-specific awareness-raising, and training activities to change behaviour and build capacity);
✘ Basic skills. ✘✘ Technical skills. ✘✘✘ Highly qualified.

4.4.4 O&M technical requirements

Activity and frequency	Materials and spare parts	Tools and equipment
Weekly		
— grease bearings;	Grease or oil.	Lubricator.
— check the rope and frame structure.		
Occasionally		
— replace the guide block;	Wire, strips of inner tubing from car tyres, guide block, gravel, sand and cement.	Pliers, knife, hammer and chisel.
— repair the frame structure.	Wood and nails, or scraps of metal, and welding electrodes, or oxyacetylene torch.	Welding equipment or hammer, chisel and saw.
Annually		
— replace the rope;	Nylon rope.	Knife.
— paint the frame;	Anticorrosive paint.	Steel brush, paintbrush.
— repair the platform.	Cement, sand, gravel.	Trowel, bucket.
Every two years		
— replace the washers.	Washers or old car tyre.	Knife.
Every six years		
— replace the tubes.	PVC tubing, solvent cement.	Saw, file.

4.4.5 Potential problems

- the rope becomes worn because it is exposed to the sun (exposed rope needs to be protected), or because it is used heavily;
- the installation of the rope pump was poorly done and its performance is suboptimal;
- the pulley wheel malfunctions;
- the pistons, frame and guide block are of poor quality and do not function properly;
- traditional rope pumps have a lift of only about 10 m;
- users need to exercise care when using the pump as it is susceptible to contamination;
- although design and quality of construction may differ significantly, the rope pump can be low-cost, and operated and maintained at the village level.

4.5 Suction plunger handpump¹

4.5.1 The technology

A suction plunger handpump has its cylinder and plunger (or piston) located above the water level, usually within the pump stand itself. These pumps must be primed by pouring water on the plunger. On the up-stroke of the plunger, the pressure inside the suction pipe is reduced and atmospheric pressure on the water outside pushes the water up into the pipe. On the down-stroke, a check valve at the inlet of the suction pipe closes and water passes the plunger through an opened plunger valve. With the next upstroke, the plunger valve closes and the water is lifted up by the plunger and flows out at the top of the pump, while new water flows into the suction pipe. The operational depth of this type of handpump is limited by barometric pressure and the effectiveness of the plunger seals to about 7 m at sea level, less at higher altitudes.

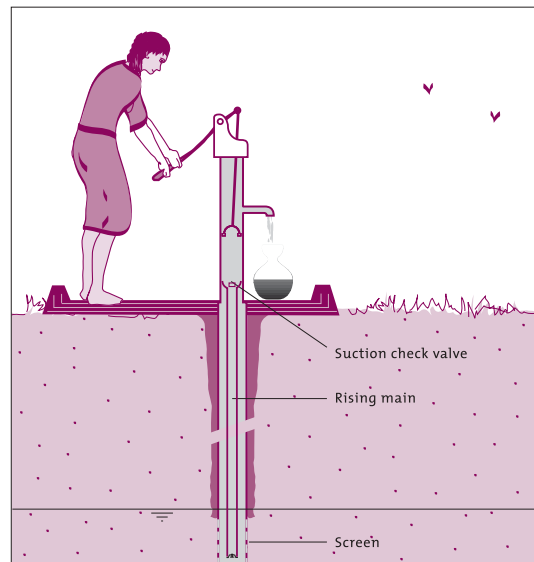

Figure 4.5 Suction plunger handpump

Initial cost: From US\$ 35 (Thailand, 1985), including 10 m galvanized iron drop pipe and a foot valve, to US\$ 185 for a Wasp pump in India (1983 price without a suction pipe) (Arlosoroff et al., 1987).

Range of depth: 0–7 m.

Yield: 0.4–0.6 litres/s at 7 m.

Area of use: Rural and low-income periurban areas where groundwater tables are within 7 m of the surface.

Trademarks: AID Suction; Bandung, Inalsa Suction; Jetmatic Suction; Lucky, New No. 6; Rower, SYB-100; Wasp, etc.

¹ Arlosoroff et al. (1987).

4.5.2 Main O&M activities

The operation begins with priming the pump, by pouring clean water on the plunger through the top of the pump stand. Pumping is done by moving the handle up and down, usually while standing beside the pump (with a rower pump, the user sits). Most suction handpumps can be easily operated by men, women and children.

Suction pumps are relatively easy to maintain, since most or all of the moving parts are above ground level. Maintenance can normally be done by a village caretaker or by the users themselves, using simple tools, and basic spare parts and materials (however, several brands cannot be completely maintained at local level). The basic skills needed for preventive maintenance (e.g. greasing, dismantling the pump stand, replacing spare parts, etc.) can be taught to pump caretakers quickly (from a few hours to a few days, depending on the complexity of the system, materials used, etc.). Preventive maintenance consists of greasing the bearings every week, inspecting the interior of the pump stand once a month, and inspecting the whole pump stand once a year. Most of this work can be done by one or two people, but more people may be needed when pump parts have to be lifted out of the well or borehole. During these inspections, smaller repairs (replacement of washers, etc.) may be necessary. For major repairs (e.g. broken rising main, cracks in the welding of metal parts), more highly skilled people and specialized tools and materials may be needed.

Many suction handpumps are family pumps and are cared for by one family. For communal pumps, the user group or community will need a local committee to organize O&M tasks, including making major repairs. Private enterprises sometimes play an important role in performing repairs and selling spare parts.

4.5.3 Actors and their roles

Actors	Roles	Skills required
Users.	Pump the water, warn of malfunctions.	☺
Local caretaker.	Ensure proper use of the pump and carry out regular maintenance, perform simple repairs, keep the pump and site clean.	✳
Water committee.	Check the work of the caretaker, collect contributions for maintenance and repairs.	✳
Area technician.	Perform major repairs.	✳✳
Local or area merchant.	Sell spare parts.	☺
External support.	Check water quality, motivate and guide the local water committee.	✳✳✳

☺ Simple (often requires gender-specific awareness-raising, and training activities to change behaviour and build capacity);

✳ Basic skills. ✳✳ Technical skills. ✳✳✳ Highly qualified.

4.5.4 O&M technical requirements

Activity and frequency	Materials and spare parts	Tools and equipment
Daily		
— clean the pump surroundings;	Clean water.	Bucket or can.
— check pump functioning;		
— clean the pump site.		Broom.
Weekly		
— grease pump-stand parts.	Oil or grease.	Lubricator.
Monthly		
— check pump-stand parts.		Spanners.
Occasionally		
— adjust loose bolts;		Spanners.
— replace pump-stand parts;	Washers, cupseals, bearings, etc.	
— repair broken parts.	Welding electrodes.	Spanners, pipe wrench, welder, file, etc., depending on the model.
Annually		
— check the entire pump;		Spanners, pipe wrench, etc., depending on the model.
— replace worn parts;	Washers, cupseals, bearings, etc.	Spanners, pipe wrench, etc.
— repair the platform.	Sand, cement.	Bucket, trowel.

4.5.5 Potential problems

- worn out washers, cupseals and bearings;
- excessive corrosion that causes pump rods to break, and leaks to appear in the rising mains;
- many pumps are of poor quality;
- the biggest drawback of suction pumps is that they can lift water to only about 7 m, and if the water table falls below that level, the pump becomes inoperable and must be replaced with a deep-well pump;
- contaminated water is often used to prime suction pumps;
- most pumps are designed for family use and are not sturdy enough for communal use.

4.6 Direct action handpump¹

4.6.1 The technology

Direct action handpumps are usually made of PVC and other plastics, and are installed on boreholes of limited depth. A plunger is attached to the lower end of a pump rod, beneath the groundwater level. The user moves the pump rod in an up-and-down motion, using a T-bar handle. On the up-stroke, the plunger lifts water into the rising main, and replacement water is drawn into the cylinder through the foot valve. On the down-stroke, the foot valve closes, and water passes through a one-way valve in the plunger and is lifted on the next up-stroke. Because direct action handpumps have no mechanical

¹ Arlosoroff et al. (1987); Morgan (1990); Reynolds (1992).

advantage, such as the lever or fly-wheel of a deep-well handpump, direct action pumps can only be used to depths from which an individual can physically lift the column of water (about 12 m). However, the mechanical simplicity, low cost and lightweight construction makes these pumps well equipped to meet O&M objectives at the village level.

Initial cost: From about US\$ 100 to over \$ 900 (1985 prices) (Arlosoroff et al., 1987). Models suitable for village level O&M cost less than US\$ 150.

Range of depth: 0–12 m.

Yield: 0.25–0.42 litres/s at 12 m depth.

Area of use: Rural and low-income periurban areas, where groundwater tables are within 12 m of the surface.

Trademarks: Blair; Ethiopia BP50; Malawi Mark V; Nira AF85; Tara; Wavin.

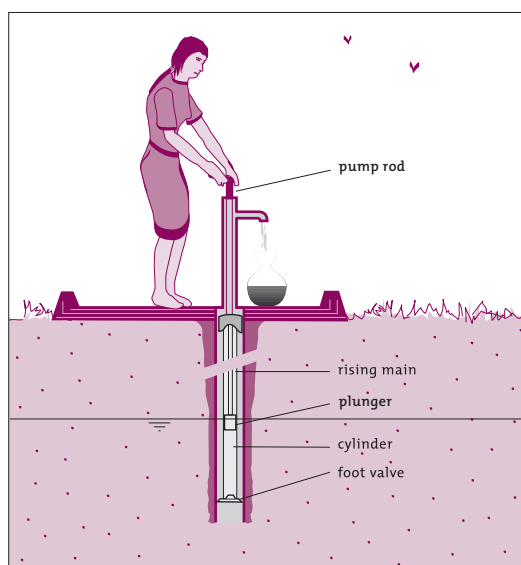

Figure 4.6 Direct action handpump

4.6.2 Main O&M activities

The pump is operated by moving a handle up and down. As the plunger is located underwater, no priming is needed. Adults, and even children, can pump the water, although if the water table is below 5 m, this may be difficult for children. The pump stand and site must be kept clean.

Maintenance of direct action pumps is relatively simple and can be taught to users or caretakers, sometimes within a few hours. For preventive maintenance, usually only one or two people are needed. Daily activities consist of checking the pump performance and the appearance of the water (if it is cloudy with silt, the borehole must be cleaned). Annually, the pump should be taken apart and checked. Small repairs include replacing worn cupseals and washers, straightening bent pump rods, and replacing corroded lock nuts. To carry out major repairs (e.g. a broken pump rod or rising main, cracks in the welding of metal parts), skilled help may be needed. O&M can be organized at community level, and since maintenance is relatively simple, good organization will result in a reliable service.

4.6.3 Actors and their roles

Actors	Roles	Skills required
Users.	Pump the water, keep the site clean, warn of malfunctions.	☺
Caretaker.	Keep the site clean, do small repairs, check pump annually.	✂
Water committee.	Organize maintenance, collect fees.	✂
Local merchant.	Sell spare parts.	☺
Local or area mechanic.	Perform major repairs.	✂✂
External support.	Check water quality, motivate and guide local organization.	✂✂✂

☺ Simple (often requires gender-specific awareness-raising, and training activities to change behaviour and build capacity);
 ✂ Basic skills. ✂✂ Technical skills. ✂✂✂ Highly qualified.

4.6.4 O&M technical requirements

Activity and frequency	Materials and spare parts	Tools and equipment
Daily		
— clean the pump and site;		Broom.
— check performance.		
Occasionally		
— replace cupseals and washers;	Cupseals, washers.	Spanners, screwdriver.
— replace pump rod and/or pump handle;	Pump rod, pump handle.	Spanners, wrench.
— replace cylinder and/or plunger and/or foot valve;	Cylinder, plunger, foot valve.	Spanners, wrench, screwdriver.
— repair rising mains.	PVC tubing, PVC solvent and sandpaper or galvanized iron tubing, teflon or hemp.	Saw and file, or two pipe wrenches.
Annually		
— check the whole pump;		Spanners, screwdriver.
— repair the pump platform.	Cement, sand, gravel.	Bucket, trowel.

4.6.5 Potential problems

- worn washers, plungers and foot valve parts;
- abrasion of the seal on the PVC cylinder and between the pump rod and rising main;
- broken or damaged handles;
- the maximum lift is limited to about 12 m;
- the force needed to pump the water may be too great for children, especially if the water table is below 5 m.

4.7 Deep-well diaphragm pump¹

4.7.1 The technology

Inside a cylindrical pump body at the bottom of the well, a flexible diaphragm shrinks and expands like a tube-shaped balloon, taking the water in through an inlet valve and forcing it out through an outlet valve. The cylindrical pump is connected to a flexible hose which leads the water to the surface. Movement of the diaphragm is effected by a separate hydraulic circuit that consists of a cylinder and piston in the pump stand, and a water-filled pilot pipe, which is also a flexible hose. The piston is moved, usually by pushing down on a foot pedal, although conventional lever handles may also be used. When foot pressure is removed, the elasticity of the diaphragm forces water out of it, back up the pilot



Figure 4.7 Deep-well diaphragm pump

¹ Arlosoroff et al. (1987); Fonseca & Baumann (1994).

pipe, and lifts the foot pedal. Deep-well diaphragm pumps are still being improved, but most imperfections have been corrected.

The principle of the pump is attractive because it allows thin flexible hoses to be used, making the pump easy to install or remove without the need for special tools or equipment. Replacing spare parts is usually easy; only the replacement of the diaphragm may need the assistance of a skilled mechanic. It is possible to install several pumps in a single well or borehole.

Initial cost: In 1986, a complete pump that operated to a depth of 30 m cost US\$ 860 (CIEH, 1990). In Burkina Faso and Benin in 1993, a Vergnet model pump cost US\$ 1460–1820 (including 10% VAT), depending on the installation depth (Baumann, 1993b).

Range of depth: 10–70 m.

Yield: 0.50 litres/s at 10 m depth; 0.32 litres/s at 30 m; and 0.24 litres/s at 45 m.

Useful life: Eight years.

Area of use: Burkina Faso, Cameroon, Ghana, Liberia, Mali, Mauritania, Niger.

Trademarks: Vergnet; ABI-ASM (no longer in production).

4.7.2 Main O&M activities

The pump is operated by pushing down on a pedal, usually by foot, but sometimes with a handle. Depressing the pedal can take a considerable effort, as much as the bodyweight of the user, and the pump must be built to withstand this.

Every day, the pump head, platform and surroundings must be cleaned, and the nuts and bolts tightened. Each month, the drive piston, rings and guide bushing need to be checked and replaced if necessary. At least once a year (more often if borehole conditions warrant it), the downhole parts of the pump have to be checked and the entire pump washed with clean water. The pump can be extracted from the well by the village caretaker and reinstalled, all within one-half hour. Only one spanner is needed to service the pump. Also, the plunger seals in the cylinder at the pump stand cost little and can easily be replaced by the pump caretaker.

In contrast, replacing the pump diaphragm is a major O&M activity. This must be done every two to five years, and some diaphragms come with a three-year guarantee. This activity requires a mechanic who has been trained in replacing pump diaphragms (some mechanics have even been able to repair ruptured diaphragms).

Deep-well diaphragm pumps are typically communal, and the water committee should appoint someone who lives near to the pump site to be caretaker. This person will need some training in maintenance and hygiene. The committee should be able to get in contact with the area mechanic quickly, and it must have the financial means to pay for repairs in cash. Often, the pump supplier provides maintenance backstopping.

4.7.3 Actors and their roles

Actors	Roles	Skills required
Users.	Pump the water, keep the site clean, report malfunctions.	☺
Caretaker.	Keep the site clean, perform small repairs.	✂
Area mechanic.	Replace the diaphragm.	✂✂
Water committee.	Supervise the caretaker, collect fees.	✂
External support.	Check water quality, motivate and guide local organization.	✂✂✂

☺ Simple (often requires gender-specific awareness-raising, and training activities to change behaviour and build capacity);
 ✂ Basic skills. ✂✂ Technical skills. ✂✂✂ Highly qualified.

4.7.4 O&M technical requirements

Activity and frequency	Materials and spare parts	Tools and equipment
Daily		
— clean the pump and site.		Broom, bucket.
Weekly		
— grease the parts of the pump stand.	Grease.	Lubricator.
Monthly		
— check the entire pump.		Spanner.
Occasionally		
— replace the piston parts;	Piston seal, pedal rod guide, etc.	Spanner.
— replace the inlet and outlet washers.	Washers.	Spanner.
Annually		
— repair the platform.	Sand, cement, gravel.	Trowel, bucket.
Every 3–5 years		
— replace the diaphragm.	Diaphragm.	Spanner.

4.7.5 Potential problems

- pedal rod guides and plunger seals need to be replaced frequently, and the plunger guides may wear out quickly;
- drive hoses often need to be re-primed because water leaks past the plunger seals, and the foot pedal then needs to be raised by hand;
- if solid particles enter the downhole pumping element it must be cleaned, since this will cause the diaphragm to stop working or even rupture;
- if a community cannot afford to replace the pump diaphragm, or if no skilled mechanic is available, users may be forced to return to their traditional sources, temporarily;
- moderate skills in steel fabrication and fitting are needed to produce a pump stand, while advanced manufacturing techniques and tight quality control are needed to produce the pumping element; in many countries, these parts will have to be imported.

4.8 Deep-well piston handpump¹

4.8.1 The technology

With a deep-well piston handpump, the piston is placed in a cylinder below the water level, which is usually 15–45 m below the ground. The pumping motion by the user at the pump stand is transferred to the piston by a series of connected pumping rods inside the rising main. On the up-stroke, the plunger lifts water into the rising main, and replacement water is drawn into the cylinder through a foot valve. On the down-stroke, the foot valve closes, and water passes the plunger and is lifted on the next up-stroke. The pumping height is limited only by the effort needed to lift the water to the surface. Nowadays, most pump cylinders have an open top. This allows the piston and foot valve to be removed through the rising main for servicing and repairs, while the rising main and cylinder stay in place. The pump rods have special connectors that allow them to be assembled or dismantled without tools, or with only very simple ones. The connecting joints incorporate pump rod centralizers that prevent wear of the rising main. To a large extent, improved models can be maintained at village level.

¹ Arlosoroff et al. (1987); Reynolds (1992).

Initial cost: In 1985, for a well 25–35 m deep, prices ranged from about US\$ 40 for a cylinder, plunger and foot valve set (installed under a locally-made pump head), to over US\$ 2300 for a complete pump with stainless steel parts (Arlosoroff et al., 1987). Most good pumps cost US\$ 300–500.

Range of depth: 15–45 m, although depths of up to 100 m are possible.

Useful life: 6–12 years.

Yield: 0.25–0.36 litres/s at 25 m, and 0.18–0.28 litres/s at 45 m depth.

Area of use: Rural and low-income periurban areas where groundwater tables are within 100 m (but preferably within 45 m) from the surface.

Trademarks: Afridev/Aquadev; Bestobell Micro; Bush pump; Blair pump; India Mark II and III; Kardia; Tropic (Duba); UPM; Volanta.

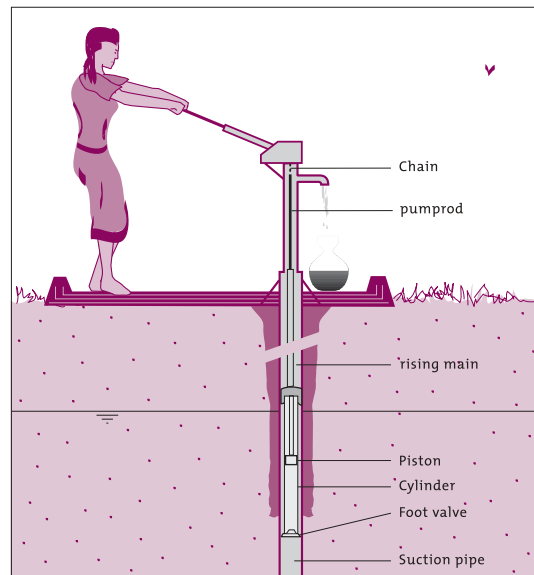

Figure 4.8 Deep-well piston handpump

4.8.2 Main O&M activities

The pump is operated by moving the handle up and down, or by rotating the handle of a flywheel. This can be done by adults and even children, since handle forces are usually kept within acceptable limits (depending on the brand and lifting heights). Preventive maintenance usually consists of checking that the pump is functioning, and cleaning the pump and pump site daily. Each week, the pump should be greased, and once a month all parts of the pumpstand must be checked. Small repairs include replacing bearings, cupseals and washers, and straightening bent pumping rods, etc.

Once a year, the entire pump should be dismantled for a check, the parts cleaned with clean water, and the pumpstand painted. Pump rods that show bad corrosion must be replaced. Under normal conditions, a galvanized steel pump rod needs to be replaced every five or six years. Rising mains made of galvanized iron should be removed and checked, and pipes with badly corroded threads replaced. Major repairs involve replacing the plunger, foot valve, cylinder, pump rods, rising main, pump handle, fulcrum, etc.

With open-top cylinder pumps, all preventive maintenance activities can normally be carried out by the pump caretaker for the village. With closed-top cylinder pumps, however, special lifting equipment may be needed to pull up the rising main and cylinder, so that pump parts down in the well hole can be maintained. Deep-well pumps can be too expensive for individual families, and they may be better suited to communal use. To maintain the pump in good working condition, communities will have to organize themselves, for example, by appointing a pump caretaker, or by coordinating activities through a pump committee. External support is often provided by state or nongovernmental organizations, but this can be costly. In some cases, small private enterprises, paid directly by the communities, are now doing this job satisfactorily.

4.8.3 Actors and their roles

Actors	Roles	Skills required
Users.	Pump the water, keep the site clean, report malfunctions.	☺
Caretaker.	Keep the site clean, check pump regularly, do small repairs.	✘
Water committee.	Supervise the caretaker, collect fees.	✘
Area mechanic.	Perform major repairs.	✘✘
External support.	Check water quality, and motivate and guide local organization.	✘✘✘

☺ Simple (often requires gender-specific awareness-raising, and training activities to change behaviour and build capacity);
 ✘ Basic skills. ✘✘ Technical skills. ✘✘✘ Highly qualified.

4.8.4 O&M technical requirements

Activity and frequency	Materials and spare parts	Tools and equipment
Daily		
— clean pump and site.		Broom, brush.
Weekly		
— grease bearings.	Grease or oil.	Lubricator.
Monthly		
— check the pumpstand parts.		Spanner.
Occasionally		
— replace the pumpstand parts;	Nuts and bolts, bearings, pump handle.	Spanners, screwdriver.
— re-mill the threads in the pump rod or main;	Oil.	Pipe threader, tackle.
— replace the foot valve, plunger or cylinder;	Foot valve, plunger or cylinder.	Spanners, wrench.
— replace the pump rod or main.	Pump rods or main tubing.	Spanners, wrench, pipe threader.
Annually		
— replace cupseals;	Cupseals.	Spanners, wrench, knife, screw driver, etc.
— repair the platform.	Gravel sand, cement.	Bucket, trowel.

4.8.5 Potential problems

- the most common repair is replacing the plunger seals;
- there can be problems with the quality control of local manufacturers, especially in African countries;
- the hook-and-eye connectors of the pump rods tend to break more often than conventional connections, and the rods may also become disconnected, or bend spontaneously;
- corrosion is a problem, especially where the groundwater is aggressive, and it can affect the pump rods if they are not made of stainless steel, the rising main (if not galvanized iron tubing), the cylinder, the housing for the pumphead bearing, and other pumpstand parts;
- handles become shaky or broken, mainly because of worn-out bearings;
- the number of problems usually increases with increasing depth of the groundwater (the maximum lift for a pump varies according to the brand, but is usually 45–100 m).

- with some pump brands, or when the water must be lifted from a great depth, the pump handle may require considerable strength to turn it;
- to reduce the number of major repairs, the rising main should be made of the highest-quality material available;
- rigorous quality control is needed for deep-well piston handpumps, since many are produced in developing countries;
- deep-well piston handpumps may require considerable torque to start them, and the pump may be driven by a windmill; as a result, rotary pumps are often preferred because of their lower starting torque.

4.9 Centrifugal pump¹

4.9.1 The technology

The essential components of a centrifugal pump are the fast-rotating impeller and the casing. Water flows into the centre “eye” of the impeller, where centrifugal force pushes the water outwards, to the casing. The kinetic energy of the water is partly converted to useful pressure that forces the water into the delivery pipe. Water leaving the central eye of the impeller creates a suction, which draws water from the source into the pump. An impeller and the matching section of the casing is called a “stage”. Several stages can be combined with a single shaft to increase the overall pressure (multiple-stage pump). The water passes through the successive stages, with an increase in pressure at each stage. Multiple-stage centrifugal pumps are normally used when water has to be pumped to a significant height (200 m or more). For deep-well applications, the centrifugal pump and electrical engine are housed in a single unit. When the unit is to be located under the water level, a submersible pump will be required (see section 4.10).

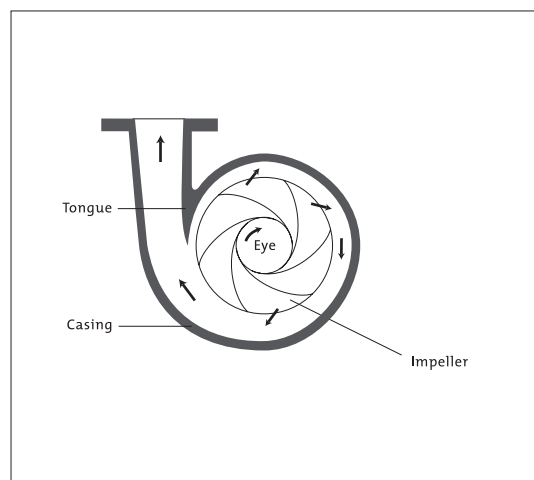

Figure 4.9 Centrifugal pump

One limitation of a centrifugal pump is that the suction height cannot be higher than about 7 m above the water level. To overcome this limitation, and make it possible to place the pump above the suction limit, some pumps inject a jet stream of water into the suction pipe inlet. The kinetic energy of the injected water is partly converted into extra pressure, which helps to lift the water above the suction limit of the pump.

Initial cost: Highly dependent on the power rating and quality of the pump.

Head range: Typically, 4–50 m per stage, with multiple-stage pumps to 200 m and more.

Yield: Varies widely, according to many options available in the market.

Area of use: Anywhere engine power is available.

Trademarks: Grundfos; Drysale; Sta-rite; and others.

¹ Fondation de l'Eau (1985); Fraenkel (1986); Pollak (1988); Castilla Ruiz & Galvis Castano (1993).

4.9.2 Main O&M activities

During pumping, the condition of the engine, the water output of the pump, and the temperature of bearings should be checked, and any vibration should be reported. In some systems, valves must be closed manually just before switching off the pump, to retain water in the system. Most centrifugal pumps are not self-priming, and if the pump house runs dry, clean water has to be poured into it.

The pump inlet should be maintained, and the pump and engine kept clean. A record of the pump running hours, problems, servicing, maintenance and repairs should be kept in a logbook. The pump should be dismantled annually, and the rising main removed from the well and inspected. The inlet screen, foot valve and pipe threads should be checked, and any corroded or damaged threads re-cut. Badly corroded pipes should be replaced. The foot valve may need a new rubber, or it may have to be replaced. All other repairs, such as replacing the bearings or the impeller, are costly and should be carried out by qualified technicians.

For several reasons, centrifugal pumps are not suitable for village-level maintenance. Pump maintenance requires an organization that focuses on the training and reliability of the pump caretaker, and on raising funds to support the pump O&M. In the event of breakdown, the pump committee must be able to mobilize a trained area mechanic quickly. Centrifugal pumps are designed for specific ranges of flow and pressure, and it is important that pump characteristics and operating conditions are matched by someone properly trained. The starting torque of a centrifugal pump is relatively low, which is an advantage for windmill and solar power applications.

4.9.3 Actors and their roles

Actors	Roles	Skills required
Users.	Occasionally assist the caretaker.	☺
Caretaker.	Operate engine and pump; check functioning; perform small repairs.	✂✂
Area mechanic.	Perform major repairs.	✂✂
External support.	Check water quality; motivate and guide the local committee.	✂✂✂

☺ Simple (often requires gender-specific awareness-raising, and training activities to change behaviour and build capacity);
 ✂✂ Technical skills. ✂✂✂ Highly qualified.

4.9.4 O&M technical requirements

Activity and frequency	Materials and spare parts	Tools and equipment
Regularly		
— clean the inlet.		Depends on the installation.
Occasionally		
— prepare the pump for use by priming it with clean water;	Clean water.	Funnel, bucket or can, spanner, wrench.
— replace the impeller;	Impeller.	Spanners, screwdrivers, special tools.
— replace the bearing.	Bearing.	Spanners, screwdrivers, special tools.
Annually		
— take the pump apart and clean it.		

4.9.5 Potential problems

- debris, sand or other particles may enter the pump, causing abrasion damage;
- an inlet becomes clogged, causing cavitation;
- the pipeline system is damaged by severe surges in water pressure, caused by starting and stopping the pump abruptly;
- the pump and engine are badly aligned, causing the bearings to wear out quickly;
- the main limitations of a centrifugal pump are its cost, the need to ensure a reliable supply of electricity or fuel, and the need for skilled technicians to maintain and repair the pump.

4.10 Submersible pump¹

4.10.1 The technology

For deep-well applications, centrifugal pumps are housed with the electric engine in a single unit that is designed to be submerged. Usually, a multiple-stage pump is used. The multiple-stage pump is placed above a motor and under a check valve that leads to the rising main. Submersible pumps are self-priming, if they do not run dry. To prevent the pump from running dry, the water level in the well must be monitored, and pumping must be stopped if the water level drops to the intake of the pump. Power is delivered through a heavily insulated electricity cable connected to a switch panel at the side of the well. The power may come from an AC mains connection, a generator, or a solar power system.

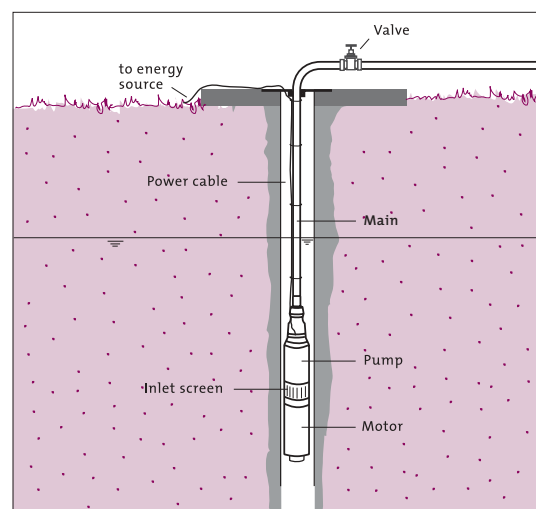

Figure 4.10 Submersible pump.

Initial cost: A pump for a 50–100 m head, and a flow rate of 10 m³/h, costs about US\$ 2500 (1995 prices); a pump for the same head range and an output of 45 m³/h costs about US\$ 7000 (UNDP/IAPSO, 1995).

Range of depth: 7–200 m or more.

Efficiency range: 40–70%.

Trademarks: Guinard; Goulds; Grundfos; KSB; Meyers; and others.

4.10.2 Main O&M activities

During pumping, the water flow and power consumption should be monitored. If the water is turbid only during the first stages of pumping, the rising main is corroding. If the turbidity continues after the first stages, the well must be cleaned or the pump will wear quickly. Running hours, problems, servicing, maintenance and repairs should be reported in a logbook.

The pump and rising main should be removed from the well and inspected annually. The inlet screen, check valve and pipe threads should be examined, and corroded or

¹ Fraenkel (1986); Pollak (1988); Castilla Ruiz & Galvis Castano (1993).

damaged threads re-cut. Badly corroded pipes should be replaced. Electric cables should be inspected, particularly the insulation between the cables. All other repairs, such as replacing a pump stage, involve high costs and must be carried out by a qualified technician. Submersible pumps are not suitable for village-level maintenance, although they can often function for years with hardly any maintenance. The local committee or water agency should focus on the training and reliability of the caretaker, on cost-recovery, and on being able to mobilize an area mechanic quickly, in case the pump breaks down.

4.10.3 Actors and their roles

Actors	Roles	Skills required
Users.	Occasionally, assist the pump caretaker.	☺
Caretaker.	Operate pump; check water quantity and clearness.	✂✂
Area mechanic.	Perform major repairs.	✂✂
External support.	Check water quality, motivate and guide the local committee/water agency.	✂✂✂

☺ Simple (often requires gender-specific awareness-raising, and training activities to change behaviour and build capacity);
 ✂✂ Technical skills. ✂✂✂ Highly qualified.

4.10.4 O&M technical requirements

Activity and frequency	Materials and spare parts	Tools and equipment
Annually		
— take the pump out of the well, clean the inlet screen and check the valve.		Rig, pulley, two pipe wrenches, screwdriver, spanner.
Occasionally		
— replace the fuse to the electric motor;	Fuse.	Screwdriver.
— replace the piping;		Rig, pulley, two pipe wrenches, screwdriver, spanner.
— replace the pump stages.		Rig, pulley, two pipe wrenches, screwdriver, spanner, specialized tools.

4.10.5 Potential problems

- sand or other particles may enter the pump and cause abrasion damage;
- the rising main may corrode;
- the pipeline system can be damaged by the severe pressure surges that result when the pump is started or stopped abruptly;
- the main limitations of a submersible centrifugal pump are its price, the need to maintain a reliable supply of electricity or fuel, and the high level of technology involved.

4.11 Hydraulic ram pump¹

4.11.1 The technology

Hydraulic rams (hydrams) are devices that pump water by using the shock energy of a flowing water mass that is suddenly forced to stop. They have to be installed at a lower level than the surface of the water source (e.g. a spring or stream). Only part of the water from the stream or spring is pumped higher. At the beginning of the pump cycle, water flows from the source down an inclined and rigid drive pipe (several metres long) into the hydram body and out through the impulse valve. When the water has accumulated enough velocity, it forces the impulse valve to close suddenly and the water in the drive pipe comes to a sudden stop. This produces

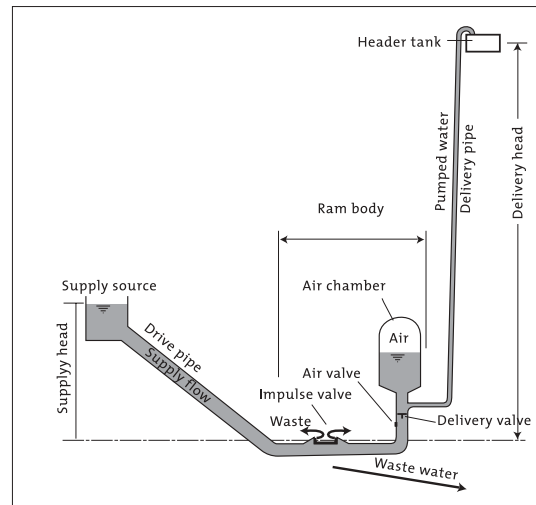

Figure 4.11 Hydraulic ram pump

a shockwave in the water mass, forcing an amount of water through the delivery valve (located in the pump body) into a buffering air chamber, and from there up the delivery pipe. The air is supplied by a small air-inlet valve in the pump body. In newer designs, the buffer chamber contains a piece of compressible rubber, instead of air. After the shockwave, the pressure in the pump body drops, the delivery valve closes, and the impulse valve is opened by the force of a spring or weight. The water in the drive pipe begins to flow through the impulse valve and the pump cycle starts again. Hydrams usually operate at 30–100 pumping cycles per minute. Compared to other pumps, their output is generally low, but the efficiency of newer designs has improved.

Initial cost: No data available.

Pumping head: 1–100 m (maximum is about 40 times the supply head).

Yields as percentage of inflow: 26% for a 2 m drop and 6 m lift; 5% for 3 m drop and 30 m lift.

Expected lifetime: 20–30 years.

Area of use: Rural areas where the water source falls by at least 1 m, and where little of the collected water is to be pumped higher than the water source.

Trademarks: Blake (UK); Cecoco (Japan); Las Gaviotas (Colombia); Premier (India); Rochfer (Brazil); Sano (Germany); Schlumpf (Switzerland); and others. Hydrams are also made in workshops.

4.11.2 Main O&M activities

Hydraulic rams have to be started by hand, by repeatedly opening the impulse valve until the pump continues to operate by itself. The weight or spring tension on the impulse valve may have to be adjusted to reach the right frequency. The pump inlet, pump and site must be kept clean.

The delivery valve must be checked weekly, to see that it is functioning properly, and bolts should be tightened. Occasionally, the pump will have to be dismantled and the

¹ Fraenkel (1986); Hofkes & Visscher (1986); Meier (1990); Mathewson (1993).

accumulated sand and silt removed. The frequency with which the rubbers of the valves have to be replaced will depend largely on the quality of the rubber. The valves and the valve spring may also wear out and, if the water is corrosive, the pump and drive pipe may need to be replaced sooner than expected.

Because of the low cost of a hydraulic ram pump and its intake works, this technology is suitable for communal use. A caretaker should be appointed for O&M, but little training is needed.

4.11.3 Actors and their roles

Actors	Roles	Skills required
Caretaker.	Check and start the pump, clean the pump, perform basic repairs.	☺
Water committee.	Supervise the caretaker, collect contributions.	✘
Area mechanic.	Replace the valves.	✘✘
External support.	Check water quality, motivate and guide the local organization.	✘✘✘

☺ Simple (often requires gender-specific awareness-raising, and training activities to change behaviour and build capacity);
✘ Basic skills. ✘✘ Technical skills. ✘✘✘ Highly qualified.

4.11.4 O&M technical requirements

Activity and frequency	Materials and spare parts	Tools and equipment
Daily		
— check that the pump is functioning.		
Weekly		
— check the delivery valve.		Spanner.
Occasionally		
— restart the hydram;		
— adjust the impulse valve;		Spanner.
— tighten the bolts;		Spanner.
— replace the valve rubbers;	Valve rubbers, old car tyre tube.	Spanner, screwdriver, knife.
— carry out major repairs;	Valves, valve spring.	Spanners, wrench, pipe threader.
— dismantle and clean the pump.		Spanner, wrench.
Annually		
— repair the inlet and platform.	Cement, sand, gravel.	Bucket, trowel.

4.11.5 Potential problems

- worn valve rubbers, sand and silt in the pump body;
- hydraulic ram pumps need a water supply that is at least one metre higher than the pump body;
- output is generally low with a hydraulic ram pump, particularly if the pumping lift is high and the amount of water pumped is only a fraction of that taken in through the drive pipe;
- besides the cost of the pump itself, there are the additional expenses for intake works, the drive pipe, the pump platform and the drain.

5. Power systems

5.1 Introduction

The preferred energy sources for water-supply systems in poor communities are manual effort, animal traction and gravity. Solar power and windmills are attractive alternatives because there are no energy costs, but they require greater capital investment, greater organization and a higher level of technical capacity than traditional power sources. Wind power may be a good option if there is wind throughout the year, with average monthly speeds exceeding 2.5 m/s. Solar power is a good alternative in areas with a lot of sunshine, where there is no electricity network, and where it is difficult to service internal combustion engines. Solar power is becoming more attractive as photovoltaic cells become more efficient.

If an engine-driven pump is chosen and there is a local electricity network, it is generally advisable to use an electric motor instead of an internal combustion engine, since the O&M of an electric motor is far less complicated.

The following power systems have been included in this manual, because they are of great interest in the sector today:

- windmill;
- solar systems;
- diesel engine.

The windmill and solar power systems were chosen as examples of alternative power systems, and the diesel engine as a conventional system.

5.2 Windmills¹

5.2.1 The technology

Windmills can provide the energy to move a pump. The most common models have a rotor fixed to a horizontal axis that is mounted on a steel tower. The tower of the windmill is usually 9–15 m high. Wind drives the rotor and this movement is transmitted to drive a pump (usually a piston type), either directly or via a gear box. A vane keeps the rotor facing the wind during normal wind speeds, but there is also a mechanism to position the rotor parallel to the wind to avoid damage to it from excessive wind

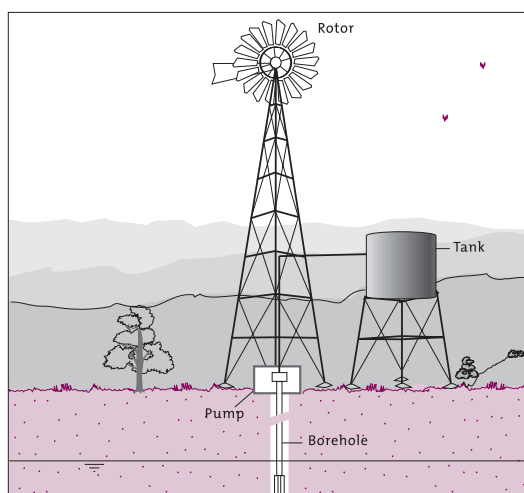

Figure 5.2 Windmill

¹ Hofkes & Visscher (1986); van Meel & Smulders (1989); McGowan & Hodgkin (1992).

speeds. Some windmills are fixed facing the wind, others are manually oriented, and some have a braking system.

The right combination of pump, windmill and wind characteristic is important for the success of this technology. To be economically feasible, the average monthly wind speed at rotor level should be 2.5 m/s (or more) during the whole pumping season. Because wind can be unreliable, it is recommended that there be water-storage facilities with enough water to last for 3–4 days.

In windy areas where fuel is expensive or the supply is unreliable, windmill pumps are a competitive alternative to diesel-driven pumps.

Initial cost: US\$ 200–500 per m² of rotor area, not including the tower (1989 prices, McGowan & Hodgkin, 1992).

Yield: For a normal windmill-driven pump at 3 m/s wind speed, the yield at a 10 m head is typically 0.12 litres/s per m² of rotor area.

Area of use: Rural areas where average wind speeds exceed 2.5 m/s.

Expected life: Twenty years or more.

Trademarks: Aeromotor; Dempster; Fiasa; Kijito; Southern Cross.

5.2.2 Main O&M activities

Operation is often automatic. Some windmills require manual release of the furling mechanism after excessive wind. When no pumping is needed, the windmill may be temporarily furled out of the wind by hand. Windmill and pump should be checked regularly and any abnormality corrected.

Every month, the windmill and pump must be checked visually. The bolts on the pumping rods tend to come loose, and loose nuts and bolts should be tightened, and moving parts greased, as necessary. Paintwork should be maintained annually, and the lubrication oil changed in the gear box (if one is used). Poor maintenance will lead to the bearings wearing out rapidly and the wind will then damage the rotor and other pump parts. Maintenance for a windmill-driven piston pump is comparable to that for a heavily-used handpump.

Usually, one person is responsible for the windmill, pump and storage system. This person has to be trained for the job and may receive a caretaker's fee. Good preventive maintenance may extend the life of a windmill to well over 20 years, while bad maintenance may cause serious damage within a year.

5.2.3 Actors and their roles

Actors	Roles	Skills required
Caretaker.	Check, tighten and lubricate moving parts; paint; manually furl and unfurl the windmill; warn a technician in case of damage.	✘
Area technician.	Replace bearings, rotor blades and other parts; repair furling mechanism, gear box, etc.	✘✘

✘ Basic skills. ✘✘ Technical skills.

5.2.4 O&M technical requirements

Activity and frequency	Materials and spare parts	Tools and equipment
Monthly		
— visually check the pump and windmill;		
— tighten nuts and bolts;		Spanners, wrench.
— lubricate the moving parts.	Oil or grease.	Lubricator, funnel, container for used oil, spanners.
Occasionally		
— repair the furling mechanism;	Special parts, nuts, bolts, rope.	Spanners, wrench.
— replace worn bearings.	Bearing.	Spanners, wrench, screwdriver.
Annually		
— paint the windmill.	Anticorrosive paint.	Steel brush, paintbrush.

5.2.5 Potential problems

- poorly-trained caretakers may accidentally block the furling mechanism, which can lead to the windmill being damaged in high winds;
- moving parts may wear out quickly, because they are inadequately lubricated;
- when wind speeds are lower than 2 m/s most windmills cannot pump, and many windmills are not economically viable when the average wind speed is below 3 m/s;
- to avoid problems with pump quality and performance, choose a local manufacturer or supplier with a proven track record, and who supplies a good-quality brand of windmill.

5.3 Solar power system¹

5.3.1 The technology

Photovoltaic (PV), or solar, cells convert the energy from light directly to electricity. The cells are shaped like thin squares, rectangles or circles, and are made from special materials such as silicon, germanium, selenium, etc. A number of solar cells wired together under a protective glass plate is called a module, which is the basic element a consumer can buy. Modules can be connected in parallel or series, according to the required voltage and current. A group of modules is called an array. It must be installed where it is completely exposed to sunlight and protected against damage by cattle or vandalism. The electricity produced by the modules may go directly to an engine or be stored in batteries.

System performance can be improved in several ways, such as by having the provider design the system for a specific application. For example, the pump and electric engine

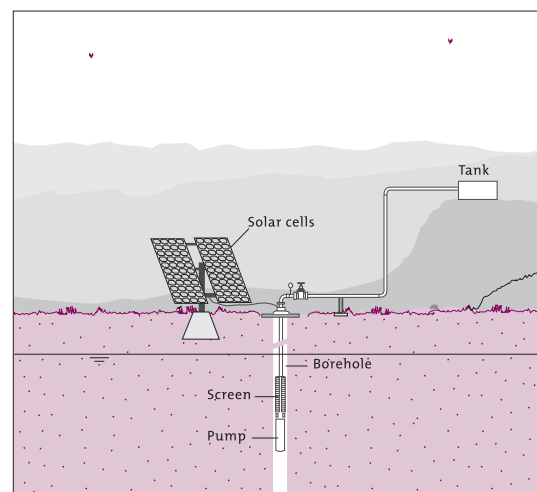

Figure 5.3 Photovoltaic system

¹ Derrick A, Francis C, Bokalders V (1991); McGowan & Hodgkin (1992); Neway (1992).

could be designed to be used with PV systems. To be economically feasible for pumping the daily average solar radiation at the site should be at least 3 kWh/m² for every month of the year. It is also recommended that at least a 3-day supply of water or or electricity be stored. Solar cells are becoming cheaper and more efficient.

Initial cost: US\$ 5–7 per watt (peak capacity for modules; wholesale price, 1995, Europe). Simple systems, with a 30 W pump and array, cost about US\$ 1000, but larger borehole systems may cost more than US\$ 50 000 (including all components, but excluding transportation and taxes).

Area of use: Where sufficient sunlight is available, especially for small-scale activities.

Expected life cycle: Eighteen years or more for modules.

Trademarks (complete systems): Grundfos; Mono; Heliodinamica; Fluxinos; Hydrasol; Kyocera, etc.

5.3.2 Main O&M activities

Dust must be removed from the glass plates of the module regularly. In addition, external wires, the supporting structure of the array, covers for the electronic components, and a fence may need occasional repairs. Wood or metal parts that are sensitive to corrosion must be painted every year. Much of the additional electrical and electronic equipment should function automatically for at least 10–15 years, although batteries, AC/DC converters, engines and pumps may need more frequent servicing.

Local organization can be very simple, consisting mainly of appointing a caretaker and collecting fees. However, an adequate number of technicians for repairing such systems must be available at regional or national level.

5.3.3 Actors and their roles

Actors	Roles	Skills required
Caretaker.	Wipe the modules clean; repair the fence, supporting structure and wires.	☺
Area or specialist technician	Perform major repairs.	***

☺ Simple (often requires gender-specific awareness-raising, and training activities to change behaviour and build capacity);
*** Highly qualified.

5.3.4 O&M technical requirements

Activity and frequency	Materials and spare parts	Tools and equipment
Regularly		
— clean the module surface.	Water.	Cloth, bucket.
Occasionally		
— repair or replace additional components;	Engine brushes, spare battery, AC/DC converter, other complete components.	Spanners, screwdriver, pliers, etc.
— repair the fence.	Wood, nails, wire.	Hammer, machete, pliers.
Rarely		
— repair the mounting structure;	Cement, wood.	
— repair the wiring.	Electricity cable, insulation tape.	Knife, pliers.

5.3.5 Potential problems

- vandalism, theft, or cattle damage to the cells, modules or system;
- the storage batteries wear out relatively quickly;
- the initial investment is high;
- the system is not feasible for areas with daily radiation amounts below 3 kWh/m².

5.4 Diesel generator¹

5.4.1 The technology

Diesel generators are frequently used as a stationary power source. The main parts of the engine are the cylinders, pistons, valves and crankshaft. Air is compressed by a piston inside a cylinder and diesel fuel is injected into it by a high-pressure pump, which results in an explosion that moves the piston. In turn, the piston turns a crankshaft, which can be put to use, for example, by driving a pump or electricity generator. Valves in the cylinder regulate the inflow of fuel and air, and the outflow of exhaust gases.

Diesel engines differ from petrol engines in that they do not have spark-plugs to ignite the fuel mixture, and work at much higher pressures. Diesel engines need less maintenance than petrol engines, and they are more efficient. Diesel engines can differ in size (from 1–6 cylinders or more) and speed (revolutions per minute), and by the number of engine cycles (2-stroke, or 4-stroke). In general, low-speed four-stroke engines last longer, and high-speed two-stroke engines produce more power per kg of engine weight. Water-cooled engines generally need less maintenance than air-cooled engines.

- diesel engines are well-suited for stationary, high-power output;
- with good maintenance they are dependable energy sources;
- it is important to select a brand that has a good reputation, and for which servicing and spare parts are locally available.

Initial cost: From US\$ 200 per kW for 25 kW engines, to US\$ 600 per kW for 2 kW engines (1990 data, installation and other costs not included; McGowan & Hodgkin, 1992).

Power range: Starts at 2 kW.

Life cycle: A diesel generator can operate for between 5000–50 000 hours (average 20 000 hours), depending on the quality of the engine, whether it has been installed correctly, and whether O&M has been properly carried out.

Area of use: Globally, especially for high-power needs and where no grid electricity is available.

Manufacturers: Kubota; Lister-Petter; Lambardini, etc.

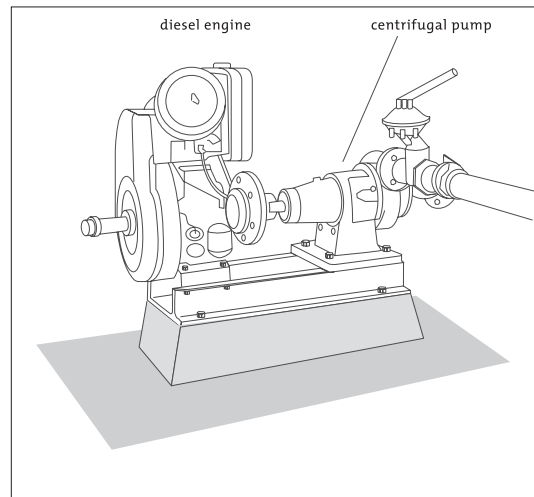

Figure 5.4 Diesel engine and centrifugal pump

¹ Carlsson & Drake (1990); van Winden (1990); McGowan & Hodgkin (1992).

5.4.2 Main O&M activities

A diesel engine must be operated by a trained caretaker, and every engine has its own operating instructions. Before starting the engine, the levels of fuel, oil and cooling water (if not air cooled) should be checked, and topped up if any are low. During operation, the caretaker should check the fuel level and oil pressure, and that the pump and generator are functioning properly. Some moving parts may need to be lubricated manually. The engine speed should also be checked, because if it is too low, the engine will have a low efficiency and carbon rapidly builds up in it. This will increase the frequency with which the engine needs to be serviced. All data on fluid levels and running hours should be recorded in a logbook. Every day, the outside of the engine must be cleaned and, in dusty conditions, the air filter must be checked and cleaned. In moderately dusty conditions, oil-bath air filters are cleaned once a week, dry-paper air filters a little less frequently. If the engine is connected to a pump or generator with a v-belt, the belt will need to be replaced regularly. Once a year, the engine house must be painted and repaired.

The engine is serviced for preventive maintenance according to the number of hours it has run. Every 50 hours, the clutch (if present) must be greased. Every 250 hours, the filters must be cleaned or replaced, the oil changed, and the nuts, bolts and exhaust pipe checked. Every 1500 hours, a major service overhaul will be needed, that includes decarbonising the engine, adjusting the valve clearance, etc. Diesel engines require a lot of simple maintenance and if this is done well, they can have a long service life. Therefore, the training and supervision of the caretaker are important. More complicated maintenance tasks and repairs have to be done by a well-trained mechanic with access to spare parts. The organizing committee must make sure that generator servicing is carried out on schedule, and that they can respond quickly in case the generator breaks down.

5.4.3 Actors and their roles

Actors	Roles	Skills required
Caretaker.	Operate the engine, keep a logbook, perform minor servicing, warn in case of irregularities.	✖✖✖
Water committee.	Supervise the caretaker, collect fees, organize major services and repairs.	✖
Area mechanic.	Perform major services and repairs.	✖✖✖
External support.	Train the caretaker and area mechanics.	✖✖✖✖

✖ Basic skills. ✖✖ Technical skills. ✖✖✖ Highly qualified.

5.4.4 O&M technical requirements

Activity and frequency	Materials and spare parts	Tools and equipment
Daily		
— check fluid levels, and top-up if necessary;	Fuel, engine oil, cooling liquid.	Funnels, containers for liquids.
— start and stop the engine;		
— keep a logbook.	Paper, pen.	
Weekly		
— check the air filter, and clean or replace it if necessary;	New, dry paper filter, kerosene and engine oil.	Wrench.
— check for oil and fuel leaks;		
— tighten any loose nuts and bolts.		Spanners.
Every 250 hours		
— change engine oil.	Engine oil.	Spanners.
Regularly		
— clean or replace filters;	Oil filter, fuel filter.	Spanners, special tools.
— replace the drive belt.	Drive belt.	Spanners.
Every 500–2000 hours		
— decarbonize the engine, clean injector nozzles, adjust valves, etc.		Spanners, brass wire brush, special tools
Occasionally		
— replace engine parts;	Nozzles, injectors, gaskets, bearings, fuel pump, etc.	Depends on the part to be replaced.
— repair the engine mounting and housing.	Cement, sand, gravel, nuts and bolts, nails, galvanized corrugated iron sheets, wood, etc.	Trowel, bucket, hammer, chisel, saw, spanners, etc.

5.4.5 Possible problems

- the generator wears excessively, because O&M is poorly carried out, or neglected;
- the engine is run at less than full loading, which leads to rapid carbon build-up and low engine operating efficiency;
- the drive belts break;
- maintenance is required frequently;
- fuel is difficult to get and its cost is high;
- from time to time, a specialist mechanic will be needed to service and repair the generator.

6. Water treatment

6.1 Introduction

Water can be contaminated by the following agents:

- *Pathogens* – disease-causing organisms that include bacteria, amoebas and viruses, as well as the eggs and larvae of parasitic worms.
- *Harmful chemicals* from human activities (industrial wastes, pesticides, fertilizers).
- *Chemicals and minerals from the natural environment*, such as arsenic, common salt and fluorides. Some non-harmful contaminants may influence the taste, smell, colour or temperature of water, and make it unacceptable to the community.

Water from surface sources is often contaminated by microbes, whereas groundwater is normally safer, but even groundwater can be contaminated by harmful chemicals from human activities or from the natural environment. Rainwater captured by a rooftop harvesting system or with small catchment dams is relatively safe, provided that the first water is allowed to flow to waste when the rainy season starts. The amount of water to be treated should also be assessed. This can be estimated by assuming that each person will need a minimum of 20–50 litres of water a day for drinking, cooking, laundry and personal hygiene.

A community should be consulted when choosing a water-treatment system and should be made aware of the costs associated with the technology. In particular, community members should be made aware of the behavioural and/or cultural changes needed to make the system effective over the long-term and thus be acceptable to them. Communities may also need to be educated about protecting water sources from animal or human contamination, and mobilized. It should be emphasized that all the positive effects of a water-treatment system could be jeopardized if the water is not drawn, stored and transported carefully and hygienically.

The Fact Sheets in this section deal with both community and household methods for treating water. Some household treatment methods and their effectiveness are summarized in Table 6.1, whereas the following household and community water-treatment technologies are described in greater detail:

Household water-treatment systems

- boiling;
- household slow sand filter;
- domestic chlorination.

Community water-treatment systems

- storage and sedimentation;
- up-flow roughing filter;
- slow sand filtration;
- chlorination in piped water-supply systems.

TABLE 6.1 HOUSEHOLD WATER-TREATMENT SYSTEMS AND THEIR EFFECTIVENESS^a

Treatment system	Effectiveness over factors that affect water quality									
	Bacteria, amoebas	Guinea-worm	Cercaria	Fe, Mn	Fluoride	Arsenic	Salts	Odour, taste	Organic matter	Turbidity
Straining through fine cloth Consists in pouring raw water through a piece of fine, clean, cotton cloth to remove some of the suspended solids.	— ^b	☺☺☺	—	—	—	—	—	—	☺	☺
Aeration Oxidizes iron (Fe) and manganese (Mn). Good aeration of the water is also important for slow, sand filtration to be effective, especially if there is not enough oxygen in the surface water. Water can easily be aerated by shaking it in a vessel, or by allowing it to trickle through perforated trays containing small stones.	—	—	—	☺☺☺	—	—	—	☺☺	☺	—
Storage/pre-settlement Storing water for only one day can eliminate some bacteria, but it should be stored for 48 hours to eliminate cercaria (snail larvae). The longer the water is stored, the more the suspended solids and pathogens will settle to the bottom of the container. The top water can then be used after sedimentation.	☺	—	☺☺☺	☺	—	—	—	☺	☺	☺☺
Coagulation, flocculation and settlement In coagulation, a liquid coagulant, such as aluminium sulfate, is added to the water to attract suspended particles. The water is then gently stirred to allow the particles to come together and form larger particles (flocculation), which can then be removed by sedimentation, settlement or filtration. The amount of coagulant needed will depend on the nature of the contaminating chemical compounds and solids.	☺	—	☺	☺	☺☺☺	☺☺☺	—	☺	☺	☺☺
Slow sand filtration Water passes slowly downwards through a bed of fine sand at a steady rate. The water should not be too turbid, otherwise the filter will get clogged. Pathogens are naturally removed in the top layer where a biological film builds up. A potential problem is that some households do not use this technology effectively and the water can remain contaminated.	☺☺☺☺	☺☺☺☺	☺☺☺☺	☺☺	—	☺☺	—	☺☺	☺	☺☺☺☺

^a Adapted from: Skinner & Shaw (1998).^b The treatments were categorized as being: of no effect, or of unknown effectiveness (—); of little effect (☺); moderately effective (☺☺); highly effective (☺☺☺).

TABLE 6.1 CONTINUED

Treatment system	Effectiveness over factors that affect water quality									
	Bacteria, amoebas	Guinea-worm	Cercaria	Fe, Mn	Fluoride	Arsenic	Salts	Odour, taste	Organic matter	Turbidity
<p>Rapid sand filtration The sand used is coarser than in slow sand filtration and the flow rate is higher. The method is used to remove suspended solids and is effective after the water has been cleared with coagulation/flocculation. There is no build-up of biological film, hence the water will still need to be disinfected. It is easier to remove trapped debris from upflow sand filters, compared to filters in which the water flows downwards.</p>	☺	☺☺	☺	☺☺	—	—	—	☺	☺	☺☺
<p>Charcoal filter Granular charcoal (or granulated activated carbon) can be used in filtration and is effective in improving the taste, odour and colour of the water. However, it should be replaced regularly, because bacteria can breed in it.</p>	—	☺☺	☺☺	☺	—	—	—	☺☺☺	—	☺
<p>Ceramic filter The filter is a porous, unglazed ceramic cylinder and impurities are deposited on its surface. Filters with very small pores can remove most pathogens. Open, porous ceramic jars can also be used. The ceramic filter method can only be used with fairly clear water.</p>	☺☺☺	☺☺☺	☺☺☺	—	—	—	—	☺☺	☺☺	☺☺☺
<p>Solar disinfection Ultraviolet radiation from the sun will destroy most pathogens, and increasing the temperature of the water enhances the effectiveness of the radiation. In tropical areas, most pathogens can be killed by exposing the contaminated water to sun for five hours, centred around midday. An easy way to do this, is to expose (half-blackened) clear glass/plastic bottles of water to the sun. Shaking the bottle before irradiation increases the effectiveness of the treatment. The water must be clear for this treatment to be effective.</p>	☺☺☺	☺☺	☺☺	—	—	—	—	—	—	—

TABLE 6.1 CONTINUED

Treatment system	Effectiveness over factors that affect water quality									
	Bacteria, amoebas	Guinea-worm	Cercaria	Fe, Mn	Fluoride	Arsenic	Salts	Odour, taste	Organic matter	Turbidity
Chemical disinfection Chlorination is the most widely used method of disinfecting drinking-water. Liquids (such as bleach), powders (such as bleaching powder), and purpose-made tablets can be used. Iodine can also be used as a chemical disinfectant. Deciding on the right amount of chlorine to use can be difficult, because the effectiveness of chlorination depends on the quality of the untreated water, which may vary according to the season.	☺☺☺	—	☺☺☺	—	—	—	—	☺	☺☺☺	—
Boiling Bringing the water to a rolling boil will kill most pathogens, and many are killed at lower temperatures (e.g. 70 °C). This approach can be expensive, however, because fuel/charcoal is needed to boil the water.	☺☺☺	☺☺☺	☺☺☺	—	—	—	—	☺	☺	—
Desalination/evaporation Desalination by distillation produces water without chemical salts and the method can be used at household level. The method can be expensive because of the capital investment needed and because fuel/charcoal is used to heat the water. The volume of water produced is also low.	☺☺☺	☺☺☺	☺☺☺	☺☺☺	☺☺☺	☺☺☺	☺☺☺	☺☺☺	☺☺☺	☺☺☺

6.1.1 Should water be chlorinated?¹

The water-treatment methods described above can reduce the number of pathogens in water, but do not always eliminate them completely. And although boiling and solar disinfection are effective, the methods are impractical with large volumes of water. In contrast, chemical disinfection inactivates pathogenic organisms and the method can be used with large volumes of water. Chlorine compounds usually destroy pathogens after 30 minutes of contact time, and free residual chlorine (0.2–0.5 mg per litre of treated water) can be maintained in the water supply to provide ongoing disinfection. Several chlorine compounds, such as sodium hypochlorite and calcium hypochlorite, can be used domestically, but the active chlorine concentrations of such sources can be different and this should be taken into account when calculating the amount of chlorine to add to the water. The amount of chlorine that will be needed to kill the pathogens will be affected by the quality of the untreated water and by the strength of the chlorine compound used. If the water is excessively turbid, it should be filtered or allowed to settle before chlorinating it.

¹ From Parr, Smith & Shaw (1995).

6.1.2 Reducing the concentration of chemicals in water

Iron and manganese

Water collected from boreholes can have a high concentration of iron (greater than 0.3 mg/l, the WHO guideline value). This can be the result of a naturally high iron content in the soil, or the result of corrosion (from iron pipes, borehole casings and screens). The iron gives the water an unpleasant metallic taste and odour, stains laundry and white enamel on sinks and bowls, and discolours food. Although such levels of iron are not known to be harmful, the undesirable properties can cause communities to accept contaminated water that has no taste, instead of safe water that has a metallic taste. Most of the iron can be removed simply, by aerating the water and filtering it through sand and gravel. The sand and gravel used in the filters will need to be cleaned periodically.

Similar problems arise when water has excessive manganese concentrations (above 0.1 mg/l, the WHO guideline value), but again the water can be treated by aeration, followed by filtration and settlement.

Fluoride

High concentrations of fluoride (above 1.5 mg/l, the WHO guideline value) can damage bones and teeth. Low-cost treatment methods include the Nalgonda system (which uses lime to soften the water), and using alum as a coagulant. With either treatment, the water is then left to settle at the same time it is being chlorinated.

Arsenic

Arsenic is widely distributed throughout the Earth's crust and enters water as dissolved minerals. It can also enter water bodies in industrial effluents, or by deposition from the atmosphere. Arsenic concentrations greater than the WHO guideline value of 0.01 mg/l are toxic. Simple treatment methods include adding lime to soften the water, or adding alum as a coagulant, followed by settlement. When arsenic (or fluoride) is to be removed at household level, the implementation should always be carefully planned and supported by the community.

6.1.3 Solar disinfection¹

The principle underlying solar disinfection is that microorganisms are vulnerable to light and heat. One easy and simple way to treat water is to use the SODIS system (SOLar DISinfection), which has been tested both in the laboratory and in the field. A transparent container is filled with water and exposed to full sunlight for several hours. As soon as the water temperature reaches 50 °C, the inactivation process is accelerated and usually leads to complete bacteriological disinfection. More information on this method can be obtained from the Swiss Federal Institute for Environmental Science and Technology (EAWAG).

6.2 Boiling²

6.2.1 The technology

Heating water is an effective way to kill the microorganisms in it. WHO recommends that the water be brought to a vigorous boil. This will kill, or inactivate, most organisms that cause diarrhoea. High turbidity does not affect disinfection by boiling, but if the water is to be filtered, this must be done before boiling. For household use, water is mostly boiled in a pot on a stove. If it is not to be stored in the same pot in which it was boiled, the water

¹ From Wegelin & Sommer (1998).

² Gilman & Skillicorn (1985).

should be poured into a clean storage container immediately after boiling, so that the heat of the boiled water will kill most of the bacteria in the storage container. Fuel costs, and the time involved in boiling and cooling the water, limit the usefulness of this method. A study in Bangladesh estimated it would cost 7% of the average family budget to boil all the water for the village (Gilman & Skillicorn, 1985). Also, fuel prices continue to rise in most parts of the world.

6.2.2 Main O&M activities

Disinfection of water by heating is normally carried out within the household. Usually, the water is brought to a rolling

boil in a clean pot on a stove, sometimes with herbs added to the water. The water is then allowed to cool down. Care must be taken not to contaminate the water after boiling.

When fuel has to be collected or treated, this may take up a lot of a household's time. In the kitchen, everyday maintenance includes checking the stove and pots. The frequency with which the stove will need to be repaired or replaced will depend on stove design, the quality of materials and workmanship, and intensity of use. Pots are seldom repaired, and earthen pots often need to be replaced. The necessary skills for O&M activities are usually available in all communities.

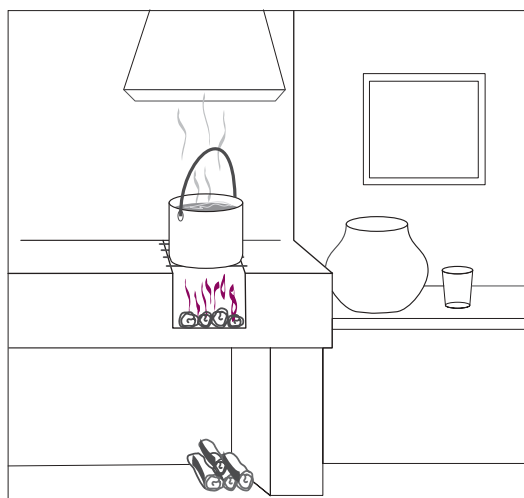

Figure 6.2 Boiling of water

6.2.3 Actors and their roles

Actors	Roles	Skills required
Household member.	Collect fuel and water, boil water, clean utensils, monitor boiled water supply, repair mud stove.	😊
Blacksmith.	Repair metal stove.	⚡⚡

😊 Simple (often requires gender-specific awareness-raising, and training activities to change behaviour and build capacity);
⚡⚡ Technical skills.

6.2.4 O&M technical requirements

Activity and frequency	Materials and spare parts	Tools and equipment
Daily		
— collect fuel;	Wood, charcoal, kerosene, cattle dung.	Rope, can, bag.
— boil the water;	Water, fuel.	Stove, pot.
— clean the containers;	Water, sand, ashes, soap.	Cloth, brush.
— clean the stove.	Water, sand, ashes, soap.	Cloth, brush.
Occasionally		
— repair the stove.	Mud, stones, metal.	Pliers, hammer, steel saw, welder.

6.2.5 Potential problems

- the water becomes recontaminated after boiling;
- fuel for boiling the water is scarce and, consequently, expensive;
- boiled water tastes flat – this may be corrected by adding herbs to the water during boiling and not drinking it for six hours after it has been boiled.

6.3 Household slow sand filter¹

6.3.1 The technology

With a household slow sand filter, water is passed slowly downwards through a bed of sand, where it is treated by a combination of biological, physical and chemical processes. Fine particles in the water are filtered out by the sand, while microorganisms grow on top of the sand filter and feed on bacteria, viruses and organic matter in the water.

The filter can be made of clean 200-litre steel barrels connected by hoses. The system consists of a raw-water supply tank, a filter tank and a clean water tank. A floating weir (that can be made of a bowl, two small tubes and a hose) in the supply tank maintains a constant flow of water to the top of the filter tank, where it is purified by passing downwards through a 45–60-cm bed of washed sand and a 5-cm layer of fine gravel. The water flows through the sand at about 0.1 m/hour ($1 \text{ m}^3 \text{ m}^{-2} \text{ h}^{-1}$). Water drains from the bottom layer of the filter tank via a perforated tube and is led to a clean water-storage tank. To prevent oxidation of the steel barrels, they must be treated with cement mortar, or any safe protective paint. Instead of steel barrels, tanks of ferrocement and other materials can also be used. All tanks should be protected with lids.

With good operation and maintenance, a household slow sand filter produces water virtually free from disease-causing organisms.

Initial cost: This depends on the local cost of used metal drums and other parts.

Yield: 380 litres per day for a tank 0.45 m in diameter.

Area of use: In places where drinking-water is unsafe and needs to be purified at household level.

Manufacturers: Local artisans can make a household slow sand filter.

6.3.2 Main O&M activities

For a slow sand filter to be effective, the flow of water must be maintained at a constant 0.1 m/h. This provides the organisms in the filter with a stable flow of nutrients and oxygen, and gives them time to purify the water. The flow rate of the water is regulated by adjusting the floating weir. The raw-water storage tank must never be allowed to empty.

After a few weeks of operation, (or a few months, depending on the quality of the raw-water), the flow rate in the filter will become too low. At this point, 1–2 cm of sand and

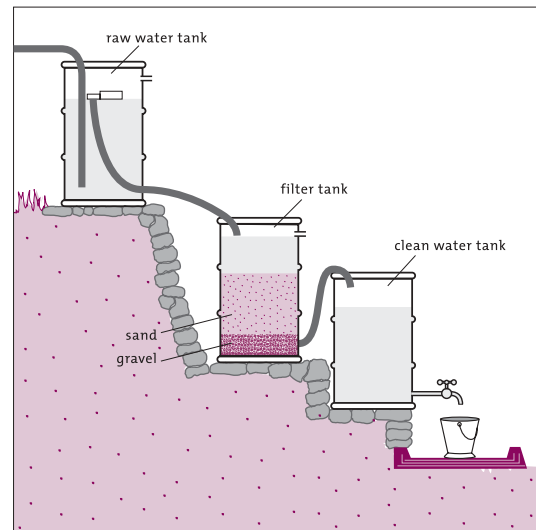

Figure 6.3 Household flows and filter

¹ USAID (1982).

organic material must be scraped off the top of the filter, washed, dried in the sun and put aside. When the filter bed becomes too thin, the washed sand is restored. This is done by taking some more sand from the top of the filter, adding back the washed sand from previous operations, and then placing the sand just taken out on top of the filter. Every year, the tanks must be checked for corrosion, and any leaks repaired immediately. Occasionally, the clean-water tank may need to be disinfected with chlorine, and a hose or tap may need to be repaired. As a household slow sand filter is operated at family or household level, the organizational structure for operation already exists. At least one person in each household should be trained in matters of hygiene, and in the O&M of the filtering system. It may also be beneficial to have a local laboratory to support and train families on water-quality issues.

6.3.3 Actors and their roles

Actors	Roles	Skills required
Family member.	Use water, fill raw-water tank, regulate flow, change sand filter, perform small repairs.	☺
Local artisan.	Construct system, repair taps and leaks.	✂✂
External support.	Train family members, check water quality.	✂✂✂

☺ Simple (often requires gender-specific awareness-raising, and training activities to change behaviour and build capacity);
 ✂✂ Technical skills. ✂✂✂ Highly qualified.

6.3.4 O&M technical requirements

Activity and frequency	Materials and spare parts	Tools and equipment
Daily		
— fill raw-water reservoir;	Raw water.	Bucket.
— check flow rate.	Watch.	
About every six weeks		
— scrape off sand from top of filter, wash, dry and store it.	Water.	Scraper, bucket.
Occasionally		
— repair tap;	Washer, spare tap.	Screwdriver, spanners.
— disinfect clean water tank.	Chlorine.	Bowl, spoon.
Yearly or less		
— restore sand.	Water, clean recycled and new sand.	Bucket, sieve.
Every two years		
— replace hoses.	Hose.	Knife.

6.3.5 Potential problems

- water quality drops if the flow rate through the filter is too high;
- if the water flow is interrupted for more than a few hours, or if the surface of the filter runs dry, beneficial microorganisms in the filter may die and the effectiveness of the filter may be impaired;
- excessive turbidity (>30 NTU) in the raw water can cause the filter to clog rapidly, in which case a pre-filter may be needed;

- when water quality is very poor, harmful and bad-tasting products like ammonia may be formed in the lower layers of the filter;
- smooth vertical surfaces in the filter tank may cause short circuits in the water flow, producing badly-filtered water;
- in some regions, sand is expensive or difficult to get – as an alternative, other materials such as burnt rice husks can be used;
- household slow sand filters require a substantial investment and dedicated O&M, and can thus be expensive.

6.4 Water chlorination at household level¹

6.4.1 The technology

Chlorination of water at household level can be used as an emergency measure or as part of everyday life. When water quality cannot be trusted, a carefully measured amount of concentrated chlorine solution is added to a container with a known amount of clear water. The mixture is stirred and left for at least 30 minutes, to let the chlorine react and oxidize any organic matter in the water. After this, the water is safe to drink. The amount of chlorine needed depends mainly on the concentration of organic matter in the water and has to be determined for each situation. After 30 minutes, the residual concentration of active chlorine in the water should be between 0.2–0.5 mg/l, which can be determined using a special test kit. The concentrated chlorine solution can be made of clear water and chlorine-producing chemicals, such as bleaching powder, sodium hypochlorite, or organic chlorine tablets. It can be prepared at household level, but also in larger quantities and distributed among the households. A concentrated chlorine solution should be used within a relatively short time (defined according to the compound used) before it loses its strength. In some cases, chlorine-producing chemicals are added directly added to the water, without prior dilution. Some chlorine products come in combination with a flocculant to help settle suspended material in the water.

Initial cost: The costs depend on the type of chlorine compound used, the quality of the untreated water, etc.

Yield: About 150–1400 m³ treated water per kg of dry chemical, depending on the water quality and the strength of the concentrated chemical.

Area of use: Wherever drinking-water needs to be disinfected at household level, and chlorine is available.

Trademarks: Chlor-dechlor; Dazzle; Halamid; Halazone; Javelle; Milton; Regina; Zonite and many others.

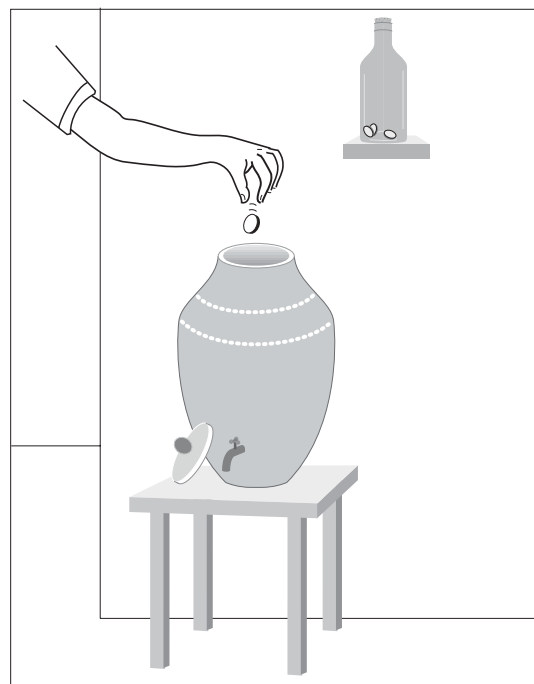

Figure 6.4 Domestic chlorination using a chlorine tablet

¹ White (1986)

6.4.2 Main O&M activities

In some cases, the water will need to be pre-treated (e.g. by filtering), to remove particulate matter. Chlorine-producing chemicals should be stored in a cool, dry place, and care should be taken not to get any of the chemicals in the eyes or on clothes. Disinfection with chlorine can easily be learned and needs to be done regularly. Apart from cleaning and occasional replacement of containers and utensils, no maintenance is needed. If the concentrated chlorine solution or chlorine-producing chemicals are provided by an external organization, there will be logistical and administrative problems, and training to deal with. Sometimes communities organize the buying of chemicals themselves, but even then some training at household level will be useful.

6.4.3 Actors and their roles

Actors	Roles	Skills required
Household member.	Disinfect the water, clean the containers and utensils.	☺
Local health worker.	Prepare concentrated chlorine solution, or provide the chlorine chemical itself.	✳
Local shopkeeper.	Sell chlorine chemical.	☺
External support.	Determine doses, train water users.	✳✳✳

☺ Simple (often requires gender-specific awareness-raising, and training activities to change behaviour and build capacity);
✳ Basic skills. ✳✳✳ Highly qualified.

6.4.4 O&M technical requirements

Activity and frequency	Materials and spare parts	Tools and equipment
Daily		
— treat the water with chlorine.	Concentrated chlorine solution, clear water.	Water container, measuring cup, stirring rod.
Weekly		
— prepare concentrated chlorine solution;	Hypochlorite, chlorinated lime, etc., clear water.	Bottle, spoon, scale.
— clean containers and utensils.	Clean water, soap.	Brush or cloth.
Occasionally		
— recalculate the proper chlorine dose.	Water sample, test media.	Test kit.

6.4.5 Potential problems

- if the water quality varies over time, the required dose of chlorine has to be recalculated;
- if they are not stored properly, chlorine-producing chemicals lose their strength quickly – even when stored under the best conditions, bleaching powder loses half of its strength in about a year;
- chlorine-producing chemicals and test media are often not readily available.

6.5 Storage and sedimentation¹

6.5.1 The technology

The quality of raw water can be improved considerably by storage. During storage, non-colloidal, suspended particles slowly settle to the bottom of a storage tank, and solar radiation will kill some of the harmful organisms in the water. *Schistosoma* larvae, for example, will die after storage for at least 48 hours. In contrast, colloidal particles remain in suspension. The smaller the suspended particles, the longer the water needs to be retained in the reservoir. If the suspended matter precipitates very slowly, chemicals can be added to induce coagulation and flocculation. The reservoir can be constructed in several ways:

- below ground level, with a lining of plastic sheeting to separate the stored water from the ground;
- with a lining of loam, clay or concrete;
- entirely from brick or concrete.

Reservoirs for sedimentation usually have two separate sections. While one is in use, the other can be cleaned. They have an intake on one side of the reservoir (or at the bottom), an outlet on the opposite side just beneath the water level, and a bottom outlet to flush the deposited material.

When the water quantity or quality at the source is temporarily low, a large storage reservoir can also provide an alternative temporary source of water.

Initial cost: Depends on the type of construction.

Range of depth: Usually, 0.7–2.0 m.

Treatment time: A few hours to several days.

Area of use: Wherever raw water contains high concentrations of suspended solids, or where the quality or quantity of the water at the source varies considerably.

6.5.2 Main O&M activities

Usually, water will be let in to the storage reservoir every day or continuously, but when the water quality becomes too poor and there is sufficient water stored in the reservoir, the water intake may be stopped temporarily. The reservoir will have to be flushed regularly to remove the deposited silt – the frequency for this will depend on the silt content of the water and the reservoir depth. All valves in the system must be opened and closed at least once every two months to keep them from becoming stuck. Occasionally, the valves may need to be repaired or replaced, and leaks in the reservoir will have to be fixed. Apart from some help from the water users to clean the reservoir after it has been flushed, the system requires little support from an established organization to maintain it.

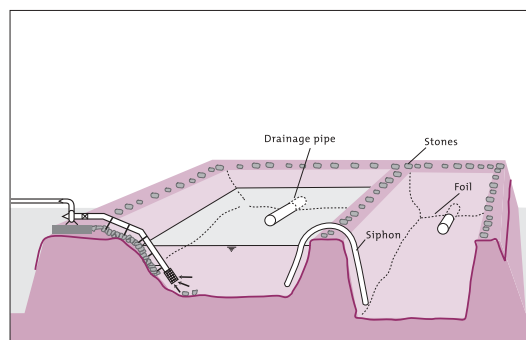

Figure 6.5 Storage and sedimentation

¹ Water Research Centre and WHO Regional Office for Europe (1989).

6.5.3 Actors and their roles

Actors	Roles	Skills required
Caretaker.	Regulate the water flow, flush the reservoir, perform small repairs.	✘
Water committee.	Supervise the caretaker.	✘
Water user.	Assist in cleaning the reservoir.	😊
Local or area mason.	Repair leaks in the brickwork or concrete.	✘✘
Local or area mechanic.	Repair the valve.	✘✘

😊 Simple (often requires gender-specific awareness-raising, and training activities to change behaviour and build capacity);

✘ Basic skills. ✘✘ Technical skills.

6.5.4 O&M technical requirements

Activity and frequency	Materials and spare parts	Tools and equipment
Daily		
— regulate the inlet.		
Regularly		
— flush deposited silt.		Broom, spade, bucket.
Every two months		
— open and close the valves.		
Occasionally		
— repair the valves;	Washers, nuts and bolts, spare valve.	Spanners, screwdriver, wrench, pipe threader, etc.
— repair leaks.	Plastic, clay, cement, sand, etc.	Spade, hoe, chisel, hammer, bucket, trowel, etc.

6.5.5 Potential problems

- leaks, which should be repaired immediately;
- if the solids in the water do not settle quickly enough, coagulation and flocculation may be needed.

6.6 Upflow roughing filter¹

6.6.1 The technology

Roughing filters are often used to pretreat water by removing suspended solids from the water that could rapidly clog a slow sand filter. Roughing filters can also considerably reduce the number of pathogens in the water, as well as the amount of iron and manganese. There are many types of roughing filters with different flow directions (downflow, upflow and horizontal flow filters), and with different types of filter medium (e.g. sand, gravel, coconut husk fibre). Upflow roughing filters are relatively cheap and easier to clean than downflow or horizontal flow filters.

An upflow filter box can be made of bricks, concrete or ferrocement. It can have a round or rectangular shape, with vertical or partially inclined walls, and it is usually about 1.5 m deep. Water flows in through an underdrain system on the bottom, usually a perfo-

¹ Wolters & Visscher (1989); Galvis et al. (1993).

rated PVC pipe, which also permits rapid abstraction during cleaning when the flow direction is reversed (backwashing). For backwashing, a special drainage valve is installed which can be opened quickly.

The underdrains are covered with a layer of coarse gravel, on top of which lie several layers of finer gravel and coarse sand. The filter layers are covered with a 0.1 m-deep layer of boulders, to avoid exposing the outflow directly to sunlight; this helps to prevent algal growth. The outflow is stored in an outlet structure. In some cases, the outflow of one roughing filter is fed to another roughing filter with finer material for further cleaning.

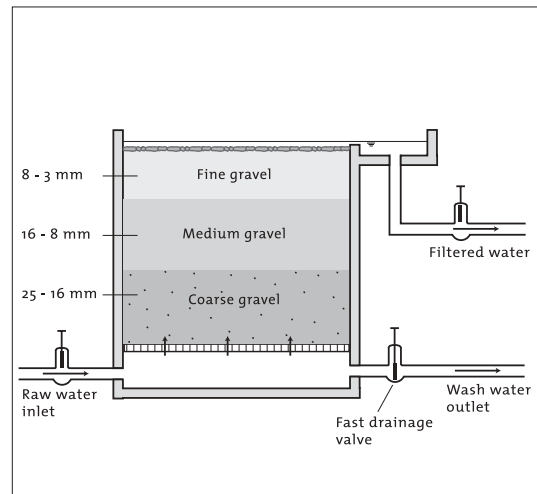

Figure 6.6 Upflow roughing filter

Initial cost: Reported construction costs are US\$ 20–40 per m³ of water per day, for a structure designed to be in operation for 24 hours a day (data from Colombia, 1986; Wolters & Visscher, 1989).

Filtration rate: Approximately 0.6 m/h.

Performance: If raw water with a turbidity below 50 NTU is used as the source for a roughing sand filter, the outflow has a turbidity below 12 NTU. Approximately 84–98% of suspended solids are removed. Better results are obtained with two or three filters in series.

Use: As a pre-treatment stage prior to slow sand filtering or other purification processes.

6.6.2 Main O&M activities

The filters should preferably be operated on a continuous basis. Operation consists of regulating the water flow and checking the turbidity of the effluent. Flow, turbidity and maintenance data are written in a logbook. If the turbidity gets too high, the filter may become clogged. In such cases, the filter should be cleaned about once a month, while leading the effluent to outlet. The inlet and outlet boxes are then cleaned, and backwashing and refilling are done twice. The monthly cleaning is performed by the caretaker and takes about half a day. No special assistance from users is required to clean the filters. Every two months, all valves should be completely opened and closed, to keep them from becoming stuck.

After a year or more (depending on the turbidity of the raw water), hydraulic cleaning alone is no longer adequate, and the different filter layers have to be removed and cleaned, which requires several people. The filter should be cleaned before the turbidity of the raw water reaches a maximum (e.g. before the rainy season starts). Occasionally, the valves need to be repaired or replaced, and if a steel weir is used this may need to be painted or replaced. New caretakers can be trained by experienced technicians.

6.6.3 Actors and their roles

Actors	Roles	Skills required
Caretaker.	Regulate the water flow, keep a logbook of repairs etc., clean the filters hydraulically, organize manual cleaning.	✘
Water committee.	Supervise the caretaker, organize manual cleaning.	✘
Water user or paid worker.	Assist in manual cleaning.	😊
Local or area mechanic or plumber.	Repair or replace valves.	✘✘

😊 Simple (often requires gender-specific awareness-raising, and training activities to change behaviour and build capacity);

✘ Basic skills. ✘✘ Technical skills.

6.6.4 O&M technical requirements

Activity and frequency	Materials and spare parts	Tools and equipment
Daily		
— regulate the water flow;		
— make entries into a logbook.	Logbook, pen.	
Weekly		
— hydraulically clean the filters.	Raw water.	
Monthly		
— stir the top layer of the filter.	Raw water.	Rake, hoe.
Every two months		
— open and close all valves.		
Every two years		
— manually clean and refill the filter.	Raw water.	Spade, bucket, wheelbarrow, sieves, washbasin.
Annually		
— grease the valves;	Grease.	Grease pot, cloth.
— paint the steel parts.	Anticorrosive paint.	Steel brush, paintbrush.
Occasionally		
— repair or replace the valve.	Washers, lids, bolts, nuts, spare valve.	Spanners, wrench, screwdriver, pipe threader, etc.

6.6.5 Potential problems

- high loads of organic and other suspended material in the raw water clog the filter and reduce the hydraulic cleaning capacity;
- roughing filters only remove some of the solids and pathogens in the water, and additional treatment is needed.

6.7 Slow sand filtration¹

6.7.1 The technology

The treatment of water by slow sand filtration combines biological, chemical and physical processes when the water slowly passes downwards through a bed of sand. Fine particles are filtered out, and in the sand and on top of the filter bed a population of microorganisms develops that feed on bacteria, viruses and organic matter in the water. The filter reservoirs have drains on the bottom covered with gravel and sand. Raw water slowly enters the filter through an inlet, and an outlet leads the clean water from the drains to the clean-water mains.

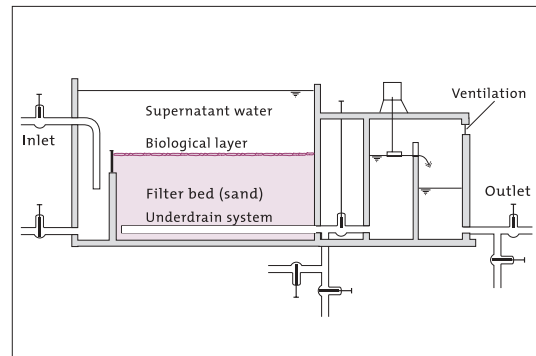

Figure 6.7 Slow sand filter

During operation, the sand filter is covered with a water layer of 0.3–1.0 m. For the filter to work well, water must flow continuously at a rate of 0.1–0.3 m/hour. For community use, filter reservoirs can be made of concrete, bricks, ferrocement, etc. At least two filters are needed if clean water is to be provided continuously.

When the quality of the raw water is poor, it is recommended that pretreatment steps be added (e.g. upflow roughing filter). Sometimes, the water is chlorinated after filtration to prevent recontamination. With good O&M, a slow sand filter produces water virtually free of harmful organisms. For the small-scale application of this method, see section 6.3 *Household slow sand filter*.

Initial cost: Data from rural India in 1983 indicate an initial cost of US\$ 60–130 per m² of filter area. In Colombia, the cost was US\$ 105–215 per m² in 1987.

Yield: 0.1–0.3 m³ m⁻² hour⁻¹.

Area of use: All over the world.

Manufacturers: Slow sand filters can be built by experienced contractors, or by communities with external technical assistance.

6.7.2 Main O&M activities

For a slow sand filter to be effective, it must be operated and maintained properly. The flow of water must be maintained at a rate between 0.1–0.3 m per hour. This provides a stable flow of nutrients and oxygen to the microorganisms in the filter and gives them time to treat the water. After several weeks to a few months, the population of microorganisms may get too dense and start to clog the filter. The flow rate of the water into the sand filter may then have to be adjusted, or the layer of water above the filter will build up and become too high. If flow rates get too low, the filter must be drained and the top layer of the sand scraped off, washed, dried in the sun, and stored. After several scrapings, the cleaned and dried sand is added back to the filter, together with new sand, to make up for losses during washing. Every two months, all the valves must be opened and closed to keep them from becoming stuck, and any leaks in the system must be repaired immediately.

The caretaker of a slow sand filter should keep a logbook with flow rates and O&M activities. Slow sand filters can be operated and even monitored by communities, provided the caretakers are trained well. It takes a caretaker less than one hour a day to check whether the filter is functioning properly and to adjust flow rates, although cleaning the site and other activities may take more time. Several people can clean a filter unit

¹ Visscher et al. (1987); IRC (1993).

in only one day, but it is important that hygienic measures are observed every time someone enters the filter unit for maintenance or inspection work. If the filter is well-designed and constructed, hardly any repairs of the filter tanks and drainage system will be needed, although the valves and metal tubing may need occasional attention. Test kits to monitor water quality are available and they require only basic training to use.

A slow sand filter for community use requires considerable organization to be able to provide enough people for scraping and resanding the filter units. A local caretaker will have to be trained, and others may need to be trained to test the water quality and to be able to stand in for the caretaker. Apart from extra sand, some chlorine and test materials, very few external inputs are needed. With proper external assistance, water organizations can manage their water treatment independently.

6.7.3 Actors and their roles

Actors	Roles	Skills required
Local caretaker.	Regulate flow, keep site clean, lead scraping and re-sanding.	✘
Water user or paid worker.	Assist in scraping and re-sanding of filter units.	☺
Water committee.	Supervise the caretaker, monitor water quality, collect fees, organize scraping and re-sanding.	✘ / ✘ ✘
Local plumber.	Repair valves and piping.	✘ ✘
External support.	Train the caretaker, monitor water quality.	✘ ✘ ✘

☺ Simple (often requires gender-specific awareness-raising, and training activities to change behaviour and build capacity);
✘ Basic skills. ✘ ✘ Technical skills. ✘ ✘ ✘ Highly qualified.

6.7.4 O&M technical requirements

Activity and frequency	Materials and spare parts	Tools and equipment
Daily		
— check the inflow;		
— regulate the flow;		
— keep a logbook;	Logbook, pen.	
— clean the site.		Broom.
About every six weeks		
— scrape off the sand, wash, dry and store.	Water, disinfectant for tools, boots for feet.	Wheelbarrow, hoe, rake, spade, rope, bucket, ladder, planks, broom, wash basin.
About every 18 months		
— re-sand the filter.	Recycled and new sand, water, disinfectant for tools, boots for feet.	Sieve, wheelbarrow, hoe, rake, spade, rope, bucket, ladder, planks.
Occasionally		
— repair the valve;	Washers, spare valve.	Spanners, screwdriver, wrench
— replace the metal tubing;	Nipples and accessories, plumbing sealant or Teflon, cement, sand.	Steel saw, wrench, pipe threader, hammer, chisel, trowel, bucket.
— disinfect the filter outlets.	Chlorine.	Bucket, brush.
Regularly		
— analyse the water quality.	Water sample, test media.	Test kit.

6.7.5 Potential problems

- if the flow rates through the filter are too high, water quality drops;
- excessive turbidity (>30 NTU) in the raw water can cause the filter to clog rapidly, in which case a pre-filtration step may be needed;
- when the water quality is very poor, harmful and bad-tasting products such as ammonia may be formed in the filter;
- it may take some time for people to believe that a green and slimy filter can produce safe water;
- if the water flow is interrupted for more than a few hours, beneficial microorganisms in the filter may die and the filter action will become impaired;
- smooth vertical surfaces in the filter can cause short circuits in the water flow and result in poor-quality water;
- in some regions, sand is expensive or difficult to get;
- slow sand filters require a substantial initial investment, and dedicated O&M;
- it takes a few days for a filter to “ripen” after re-sanding and in this period the water quality is lower.

6.8 Chlorination in piped systems¹

6.8.1 The technology

Chlorination is a chemical method for disinfecting water. The chlorine inactivates pathogens in the water and provides a barrier against recontamination. It is normally applied at the last stage of a drinking-water treatment process. The most frequently used low-cost technology methods are batch chlorination and flow chlorination. For batch chlorination, a concentrated chlorine solution is added to the water in a reservoir, with both inlets and outlets closed. The water is stirred and the chlorine is left to react for at least 30 minutes. After that, the outlets can be opened. When the reservoir is empty, the outlets are closed and the reservoir is refilled with a new batch of water to be disinfected.

Flow chlorinators continuously feed small quantities of a weak chlorine solution to a flow of fresh water, often at the inlet of a clear-water reservoir. Usually, a small reservoir containing the chlorine solution is placed on top of the water reservoir and the solution is administered close to the point where fresh water comes in, and turbulence guarantees good mixing. A special device, such as the floating bowl chlorinator, enables precise dosage. Sometimes a special electric pump is used for this purpose.

Electrical devices that convert a solution of kitchen salt to active chlorine can be purchased for on-site chlorine production. Small test kits are also available for monitoring and for adjusting chlorine doses to the water quality and quantity. Chlorine-producing compounds must always be stored and prepared with care.

Initial cost: A chlorinator and hoses can cost as little as US\$ 15, but there will be addi-

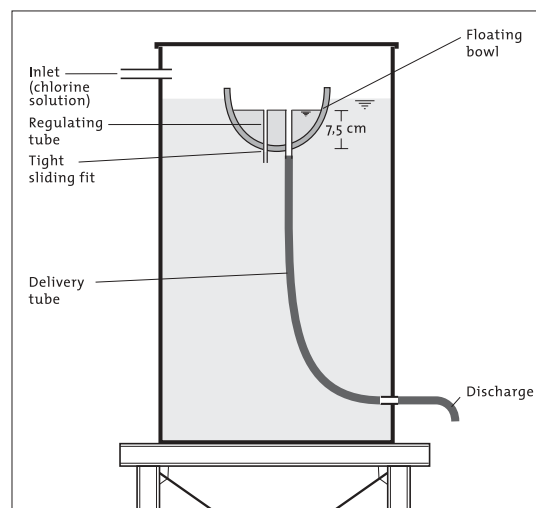

Figure 6.8 Floating bowl chlorinator

¹ Water Research Centre & WHO Regional Office for Europe (1989).

tional costs for the tank, for the concentrated chlorine solution, and for the construction costs of a protective shelter.

Yield: Generally, 350–1400 m³ of treated water per kg of a 70% chlorine compound.

Area of use: Wherever drinking-water needs to be disinfected and chlorine is available.

6.8.2 Main O&M activities

The flow rate of the raw water must be checked and adjusted if necessary, and the chlorine tank must be refilled with a freshly-prepared solution once or twice a week. Operators must be careful to avoid contact with chlorine compounds or solutions, and use protective gloves and utensils to prepare the chlorine solutions. The gloves and utensils will need to be replaced occasionally. In some cases, the amount of chlorine added to the water, together with residual chlorine levels, are recorded in a logbook. Chlorinators must be adjusted and cleaned of chlorine salts regularly, and when the hoses become corroded by chlorine they must be replaced. If a steel chlorine tank is used, it must be painted and checked for corrosion every year, and the shelter for the chlorine tank needs to be maintained. Usually, the water committee appoints a caretaker who is trained for such work. The chlorine compound itself must be obtained from a merchant or the health department, and an adequate supply of chlorine compound must be kept in stock. An external organization, such as a government health or water department, will provide training for caretakers and perform monitoring.

6.8.3 Actors and their roles

Actors	Roles	Skills required
Caretaker.	Refill the chlorine tank and prepare the chlorine solution, clean and adjust the chlorinator, perform small repairs.	✘
Water committee.	Supervise the caretaker, collect fees.	✘
Local health worker, shopkeeper or merchant.	Provide or sell chlorine compounds.	☺
External support.	Check residual chlorine in water and adjust doses, train the caretaker.	✘✘✘

☺ Simple (often requires gender-specific awareness-raising, and training activities to change behaviour and build capacity);
✘ Basic skills. ✘✘✘ Highly qualified.

6.8.4 O&M technical requirements

Activity and frequency	Materials and spare parts	Tools and equipment
Once or twice a week		
— refill the chlorine tank.	Chlorine compound, water.	Spoon, scale, bucket, stirring rod.
Regularly		
— adjust and clean the chlorinator;	Water.	Measuring cup, stopwatch.
— check and adjust chlorine doses.	Test media, water samples.	Test kit.
Occasionally		
— replace the hoses and chlorinator.	Hose, small tubes (plastic, glass, etc.), plug, bowl.	Knife, nail.
Annually		
— paint the steel tank.	Latex paint.	Steel brush, paint brush.

6.8.5 Potential problems

- chlorination is less effective in alkaline water (pH above 8.0);
- when the water contains excessive organic matter or suspended material, it will need to be pretreated;
- the cost and availability of chlorine compounds can be serious limitations;
- chlorination affects the taste of water and for this reason the water may be rejected by consumers who have not been informed;
- on the other hand, users may believe a chlorine taste indicates that the water has been disinfected, but water can still taste of chlorine even when not enough has been added to purify it.

Despite these limitations, disinfecting drinking-water by chlorination is one of the most effective and least-expensive technologies available and should be encouraged.

7. Storage and distribution

7.1 Introduction

The following storage and distribution systems are described in the Fact Sheets:

Storage

- concrete-lined earthen reservoir;
- reinforced concrete reservoir;
- elevated steel reservoir;
- ferrocement tank.

Distribution

- public standpost;
- domestic connection;
- small flow meter.

These lists are not exhaustive, but have been selected as being most relevant to small, community water-supply systems. Of the storage options reviewed, the concrete-lined earthen reservoir is the only system that is suitable for storing raw water, and the O&M of such a system should consider the possibility that a raw water source will be used. A water-lifting method to get the raw water to the storage reservoir may be necessary and this should also be considered in the O&M implications. In many cases, a concrete-lined earthen reservoir can be used instead of open concrete reservoirs.

Flow meters are only discussed in general, and no comparison is made between types and brands, because this is outside the scope of this manual. However, the decision to install flow meters has important operational and organizational implications.

Material selection

The type of material chosen for the pipes and accessories will determine the maintenance activities that will be needed. Both polyvinyl chloride (PVC u) and polyethylene (PE) are used in drinking-water networks, but PE is more commonly used for smaller diameter pipes and with lower water pressures. It comes in rolls that are 50 m or 100 m long and is more flexible than PVC u . PVC u comes as pipes 6 m in length and up to 300 mm in diameter (sometimes more). Commonly, more accessories are available for PVC u than for PE, but PVC u is more easily fractured by poor handling and laying techniques. However, when properly installed, PVC u pipes need hardly any maintenance, except for controlling leaks.

Asbestos cement pipes are made with external diameters from 100 mm to over 1000 mm. They are not suitable for use with high water pressures, but they are relatively cheap. Asbestos cement pipes cannot be installed in aggressive soils, since they are susceptible to corrosion. Because of their rigidity, asbestos cement pipes require careful handling when they are installed, to avoid damaging them.

In areas with high water pressure (above the local standard pressure), pressure-reducing valves should be considered to reduce the amount of water lost to leakage. For water pressures greater than 1.25 Mpa (about 127-m head of water) metal pipes should

be used. Metal pipes should also be used if they are to be laid on the surface and exposed to sunlight. The following are some features of metal piping and accessories:

- metal pipelines are generally sensitive to corrosion;
- galvanized-iron pipes are supplied in diameters of up to 4 inches (100 mm nominal bore), and steel pipes are supplied in larger diameters;
- ductile iron pipes are similar to steel pipes, but they are more resistant to corrosion;
- cast iron has good resistance to corrosion and is used for accessories, such as connectors and valves, but it is hard and breaks more easily than ductile iron.

Galvanization gives some protection against corrosion, but most metal pipes need to have internal and external protection. Examples of internal protective linings are epoxy resin and cement mortar. Bituminous lining should be avoided because of possible health risks. All internal coatings must be carried out during the manufacturing process, but relining or replacing the piping should be part of O&M activities. External protective coating is beneficial when pipes are laid in corrosive soil conditions. Examples of materials used in external coating include zinc oxide, bitumen paint and polythene sleeving. External coating is usually applied during manufacture, but polythene sleeving can be applied when laying the pipe.

7.2 Concrete-lined earthen reservoir¹

7.2.1 The technology

Lined earthen reservoirs can be built in natural depressions, or constructed by excavating and building a dam around the reservoir. If possible, the quantities of excavation and refill are kept nearly identical, to minimize the amount of work. The inner and outer walls of such a reservoir are always sloped, and inlets and outlets are installed during the earthwork. The walls and bottom of the reservoir must be compacted, especially the parts made by refilling. The inside of the reservoir is waterproofed by a lining of concrete, which is usually poured on-site in large slabs. The slab size is limited by the ability of the concrete slab to support its own weight when it is moved into place during construction of the reservoir. Once in place, the slabs are connected by a sealing of waterproof material. More recently, reservoirs have been constructed using a single slab of concrete, using ferrocement technology. Linings can also be made of clay, loam or plastic.

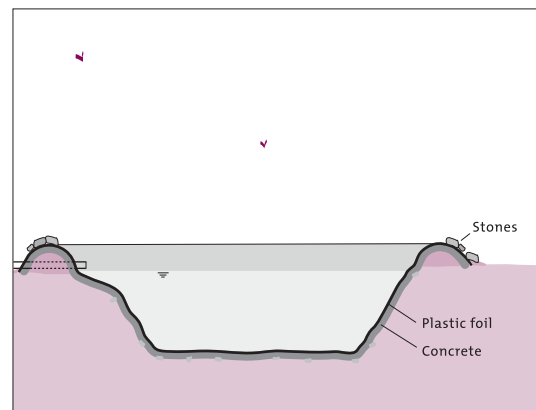

Figure 7.2 Concrete-lined earthen reservoir

Volume of reservoir: From a few cubic metres to many thousands.

Uses: De-silting and storing raw water.

¹ The IFFIC/AIT has good information on ferrocement and related technologies. Contact FFIC/AIT, P.O. Box 2754, Bangkok 10501, Thailand.

7.2.2 Main O&M activities

Operation of a reservoir consists of opening and closing the inlet and outlet valves and sluices, according to water need in the system and water quality at the inlet. The valves and sluices should be opened and closed at least every two months to prevent them sticking. At least once a year, the reservoir should be emptied of sediment and cleaned, and the lining inspected and disinfected with chlorine. Cracks or other damage to the lining should be repaired. Usually, the cleaning of a reservoir is a communal activity, which can be organized by a water committee that coordinates all the activities related to the system. An individual living near the reservoir can be assigned the job of caretaker.

7.2.3 Actors and their roles

Actors	Roles	Skills required
Water user.	Assist in major maintenance and repair activities.	☺
Caretaker.	Open and close the valves, check the water quality at intake, keep a logbook of O&M activities.	✂
Water committee.	Coordinate activities.	✂

☺ Simple (often requires gender-specific awareness-raising, and training activities to change behaviour and build capacity);

✂ Basic skills.

7.2.4 O&M technical requirements

Activity and frequency	Materials and spare parts	Tools and equipment
Daily		
— check the water quality at intake;		
— operate the valves and sluices.		
Occasionally		
— repair the valve;	Washer, spare valve.	Wrench, spanner, screwdriver.
— repair the lining.	Clay, loam, plastic sheeting, cement, sand, gravel, etc.	Wheelbarrow, spade, hoe, chisel, hammer, trowel, bucket, etc.
Annually		
— inspect the lining.		

7.2.5 Potential problems

- the reservoir may rapidly fill with silt;
- cracks may appear in the reservoir lining, which will need to be repaired;
- in regions with prolonged water shortages, the size of the reservoir needed to meet water demand may be too big to be financed by the community.

7.3 Reinforced concrete reservoir¹

7.3.1 The technology

Reinforced concrete reservoirs are used to store clean water for release on demand. They are usually made of concrete reinforced with steel bars or steel mesh, although some low-cost construction techniques use bamboo or other materials to reinforce the concrete. Reservoirs may also be made of masonry, or ferrocement. Chemical additives are often mixed with the concrete to make it more impermeable to water. Reinforced concrete reservoirs are built at the site on a solid foundation. If the base is not solid enough, another site should be chosen, or arrangements made to stabilize the construction.

To protect the water from contamination, the reservoir is covered with a roof, usually made of reinforced concrete, but other materials can be used. In the top of the tank an aeration pipe with a screen allows fresh air to circulate in the tank, but keeps rodents and insects out. A manhole in the roof allows access to the tank for cleaning and repairs. Water flows into the reservoir through an inlet pipe above the water level in the reservoir. This prevents back-flow and allows the water to be heard entering the tank. At this point, a chlorine solution is often added for disinfection. Outlets are built a little above the floor of the reservoir, which has a slope pitched down towards one point with a washout pipe for flushing.

Range of depth: Usually between 1.5–3.0 m.

Expected useful lifetime: 30 years.

Use: For reservoirs larger than about 3 m³ where sand, cement, gravel and reinforcing materials are available.

7.3.2 Main O&M activities

Operation consists of opening and closing the valves, and managing a chlorinator, if provided. If the reservoir does not deliver directly to a tap, water distribution is usually carried out by a caretaker.

A well-designed and well-built reservoir needs very little maintenance. The surroundings must be kept clean on a regular basis; every two months the valves must be closed and opened to prevent them from sticking, and the screens must be checked. Occasionally, a screen or tap may need to be repaired. Once a year, or sooner if contamination is suspected, the reservoir must be drained, de-silted, cleaned with a brush and disinfected with chlorine. Any leaks or cracks in the concrete have to be repaired as soon as possible.

If needed, a caretaker can be appointed to regulate the inflow and outflow. A concrete reservoir has few other organizational requirements.

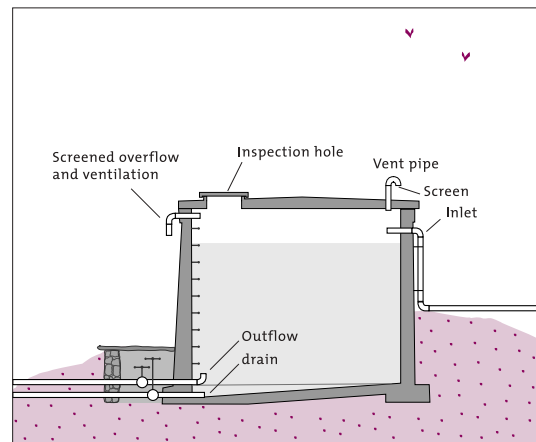

Figure 7.3 Reinforced concrete reservoir

¹ Jordan (1984).

7.3.3 Actors and their roles

Actors	Roles	Skills required
Water user.	Assist in reservoir cleaning.	☺
Caretaker.	Regulate water inflow and outflow, organize cleaning, and warn if repairs are needed.	✘
Water committee.	Supervise the caretaker, organize repairs.	✘
Mason.	Perform repairs.	✘✘
External support.	Check water quality, motivate and guide local organization.	✘✘✘

☺ Simple (often requires gender-specific awareness-raising, and training activities to change behaviour and build capacity);
✘ Basic skills. ✘✘ Technical skills. ✘✘✘ Highly qualified.

7.3.4 O&M technical

Activity and frequency	Materials and spare parts	Tools and equipment
Regularly		
— clean the surrounding area.		Broom, machete, hoe, etc.
At least monthly		
— open and close the valves.		
Occasionally		
— repair the valve;	Washer, spare valve.	Wrench, spanner, screwdriver.
— repair the screen;	Plastic or copper screen, wire.	Pliers, wrench, tin cutter.
— repair the concrete lining.	Cement, sand, gravel, additives.	Trowel, spade, bucket, wheelbarrow, ladder, rope.
Annually		
— clean and disinfect the reservoir.	Chlorine.	Brush, broom, bucket, ladder.

7.3.5 Potential problems

- cracks and leaks form owing to a poor foundation, design or construction;
- exposed metallic components become corroded;
- the water becomes contaminated owing to a poorly-covered manhole or broken screens;
- reinforced concrete is expensive;
- reinforced concrete is also heavy, and the soil beneath the reservoir may settle if the foundation is inadequate.

7.4 Elevated steel reservoir

7.4.1 The technology

An elevated steel reservoir stores clean water in a steel tank on a raised stand or tower. The elevation of the tank provides the water pressure to all points in the pressure zone of the distribution system. Tanks may be cylindrical, rectangular or any other convenient shape. For family use, the tank can be made of an old oil drum (duly coated), and the tower of bamboo. For communal needs, elevated steel tanks are often constructed from factory-made galvanized steel elements bolted or welded together. However, even with galvanization, steel tanks are generally more sensitive to corrosion than concrete reser-

voirs. On the other hand, steel tanks can be built faster and the cost of transporting the material is generally lower, especially when concrete aggregates are not locally produced. Several pipes are connected to the tank, including ones for inlet, outlet, overflow and washout, and a screened vent hole or pipe maintains atmospheric pressure in the tank. There is also an entryway in the cover of the reservoir to allow the reservoir to be inspected. The entryway is normally kept closed with a lid. If an electric pump is used to pump water into the reservoir, the water level in the reservoir can be regulated by sensor electrodes in the tank. Alternatively, a float valve may be used to cut off the inflow when the maximum level has been reached.

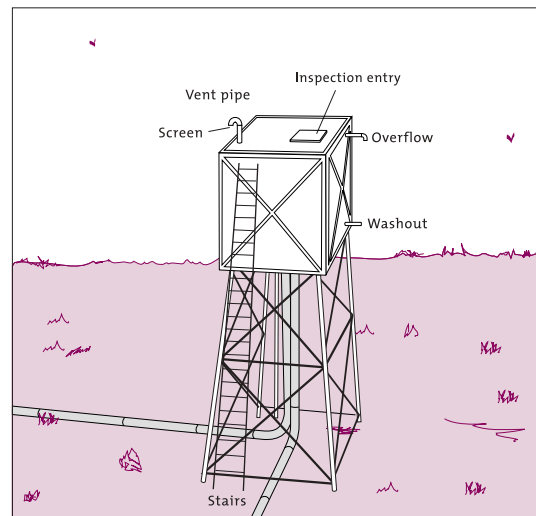

Figure 7.4 Elevated steel reservoir

The tanks may be placed on steel, wooden or reinforced-concrete towers, and special attention must be given to the foundation structure. Big elevated steel tanks are typically used by major water users, such as agricultural enterprises and communities.

Initial cost: Prices vary considerably between countries and tank quality. In 1991, in Tanzania, a circular above-ground tank made of galvanized iron cost US\$ 125 for a 1 m³ tank (US\$ 125 per m³) and US\$ 550 for a 10 m³ tank (US\$ 55 per m³) (Mayo, 1991).

7.4.2 Main O&M activities

Operation consists of opening and closing the valves, and managing a chlorinator if one is used. This is usually done by a caretaker who lives nearby.

For maintenance, the valves must be opened and closed every two months to prevent them from sticking. Some valves need lubricating. The screens must also be checked, and occasionally a screen or valve may need to be repaired. The inside of the reservoir should be cleaned at least every six months and disinfected using a chlorine solution. The tank and the stand should be painted once a year – epoxy-paint coatings should need little maintenance. Any leaks should be repaired immediately.

7.4.3 Actors and their roles

Actors	Roles	Skills required
Caretaker.	Check controlling devices, organize cleaning, and warn if repairs are needed.	✘
Water committee.	Supervise the caretaker.	✘
Welder.	Repair steel parts of the tank.	✘✘
Plumber.	Repair the valves and pipes.	✘✘
External support.	Check the water quality, motivate and guide local organization.	✘✘✘

✘ Basic skills. ✘✘ Technical skills. ✘✘✘ Highly qualified.

7.4.4 O&M technical requirements

Activity and frequency	Materials and spare parts	Tools and equipment
At least monthly		
— open and close the valves;		
Occasionally		
— repair faulty valves;	Washer, spare valve.	Wrench, spanner, screwdriver.
— repair the screen.	Plastic or copper screen, wire.	Pliers, wrench, tin cutter.
Biannually		
— clean and disinfect the reservoir.	Chlorine.	Brush, broom, bucket, ladder.
Annually		
— paint the reservoir.	Anticorrosive paint.	Paintbrush, ladder.

7.4.5 Potential problems

- the reservoir may become corroded and leak;
- steel reservoirs normally require cathodic protection;
- steel reservoirs need relatively more maintenance than those made of concrete, ferrocement or even wood.

7.5 Ferrocement tank¹

7.5.1 The technology

Ferrocement water tanks are made of steel mesh and wire, covered on the inside and outside with a thin layer of cement-and-sand mortar. The walls may be as thin as 2.5 cm. The tanks can be used for individual households or for whole communities, and they provide a relatively inexpensive and easy-to-maintain storage method. To avoid bending forces in the material, most ferrocement tanks have curved walls, in the form of a cylinder, a globe or an egg. Compared to concrete reservoirs, ferrocement tanks are relatively light and flexible. To protect the water from contamination, the tank is covered with a lid or a roof that can be made of various materials, but is usually ferrocement. In this case, an aeration pipe with a screen is needed to allow fresh air to circulate in the tank, while keeping out rodents and insects. A manhole in the roof gives access to the tank for cleaning and repairs. Water flows into the reservoir through an inlet pipe, which is normally above the water level.

Often, a chlorine solution is added to the stored water for disinfection. Outlets are built a little above the floor of the reservoir, which slopes down towards a washout pipe for flushing into a drain. The site is fenced, to keep out cattle that can damage the thin walls of the reservoir.

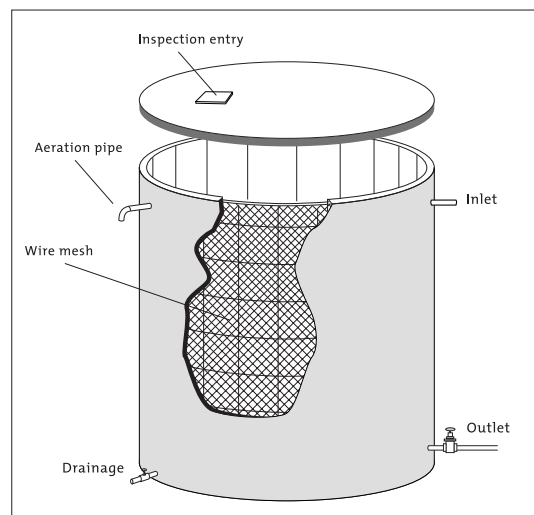

Figure 7.5 Ferrocement tank

¹ Hasse (1989).

Initial cost: In Kenya in 1993, a 20 m³ tank with a roof cost US\$ 420 (US\$ 21 per m³; Cumberlege & Kiongo, 1994). In the South Pacific Islands in 1994, 5.5–12 m³ tanks cost an average of US\$ 50 per m³ (Skoda & Reynolds, 1994).

Range of volume: From 1 m³ to over 80 m³.

Range of depth: Usually, between 1.5–3.0 m.

Area of use: Anywhere that inexpensive storage is needed.

Manufacturers: Ferrocement tanks are built on-site by many organizations, craftsmen and building contractors, and can even be factory made.

7.5.2 Main O&M activities

Operation consists of opening and closing the valves, and managing a chlorinator, if provided. A ferrocement tank that is well-designed and well-built needs very little maintenance. The surroundings, including the drain, must be kept clean on a regular basis; every two months, the valves must be opened and closed to prevent them sticking, and the screens must be checked. Occasionally the fence, a screen or tap may need repair. Every six months, or when contamination is suspected, the reservoir must be drained, de-silted, cleaned with a brush, and disinfected with chlorine. Any leaks have to be repaired immediately. Repair involves some special techniques using wire and mesh, cement, sand and water, but they are easy to learn.

Ferrocement tanks can be used at the family or communal level. If used by communities, a caretaker can be appointed, preferably someone who lives close to the reservoir.

7.5.3 Actors and their roles

Actors	Roles	Skills required
Caretaker.	Clean the reservoir and its surroundings, open and close taps and valves.	✘
Water committee.	Supervise the caretaker, organize repairs.	✘
Mason.	Repair the ferrocement.	✘✘
External support.	Check water quality, motivate and guide local organization.	✘✘✘

✘ Basic skills. ✘✘ Technical skills. ✘✘✘ Highly qualified.

7.5.4 O&M technical requirements

Activity and frequency	Materials and spare parts	Tools and equipment
Regularly		
— clean the surroundings.		Broom, machete, hoe, etc.
At least monthly		
— open and close the valves.		
Occasionally		
— repair the valve;	Washer, spare valve.	Wrench, spanner, screwdriver.
— repair the screen;	Plastic or copper screen, wire.	Pliers, wrench, tin cutter.
— repair the ferrocement.	Wire, mesh, cement, sand, additives.	Chisel, hammer, steel brush, trowel, spade, bucket, pliers.
Biannually		
— clean and disinfect the reservoir.	Chlorine.	Brush, broom, bucket.

7.5.5 Potential problems

- cracks and leaks appear, owing to poor design and construction;
- the water becomes contaminated, owing to a poorly-fitted cover, unsafe form of water abstraction, or broken screens;
- exposed metallic parts become corroded;
- ferrocement is less suitable for rectangular structures;
- in regions without ferrocement technology, it may take time for the community to accept the different concept of construction – generally, people do not trust the thin walls and think they include too much steel.

7.6 Public standpost¹

7.6.1 The technology

A public standpost or tapstand distributes water from one or more taps to many users. Because it is used by many people it is often not looked after, and the design and construction must be sturdier than used in similar domestic connections. A standpost includes a service connection to the supplying water pipeline, a supporting column or wall made of wood, brick, dry stone masonry, concrete, etc, and one or more 0.5 inch (1.25 cm) taps that protrude far enough from the column or wall to make it easy to fill the water containers. The taps can be a globe or a self-closing type.

The residual pressure head of the water at the standpost should be 10–30 m, and some standposts have a regulating valve in the connection to the mains that can be set and locked to limit the maximum flow. A water meter may also be included (see Fact Sheet 7.8 *Domestic water meters*). A solid stone or concrete apron under the taps, and a drainage system, lead spilled water away and prevent muddy pools from forming. A fence may be needed to keep cattle away. The location and design of a public standpost should be determined in close cooperation with future users.

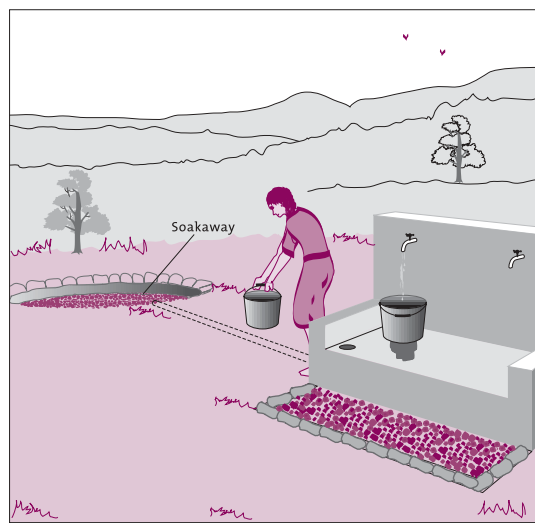

Figure 7.6 Public standpost

7.6.2 Main O&M activities

Water users clean and fill their containers at the tap (bathing and washing clothes are not usually permitted at the standpost itself). At all times, pools of water must be prevented. The tap site should be cleaned daily and the drain inspected. The drain must be cleaned at least once a month. Occasionally, a rubber washer or other tap part may have to be replaced, and the fence may need to be repaired. If the standpost structure becomes cracked, it must be repaired, and when wood rots it must be treated or replaced. Occasionally, the piping may leak and need to be replaced. For maintenance of a water meter, see Fact Sheet 7.8 *Domestic water meters*.

A caretaker or tap committee may be appointed to keep the tap functioning and the surroundings clean, and to regulate the amount of water used. Committee members may

¹ Jordan (1984).

also collect the fees for water use. Sometimes, water vendors are allowed to fill their tanks at public standposts at special rates, for resale to people living farther away.

7.6.3 Actors and their roles

Actors	Roles	Skills required
User.	Keep the site clean.	☺
Caretaker or tap committee.	Clean the site, perform small repairs, collect fees.	✘
Communal water committee.	Organize major repairs, collect fees.	✘
Mason	Repair the standpost and apron	✘✘
Plumber	Repair the piping and taps	✘✘
External support	Monitor hygiene, train committee members	✘✘✘

☺ Simple (often requires gender-specific awareness-raising, and training activities to change behaviour and build capacity);
 ✘ Basic skills. ✘✘ Technical skills. ✘✘✘ Highly qualified.

7.6.4 O&M technical requirements

Activity and frequency	Materials and spare parts	Tools and equipment
Daily		
— test the tap;		Jar, bucket, can, etc.
— clean the site;		Broom or brush.
— inspect and clean the drain.		Hoe, spade.
Occasionally		
— repair or replace the tap valve;	Rubber or leather washer, gland seal, Teflon tape, flax, spare valve.	Spanners, screwdriver, pipe wrench.
— repair the fence;	Wood, steel wire, nails.	Machete, pliers, hammer.
— repair the tapstand, apron or drain;	Wood, nails, cement, sand, water, etc.	Hammer, saw, trowel, bucket, etc.
— repair the piping.	Pipe nipples, connectors, elbows, oil, Teflon tape, flax or plumbing putty.	Pipe wrench, pipe cutter, saw, file, pipe threader.

7.6.5 Potential problems

- if social problems remain unsolved, or if the standpost is not conveniently located, this can lead to the tapstand not being maintained properly, or even vandalised;
- often, the taps are not closed after use, or even left open on purpose to irrigate a nearby plot, which can lead to water accumulation at the tapstand site;
- standposts at the end of a piped system often have insufficient water pressure;
- special attention should be given to how water is handled after collection at the standpost, to prevent the water from subsequently becoming contaminated.

7.7 Domestic connection¹

7.7.1 The technology

When enough water and funds are available, the best option is to connect every house or yard to a piped water system. This is more convenient for water users, generally increases water use, and improves hygiene. A service pipe, usually made of PE or PVCu, leads from the distribution network to the house or yard. The domestic connection can consist of a single tap on a post, or a system of pipes and taps in a house. A gate valve and a water meter are normally installed at the entry to the premises. Drainage must also be provided. The residual head of water (pressure) at household connections should be 10–30 m.

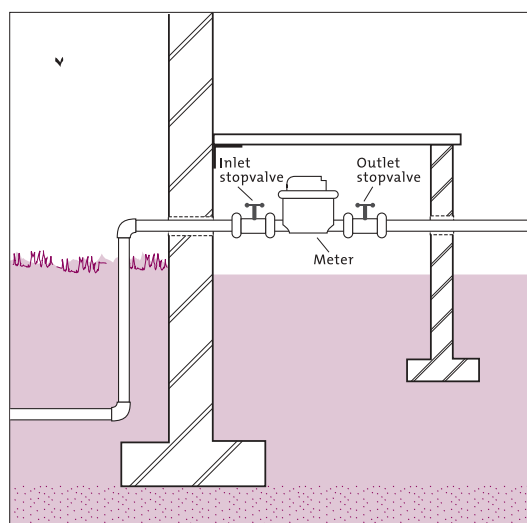

Figure 7.7 Household connection

Initial cost: Depends on factors, such as whether the domestic connection extends into a house, the type of piping material used, whether PE or PVCu pipes are available locally, etc.

Users per connection: Usually, one family.

Yield: Depends on the pressure of the public main, diameter of the household connection, and demand.

7.7.2 Main O&M activities

Taps are used throughout the day. They should not be left open or leak, otherwise mud and pools will form, which must be avoided. The tap and site must be cleaned regularly and the drain inspected. In case of leakage, a rubber washer or other part of the tap may need to be replaced. Any structure on the tap site and drainage system may need to be repaired. Occasionally, the service pipe, fittings and accessories may leak and need to be repaired or replaced. O&M of the domestic connection are carried out by the household itself, or by a community water committee. When water is scarce, or if the pressure is too low in part of the network, the water committee has to motivate users to limit their water use, or create conditions that will induce users to reduce water consumption (e.g. a tariff structure that discourages excessive water use).

7.7.3 Actors and their roles

Actors	Roles	Skills required
User.	Keep the site clean.	😊
Mason.	Repair the standpost and apron.	✂✂
Plumber.	Repair the piping and taps.	✂✂
Water committee.	Monitor hygiene habits, train household members.	✂
External support.	Check the water quality, train members of the water committee.	✂✂✂

© Simple (often requires gender-specific awareness-raising, and training activities to change behaviour and build capacity); ✂ Basic skills. ✂✂ Technical skills. ✂✂✂ Highly qualified.

¹ Jordan (1984).

7.7.4 O&M technical requirements

Activity and frequency	Materials and spare parts	Tools and equipment
Daily		
— check that the tap closes properly and does not leak;		Jar, bucket, can, etc.
— clean the site;		Broom or brush.
— inspect and clean the drain.		Hoe, spade.
Occasionally		
— repair or replace the valve;	Rubber or leather washer, gland seal, Teflon tape, flax, spare valve.	Spanners, screwdriver, pipe wrench.
— repair the valve stand, apron or drain;	Wood, nails, cement, sand, water, etc.	Hammer, saw, trowel, bucket, etc.
— repair the piping.	Pipe nipples, connectors, elbows, oil, Teflon tape, flax or plumbing putty.	Pipe wrench, pipe cutter, saw, file, pipe threader.

7.7.5 Potential problems

- leaks may not be repaired and water will be wasted;
- if too much water is lost from the system, or if water becomes scarce, it may be difficult to ensure that everyone has water, which could lead to the inequitable distribution of water;
- initial costs for household connections are higher, and it is complicated to maintain the distribution network.

7.8 Domestic water meter¹

7.8.1 The technology

Water meters, in combination with public standposts or domestic connections, provide the means to charge fees according to the volume of water delivered, and to regulate water use via tariffs. Water meters consist of a device to measure flow, and a protective housing with an inlet and an outlet. A strainer over the inlet keeps larger particles out of the system. There are many types of water meter, but for ordinary domestic or public standpipe use, turbine meters are most common. The vane wheel and the counting device of a water meter can be coupled magnetically or directly. Magnetic coupling has the advantage that the counting device can be completely sealed and no water, silt or algae will get in. A shut-off valve is normally installed on both sides of the meter to allow for servicing.

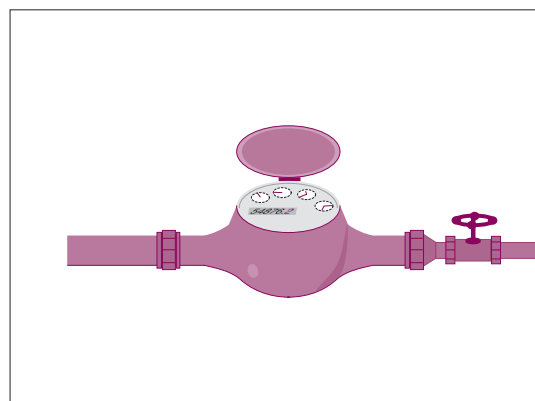

Figure 7.8 Caption? Water meter

Initial cost: From US\$ 10–25 or more, not including installation costs.

Flow range: 0.005–1.5 litres/s for domestic use.

Area of use: Piped public water distribution systems.

Manufacturers: Biesinger; Bosco; Kent; Schlumberger; Spanner Pollux; Valmet, etc.

¹ van Wijk-Sijbesma (1987); Jeffcoate & Pond (1989).

7.8.2 Main O&M activities

On a regular basis (e.g. every month), the water meter should be read by an appointed person who writes down the new meter count in a book. The difference between two readings of the same meter is the amount of water used, and consumers will be billed accordingly. The reader must check that the meter is in good condition and has not been tampered with. Meter counts can also serve to regulate consumption, by raising tariffs as more water is used. The fee for a meter reader increases the operational costs of the system, but the costs may be partly offset because the domestic water meters (and distribution network water meters) help to control leaks and the wasting of water.

When the water is free of silt, a good-quality water meter needs very little maintenance; however, a specialized workshop is needed for repairs. It is advisable to clean the strainer at least once a year, depending on the meter and water quality. When the meter no longer functions well, it should be replaced or recalibrated. Water meters lose accuracy with time, and about every five years a meter should be cleaned and recalibrated regardless of its status (defined according to the nature of the water and the meter type). To recalibrate it, the meter should be sent to a specialized workshop for inspection, repair and calibration.

A water meter is often owned by the water users themselves, who guarantee that it is treated well. Even when the external parts of a water meter belong to a water committee or project, the users may still be responsible for the condition of the parts. A water committee will need to keep a stock of water meters for replacing defective ones. To reduce costs, the number of different models should be kept to a minimum.

7.8.3 O&M requirements

Activity	Materials and spare parts	Tools and equipment
Monthly		
— read the meter;	Notebook, pencil.	
— check the condition of the meter.		
Annually		
— clean the strainer.		Spanners, screwdriver.
Occasionally		
— replace the meter;	Spare meter, Teflon tape or flax.	Spanners, pipe wrench.
— check the accuracy of the meter;	Water.	Spanners, pipe wrench, calibrated meter, nipples.
— repair the meter and calibrate it.	Depends on the model of water meter.	Meter workshop with calibration rig.

7.8.4 Potential problems

- the meter may become inaccurate, tampered with, stolen, damaged by cattle, or damaged by grit in the water;
- grit or soft debris may clog the strainer;
- the initial cost and operational costs of a water meter are relatively high;
- domestic water meters should not be used with water with a high silt load;
- some meter counters are more difficult to read than others, which can be a problem for both user and meter reader, and may require good skills on the part of the reader.

8. Sanitation

8.1 Introduction

Sanitation includes solid waste disposal (including medical wastes), wastewater disposal, wastewater reuse, human excreta disposal, and drainage of surface (rain) water. This section deals mainly with systems for human excreta disposal, in line with the scope of this document. A distinction is made between systems that do not need water (dry systems) and systems that need water to function (waterborne systems). The following systems are described in the Fact Sheets, and they cover a wide range of technologies for disposing of human excreta, from simple improved traditional latrines, to complex sewerage systems:

- basic improved traditional latrine;
- ventilated improved pit latrine;
- double-vault compost latrine;
- bored hole latrine;
- pour-flush latrine with leaching pit;
- septic tank and aqua privy;
- vacuum tanker;
- manual latrine-pit emptying technology (MAPET);
- soakaway;
- drainage field;
- small-bore or settled sewerage.

Sludge and effluent treatment technologies, such as stabilization ponds and aeration ponds, are not included as they are beyond the scope of this publication. Bucket collection of excreta also has not been included, because the collection, transportation and disposal of excreta by this method are usually uncontrolled and unhygienic, and pose health risks both to the collectors and to the community.

Safe human excreta disposal is crucial for preventing the spread of infectious diseases. Communities and planners need to realize that safe human excreta disposal brings about huge health benefits. The control and management of wastes are an essential part of O&M. In rural areas, the users themselves are largely involved in preventive maintenance activities for wastewater and solid waste disposal. Awareness campaigns, and involving the community in sanitation problems, can both help to change behaviour in communities, and improve the O&M of basic sanitation systems.

Factors to consider when choosing a sanitation system for excreta disposal include:

- the initial cost of the technology and the costs of O&M;
- demand and use (what is the population density, and will the system be used in homes, schools, market places?);
- climate (temperature, humidity and rainfall);
- soil and topography (infiltration properties of the soil, and what is the direction of the groundwater flow?);
- water availability (for waterborne systems);
- cultural beliefs, values and practices around sanitation;

- the availability of technical skills (are there local craftsmen or technicians with the necessary skills to install and/or carry out O&M of the system?);
- agriculture (what are the characteristics of the local agriculture and home gardening).

8.1.1 Waterborne systems for excreta disposal

Wastewater coming from kitchens and bathrooms is termed “sullage” (or grey water). “Sewage” (or black water), includes sullage and human excreta from waterborne facilities. Sewage is called “sludge” when it becomes a thick mud. In areas of high population density, wastewater can pose a serious public-health threat, such as when it surfaces during flooding, or when there is no proper drainage. Not only would it cause foul odours, but it would also be a source of pathogens. If sewer pipes break, or if wastewater stagnates because the soil absorbs poorly, the wastewater could seep into the drinking-water supply and contaminate it.

The problems associated with waterborne waste disposal are: the high water consumption; the sewer system often becomes blocked; and the high capital and O&M costs.

Some O&M considerations associated with four options for dealing with a full pit latrine are shown in Table 8.1. Disposal options are considered in Table 8.2.

8.1.2 Dry sanitation systems for excreta disposal

One dry sanitation method is to dehydrate the human faeces. Special collection devices, which divert urine into a separate container for storage, allow faeces to be dehydrated fairly easily. The urine can be used directly as a fertilizer, since urine contains most of the nutrients and the risks from pathogens are relatively low. The classic example of an ecological sanitation system based on dehydration is the Vietnamese double-vault toilet. In Northern Vietnam, a common practice was to fertilize rice fields with fresh excreta. To combat this hazardous practice, in 1956, the health authorities started campaigns to construct double-vault dry latrines, and followed this up with health education programmes. It is now widely used in Vietnam, and to some extent in Central America, Mexico and Sweden.

A second dry sanitation method is to compost the human faeces. This involves a biological process in which bacteria and worms break down the organic material under controlled conditions (e.g. temperature, moisture, and airflow) and make humus. If the composting conditions are properly controlled, the humus is free of human pathogens and is an excellent soil conditioner. A drawback of this method is that in many developing countries it is likely that the composting conditions would not be controlled properly, which could lead to humus contaminated with pathogens.

The health aspects of dry sanitation systems, either by dehydration or composting, are not well understood yet and these technologies cannot be recommended without a clear understanding of how they function, especially where O&M are unlikely to be adequate. In addition, the most unfamiliar aspect of dry sanitation is that it requires some handling of human faeces at household level, which for many is still taboo and may involve health risks. Nevertheless, if communities wish to consider ecological sanitation technologies, they should be made aware of the importance of maintaining the technology in good working order, and of the consequences should the technology malfunction.

The most common problems with dry sanitation are:

- The faeces become wet (>25% humidity), and therefore smells persist, flies breed, and pathogens survive. This could be caused by leaking urine conduits or blocked vent pipes, or poor maintenance of the system. Absorbents like ash, lime, sawdust, husks, crushed dry leaves, peat moss and dry soil are used to absorb excess mois-

ture, as well as to reduce smells and make the pile less compact. Ventilation also helps to dry the contents, and also removes smells, allows flies to escape and, in the case of composting toilets, provides oxygen for the decomposition process.

- Cleaning material is used inappropriately after defecation.

8.2 Improved traditional pit latrine¹

8.2.1 The technology

Traditional latrines usually consist of a single pit covered by a slab with a drop hole and a superstructure. The slab may be made of wood (sometimes covered with mud) or reinforced concrete. The superstructure provides shelter and privacy for the user. Basic improvements include:

- a hygienic self-draining floor made of smooth, durable material and with raised foot rests;
- a tight-fitting lid that covers the drop hole, to reduce smells and keep insects out of the pit;
- a floor raised at least 0.15 m above ground level, to prevent flooding;
- an adequately lined pit, to prevent the pit collapsing (e.g. when the soil is unstable);
- an adequate foundation, to prevent damage of the slab and superstructure.

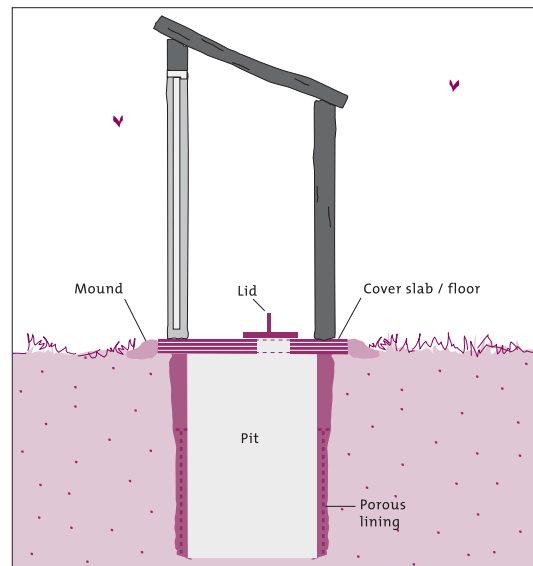

Figure 8.2 Traditional pit latrine

The pits can be square, rectangular or circular, usually 1.0–1.5 m wide. The depth (usually 3–5 m) depends on the soil and groundwater conditions. In unstable soil, or when the pit is going to be emptied, some kind of lining (e.g. old oil drums or stones) is needed. A foundation may be needed to support the slab and superstructure.

As a general rule, pits should be at least 15–30 m from sources of drinking-water. The actual distance will depend on local hydrogeological conditions, such as soil characteristics, and groundwater depth and flow. When groundwater levels are high, or when the soil is too hard to dig, the pit latrine may have to be raised above ground level.

Initial cost: Initial costs of construction should include materials (50–80%), transportation (0–25%) and local labour (15–35%). Actual costs will depend on: the pit volume; the quality of the pit lining, slab and superstructure; whether materials are available locally; and the local costs of materials and labour.

Area of use: Rural and low-income urban areas. Mainly used as a household facility and for rural institutions.

8.2.2 Main O&M activities

Operation of pit latrines is quite simple, and consists of regularly cleaning the slab with water (and disinfectant) to remove any excreta and urine. The tight-fitting lid over the drop hole should be replaced after use, to ensure insect control and to reduce odours. In

¹ Sources: Wegelin-Schuringa (1991); Franceys, Pickford & Reed (1992).

TABLE 8.1 WHAT TO DO WITH A FULL PIT LATRINE?^a

1. Stop using the latrine	2. Empty latrine by hand	3. Empty by simple mechanical means	4. Empty using a tanker
Back-fill the top of the latrine with soil, and build another. If possible, build twin-pit latrines, which are shallow and “reusable”.	Dig out the contents of the latrine using a spade and bucket.	Use a simple device (e.g. MAPET) with a manpowered suction pump, that is easy to manoeuvre in narrow streets and courtyards.	Use a motorized tanker with a vacuum pump.
Limitation(s) <ul style="list-style-type: none"> • Many families or schools do not have sufficient space to build another latrine, and they continue to use the one they have. This creates very high health risks. 	Limitation(s) <ul style="list-style-type: none"> • This method involves very high health risks. • If the pit is not “lined” with walls of stones, bricks or concrete, it might collapse when it is emptied. • Sludge could be deposited in an unsafe place. 	Limitation(s) <ul style="list-style-type: none"> • The informal sector does not always have the necessary equipment. • The suction pump may not be powerful enough to raise sludge from a deep latrine. • If the pit is not “lined” with walls of stones, bricks or concrete, it could collapse when it is emptied. • Sludge could be deposited in an unsafe place. 	Limitation(s) <ul style="list-style-type: none"> • Large vehicles have problems manoeuvring in narrow streets and courtyards. • Motorized tankers are expensive to buy. • Users pay more for the service.

^a Adapted from Pickford & Shaw (1997). A full pit latrine is defined as one that is filled to within one-half metre of ground level.

TABLE 8.2 WHAT TO DO WITH SLUDGE FROM PIT LATRINES AND SEPTIC TANKS?^a

Possible solutions	Method
Disposal into water.	Sludge can be disposed into water, if it is left untouched for about 2 years. However, untreated sludge poses very high risks to health and the environment.
Disposal onto land.	Sludge can be disposed onto land, if it is left untouched for about 2 years. However, untreated sludge poses very high risks to health and the environment.
Composting.	Mix the sludge with 2–3 times its volume of vegetable waste. Turn it several times in the first few weeks, then heap it into a pile and leave it for several weeks. After this, it can be used as fertilizer.
Household bio-gas units.	Add latrine or septic tank sludge to bio-gas units (mainly used with animal waste).
Drying beds.	Sludge flows into a shallow tank that allows drainage, and is covered with a layer of sand. The sludge is then lifted after about one week.
Solid-liquid separation.	Solids are separated from the liquid wastes by sedimentation or rough filtering. The solids are then lifted.
Anaerobic digestion.	Sludge from the latrine is added to wastewater sludge, and separated by sedimentation at wastewater treatment plants.
Extended aeration.	The sludge is aerated. O&M is expensive.
Sewerage system.	Sludge is discharged into wastewater treatment plants. The rate of discharge is important for this method to work properly.
Waste stabilization ponds.	The sludge is treated in waste stabilization ponds, either with municipal wastewater, or separately.

^a Adapted from Pickford & Shaw (1997).

addition, appropriate anal cleansing materials should be available in or near the latrine. Ash or sawdust can be sprinkled into the pit to reduce the smell and insect breeding. Nonbiodegradable materials, such as stones, glass, plastic, rags, etc., should not be thrown into the pit, as they reduce the effective volume of the pit and hinder mechanical emptying.

Monthly maintenance includes checking the slab for cracks, checking the superstructure for structural damage, ensuring that the lid remains tight-fitting, and ensuring that the surface water continues to drain away from the latrine. Before the pit latrine becomes full, a decision must be made as to the location of a new pit. Time must be allowed for digging the new pit and transferring the slab and superstructure to it. The contents of the old pit must then be covered with at least 0.5 m of top soil, to hygienically seal it off. When latrines are used by a single household, O&M tasks are implemented by the household or by hired labour. If several households use the latrine, arrangements for rotating the cleaning tasks have to be made, to avoid social conflict. Pits can only be emptied manually if their contents have been left to decompose for about two years. Otherwise, when a pit is full, it must be emptied mechanically, or a new pit has to be dug.

8.2.3 Actors and their roles

Actors	Roles	Skills required
User.	Use the latrine, close the lid, keep the latrine clean, inspect the latrine and perform small repairs on it.	☺
User or local labour.	Dig a new pit; shift, or transfer the slab and superstructure.	☺
Local mason.	Build and repair the latrine.	✂✂
Health department.	Monitor latrines and hygienic behaviour of users, and train users in hygienic behaviour.	✂✂✂

☺ Simple (often requires gender-specific awareness-raising, and training activities to change behaviour and build capacity);
 ✂✂ Technical skills. ✂✂✂ Highly qualified.

8.2.4 O&M technical requirements

Activity and frequency	Materials and spare parts	Tools and equipment
Daily		
— clean the drop hole, seat and shelter;	Water, soap.	Brush.
— clean the handle of the lid.	Water, soap.	Brush.
Monthly		
— inspect the floor slab and lid.		
Occasionally		
— repair the slab, lid, seat or superstructure.	Cement, sand, water, nails, local building materials.	Bucket or bowl, trowel, saw, hammer, knife.
Depending on size and number of users		
— close the pit with soil, dig a new pit, shift cover and superstructure;	Soil, local building materials and nails (if available).	Shovels, picks, bucket, hammer, knife, saw, etc.
— empty the pit (if applicable).	By hand: water. By mechanical means: water, spare parts for machinery.	By hand: shovel, bucket. By mechanical means: equipment for emptying the pit.

8.2.5 Potential problems

- the slab floor cracks, because it was constructed with unsuitable materials or because the concrete was not cured properly, and the cracks provide a habitat for parasites;
- the latrine lid gets damaged or falls into the pit;
- in hard soils it may be impossible to dig a proper pit;
- pits often fill up too quickly in soils with low infiltration and leaching capacity;
- when children are afraid of using a latrine, special children's latrines may be constructed with a smaller drop hole.

8.3 Ventilated improved pit latrine¹

8.3.1 Brief description of the technology

Ventilated Improved Pit (VIP) latrines are designed to reduce two problems frequently encountered with traditional latrine systems: bad odours and insect proliferation. A VIP latrine differs from a traditional latrine by having a vent pipe that is covered with a fly screen. Wind blowing across the top of the vent pipe creates a flow of air which draws out odours from the pit. As a result, fresh air is drawn into the pit through the drop hole and the superstructure is kept free of smells. The vent pipe also has an important role to play in fly control. Flies are attracted by light and if the latrine is suitably dark inside, they will fly up the vent pipe towards the outside light, where they are trapped by the fly screen and die of dehydration. Female flies, searching for an egg-laying site, are attracted by the odours from the vent pipe, but are prevented from flying down the pipe by the fly screen at its top. VIP latrines can also be constructed with a double pit. The latrine has two shallow pits, each with its own vent pipe, but only one superstructure.

The cover slab has two drop holes, one over each pit, but only one pit is used at a time. When one becomes full, the drop hole is covered and the second pit is used. After about two years, the contents of the first pit can be removed safely and used as soil conditioner. The first pit can be used again when the second pit has filled up. This alternating cycle can be repeated indefinitely.

Initial cost: A single-pit VIP family latrine costs US\$ 70–400, while the double-pit VIP version costs US\$ 200–600. These costs include materials (60–80%), transportation (5–30%) and local labour (10–25%). Actual costs will depend on the pit volume; the quality of the lining, slab and superstructure; whether materials are available locally; and local prices.

Area of use: Household and community level in rural and periurban areas.

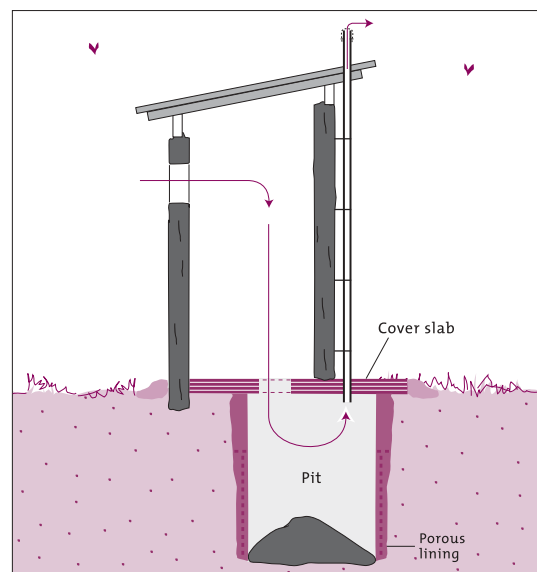

Figure 8.3 Ventilated improved pit latrine

¹ Sources: Smet et al. (1988); Wegelin-Schuringa (1991); Franceys, Pickford & Reed (1992).

8.3.2 Main O&M activities

Operation of pit latrines is quite simple and consists of regularly cleaning the slab with water and disinfectant, to remove any excreta and urine. The door must always be closed so that the superstructure remains dark inside. The drop hole should never be covered as this would impede the airflow. Appropriate anal cleaning materials should be available for the latrine users. Nonbiodegradable materials, such as stones, glass, plastic, rags, etc. should not be thrown into the pit, as they reduce the effective volume of the pit and hinder mechanical emptying.

Every month, the floor slab should be checked for cracks, and the vent pipe and fly screen inspected for corrosion or damage, and repaired if necessary. The superstructure may also need to be repaired (especially light leaks). Rainwater should drain away from the latrine. When the contents of the pit are 0.5 m below the slab, a new pit should be dug and the old one covered with soil. Alternatively, the pit could be emptied mechanically.

Where latrines are used by a single household, O&M tasks are implemented by the household, or by hired labour. If several households use the latrine, arrangements have to be made to rotate the cleaning tasks, to avoid social conflicts. If pits are not emptied mechanically, they can be emptied manually, but only after their contents have been left to decompose for about two years. Otherwise, new pits must be dug when a pit is full. If double-pit latrines are used, the users need to understand the concept of the system fully to operate it properly. User education has to cover topics such as the reasons for using only one pit until the time for switch-over; the use of excreta as manure; and the need to leave the full pit for about two years before emptying. The users must also know how to switch pits and how to empty them, even if they do not do these tasks themselves. If these tasks are carried out by the private (informal) sector, the workers have to be educated about the system and its operational requirements.

8.3.3 Actors and their roles

Actors	Roles	Skills required
User.	Keep the latrine clean, inspect and perform small repairs, empty the full pit and switch to the new one, dig a new pit and replace the latrine.	☺
Local unskilled labour (sweepers/scavengers).	Dig pits, transfer structures, empty full pits in double-pit systems, perform small repairs, solve small problems.	✂✂
Local mason.	Build, repair and transfer latrines.	✂✂
Health department.	Monitor latrines and the hygienic behaviour of users, educate users in good hygiene practices.	✂✂✂

☺ Simple (often requires gender-specific awareness-raising, and training activities to change behaviour and build capacity);

✂✂ Technical skills. ✂✂✂ Highly qualified.

8.3.4 O&M technical requirements

Activity and frequency	Materials and spare parts	Tools and equipment
Daily		
— clean the drop hole, seat and superstructure.	Water, soap.	Brush, bucket.
Monthly		
— inspect the floor slab, vent pipe and fly screen.		
Every 1–6 months		
— clean the fly screen and the inside of the vent.	Water.	A twig or long flexible brush.
Occasionally		
— repair the slab, seat, vent pipe, fly screen or superstructure.	Cement, sand, water, nails, local building materials.	Bucket or bowl, trowel, saw, hammer, knife.
Depending on size and number of users		
— dig a new pit and transfer latrine slab and superstructure (if applicable);	Sand, possibly cement, bricks, nails and other local building materials.	Shovels, picks, buckets, hammer, saw, etc.
— switch to the new pit when the old pit is full;		Shovels, buckets, wheelbarrow, etc.
— empty the old pit (if applicable).	By hand: water. By mechanical means: water and spare parts for the machinery.	By hand: shovel, bucket. By mechanical means: equipment for emptying the pit.

8.3.5 Potential problems

- the quality of the floor slab is poor because inappropriate materials were used in its construction, or because the concrete was not properly cured;
- inferior quality fly screens are easily damaged by the effects of solar radiation and foul gases;
- badly-sited latrines can get flooded or undermined;
- children may be afraid to use the latrine because of the dark, or out of fear of falling into the pit;
- if the superstructure allows too much light to come in, flies will be attracted to the light coming through the squat hole and may fly out into the superstructure, which can jeopardize the whole VIP concept;
- in latrines that rely on solar radiation for the air flow in the vent pipe, rather than on wind, odour problems may occur during the night and early morning hours;
- leakage between pits occurs because the dividing wall is not impermeable or the soil is too permeable;
- in hard soils it may be impossible to dig a proper pit;
- pits should preferably not reach the groundwater level and must be 15–30 m from ground and surface water sources;
- VIP latrines do not prevent mosquitoes from breeding in the pits;
- VIP latrines cost more to construct than simple pit latrines and the community may not be able to bear the higher costs;
- cultural resistance against handling human waste may prevent households from emptying their own pit latrines, but usually local labour can be hired to do the job.

8.4 Double-vault compost latrine¹

8.4.1 The technology

The double-vault compost latrine consists of two vaults (watertight chambers) to collect the faeces. Urine is collected separately, because the contents of the vault should be kept relatively dry. Initially, a layer of absorbent organic material is put in the vault, and after each use the faeces are covered with ash (or sawdust, shredded leaves or vegetable matter) to reduce smells and soak up excessive moisture. The organic material also ensures that sufficient nitrogen is retained in the compost to make it good fertilizer. When the first vault is three-quarters full, it is completely filled with dry, powdered earth and sealed, and the contents allowed to decompose anaerobically. The second vault is then used and when it is three-quarters full, the first

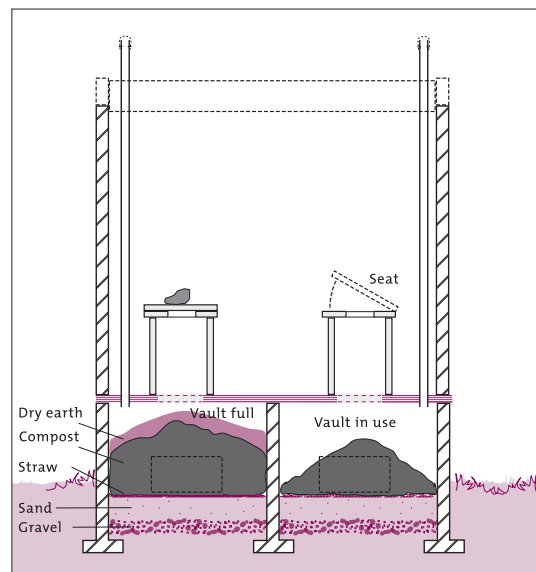

Figure 8.4 Double-vault compost latrine

vault can be emptied (even by hand) and the contents used as fertilizer. The vaults should be large enough to keep the faeces long enough for them to become pathogen-free (at least two years). A superstructure is built over both vaults, and each has a squat hole that can be sealed off. The latrine can be built anywhere, since the vaults are watertight and there is no risk of polluting the surroundings. Where there is rock or a high water-table, the vaults can be placed above ground. A ventilation pipe keeps the aerobic system active, which is essential for composting. Double-vault latrines have been successfully used in Vietnam and Central America (El Salvador, Guatemala, Honduras, Nicaragua).

8.4.2 Main O&M activities

Initially, some absorbent organic material is put into the empty vault (layer of ashes or lime) to ensure that liquids are absorbed and to prevent the faeces from sticking to the floor. After each use, or whenever available, wood ash and organic material are added. When urine is collected separately it is often diluted with 3–6 parts of water and used as a fertilizer. Water used for cleaning should not be allowed to go into the latrine as it will make the contents too wet. When the vault is three-quarters full, the contents are levelled with a stick, the vault is filled to the top with dry powdered earth, and the squat hole is sealed. The second vault is then emptied with a spade and bucket, after which the vault it is ready for use. The contents dug out of the second vault can be safely used as fertilizer. To help keep down the number of flies and other insects, insect-repelling plants (such as citronella) could be grown around the latrine.

Potential users of a vault latrine technology should be consulted extensively, to find out if the system is culturally acceptable, and if they are motivated and capable of operating and maintaining the system properly. The project agency will need to provide sustained support to ensure that users understand the system and operate it properly.

¹ Winblad & Kilama (1985); Franceys, Pickford & Reed (1992).

8.4.3 Actors and their roles

Actors	Roles	Skills required
User/household.	Use latrine, remove urine, help keep latrine clean, inspect and perform small repairs, help to empty the pit and switch over to the new pit.	☺
Local mason.	Build and repair latrines.	✂✂
Local pit emptier.	Empty the pit and switch over to the new pit, check the system and perform small repairs.	✂✂
External support organization.	Investigate whether the double-vault technology is appropriate, monitor users' O&M and hygienic behaviour and provide feedback, train users and local artisans.	✂✂✂

☺ Simple (often requires gender-specific awareness-raising, and training activities to change behaviour and build capacity);
 ✂✂ Technical skills. ✂✂✂ Highly qualified.

8.4.4 O&M technical requirements

Activity and frequency	Materials and spare parts	Tools and equipment
Daily		
— clean the toilet and superstructure, empty the urine collection pot.	Water, lime, ashes.	Brush, water container.
After each defecation or whenever available		
— add ashes or other organic material.	Wood ashes and organic material.	Pot to contain the material, small shovel.
Monthly		
— inspect the floor, superstructure and vaults.		
When necessary		
— repair the floor, superstructure or vaults;	Cement, sand, water, nails, local building materials.	Bucket or bowl, trowel, saw, hammer, knife.
— use humus as fertilizer.	Humus.	Shovel, bucket, wheelbarrow.
Depending on size and number of users		
— close the full vault after levelling and adding soil;	Water, absorbent organic material.	Shovel and bucket.
— empty the other vault, open its squat hole and add 10 cm of absorbent organic material before using;		
— store the humus, or use it directly.		

8.4.5 Potential problems

- users do not understand how to operate the system properly and leave the latrine contents too wet, which makes the vault malodorous and difficult to empty;
- users are too eager to use the latrine contents as fertilizer and do not allow sufficient time for the compost to become pathogen-free;
- the double-vault compost latrine can only be used where people are motivated to use human excreta as a fertilizer;
- the double-vault compost latrine is not appropriate where water is used for anal cleansing.

8.5 Bored-hole latrine¹

8.5.1 The technology

Mainly used in emergency situations. A bored-hole latrine is similar to a basic improved traditional latrine, but the pit is a hole bored with a soil auger (either mechanically or manually). The borehole diameter is at least 0.4 m, and the pit is 4–10 m deep. The relatively small diameter permits a simpler, smaller, lighter and cheaper floor slab and foundation, but limits the storage capacity. A bored-hole latrine is suitable for stable, permeable soils, free of stones, and where the groundwater is deep beneath the surface. The top 0.5 m of the pit is often lined to provide support for the slab, but the pit is not lined all the way to the bottom.

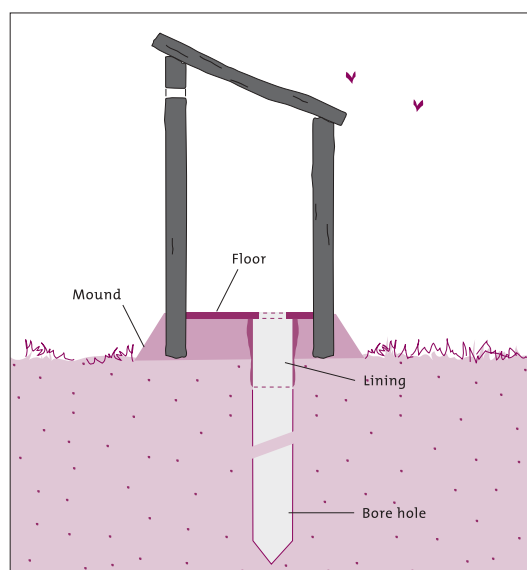

Figure 8.5 Bored-hole latrine

Initial cost: There are no hard data on prices. Costs would depend on the soil and other local conditions, labour costs, the materials used in building the latrine, and the efficiency of organization.

Area of use: Emergency areas with permeable stable soils, low groundwater, and no stones.

8.5.2 Main O&M activities

Operation of the latrines is quite simple and consists of regularly cleaning the slab with water and disinfectant. The tight-fitting lid should be replaced after use, to control insects and reduce smell. In addition, appropriate anal cleansing materials should be available in or near the latrine. Ash or sawdust can be sprinkled in the pit to reduce odours and insect breeding. Nonbiodegradable materials, such as stones, glass, plastic, rags, etc., should not be thrown in the pit as they reduce the effective volume of the pit and hinder mechanical emptying. Monthly maintenance includes checking the slab for cracks, checking the superstructure for structural damage, ensuring that the lid remains tight-fitting, and ensuring that the surface water continues to drain away from the latrine. Before the latrine becomes full, a decision must be made as to the location of a new pit. Time must be allowed for digging the new pit and transferring the slab and superstructure to it. The contents of the old pit must then be covered with at least 0.5 m of top soil to hygienically seal it off.

In emergencies, sanitation programmes tend to be more top-down oriented, and users are instructed on how to build their latrines, or the latrines are built for them. In most emergency situations, people have ample time and opportunity and are very motivated to be involved, but strict hygiene control is essential. Often, several families use the same latrine, and a caretaker or responsible committee should be appointed to organize cleaning and maintenance and to motivate proper use.

¹ Wegelin-Schuringa (1991); Franceys, Pickford & Reed (1992).

8.5.3 Actors and their roles

Actors	Roles	Skills required
User.	Use latrine, close lid, keep latrine clean.	☺
Caretaker or latrine committee.	Clean latrine, motivate proper use, perform small repairs.	✳
Health department.	Monitor latrines and hygiene behaviour of users, train users in hygienic practices.	✳✳✳

☺ Simple (often requires gender-specific awareness-raising, and training activities to change behaviour and build capacity);
 ✳ Basic skills. ✳✳✳ Highly qualified.

8.5.4 O&M technical requirements

Activity and frequency	Materials and spare parts	Tools and equipment
Daily		
— clean the drop hole, and superstructure.	Water, soap.	Brush.
Monthly		
— inspect the floor slab and lid.		
Occasionally		
— repair the slab, lid or superstructure.	Cement, sand, water, nails, local building materials.	Bucket or bowl, trowel, saw, hammer, knife.

8.5.5 Potential problems

- the small diameter of the hole increases the chance of blockage;
- the sides of the hole become soiled near the top, leading to fly infestation;
- the pit cannot be bored, because the soil is too hard, or too stony, etc., in which case a dug latrine may be more appropriate;
- as bored holes are relatively deep there is a risk of groundwater contamination.

8.6 Pour-flush latrine¹

8.6.1 The technology

Pour-flush leaching pit latrines overcome the problems of flies, mosquitoes and odour by having a pan with a water seal (a U-shaped conduit partly filled with water) in the defecation hole. After using the latrine, it is flushed by pouring water in the pan. The latrine pits are usually lined to strengthen the walls, and the soil should be adequately permeable for infiltration. The concrete floor slab with the pan is either on top of the leaching pit (direct system), or a short distance from one pit (single offset) or two pits (double offset). In offset systems, a short length of PVC tubing slopes down from the U-trap to the pit, or in case of a double-pit system, to a diversion box which diverts the flush into one of the two pits. The double offset system enables the two pits to be used alternately. When the first pit is full, it should be left for at least 12–18 months, to allow time for the pathogens to be destroyed. After this time, the contents of the first pit can be safely removed even by hand and used as organic fertilizer. The first pit is then ready to be used when the second pit fills up. Double-offset pits are usually smaller than single pits because they need to last for only 12–18 months. Pour-flush latrines are most suitable where people

¹ Winblad & Kilama (1985); Wegelin-Schuringa (1991, 1993); Bakhteari & Wegelin-Schuringa (1992); Franceys, Pickford & Reed (1992); van de Korput & Langendijk (1993).

use water for anal cleansing and squat to defecate, but they are also popular in countries where other cleansing materials are common. Pour-flush latrines may be upgraded to a septic tank with a drainage field or soakaway, or may be connected to a small-bore sewerage system.

Initial cost: A single-pit system costs US\$ 30–100, and a double-pit system US\$ 75–212. The prices include costs for labour and materials, and for a brick lining and a concrete platform (the superstructure was not included in most cases). Organizational costs are also not included. The lowest prices were in Asia, the highest in Africa, and those in South America were between the two.

Area of use: Rural or periurban areas where sufficient water is available and the soil is permeable.

Flushing: About 2–5 litres per flush, mainly depending on the pan design and the distance to the pit.

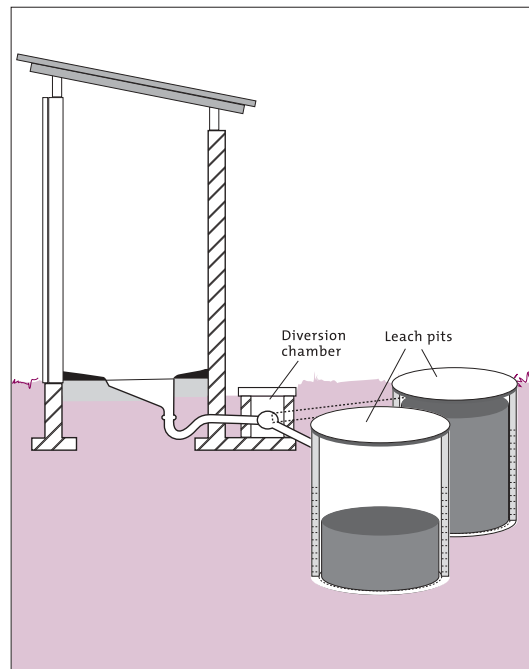

Figure 8.6 Pour-flush latrine

8.6.2 Main O&M activities

Before use, the pan is wetted with a little water to prevent faeces sticking to the pan. After use, the pan is flushed with a few litres of water. If water is scarce, water already used for laundry, bathing, etc. may be used. No material that could obstruct the U-trap should be thrown into the pan. The floor, squatting pan or seat, door handles and other parts of the superstructure should be cleaned daily with brush, soap and water. Wastewater from bathing or washing clothes should not be drained into the pit (except when used for flushing), but disposed of elsewhere. Monthly, the pan and U-trap should be checked for cracks, and the diversion box for blockage. If the excreta does not flush quickly, the PVC pipes or diversion box may become choked and they must be unblocked immediately using scoops and long sticks.

When full, single pits should be abandoned and covered with at least 0.5 m of soil, and a new pit dug. If they are not to be abandoned, they should be emptied by mechanical means. A pit can only be emptied manually if the excreta have been left to decompose for at least 12–18 months. In this time, the excreta will have decomposed into harmless humus, which makes a good fertilizer. In a double-pit system, users should regularly monitor the level of the pit contents. If one pit is almost full, the second pit should be emptied. Again, this can safely be done by hand, but only if the pit to be emptied has been properly closed for at least 12–18 months. The pipe leading to the full pit should then be sealed and the flow diverted to the emptied pit.

If latrines are used by a single household, O&M tasks are carried out by the household itself, or by hired labour. If several households use the latrine, arrangements should be made to rotate cleaning tasks among the households. The users need to understand the concept of the system fully to be able to operate it properly. User education must include the reasons for using one pit at a time, the need to leave a full pit for about two years before emptying, and the use of excreta as manure. The users also need to know how to switch from one pit to another, and how to empty a pit, even if they do not

perform these tasks themselves. If these tasks are carried out by the private (often informal) sector, the labourers should also be educated in the concept of the system and its O&M requirements.

8.6.3 Actors and their roles

Actors	Roles	Skills required
User.	Use the latrine, flush it, keep it clean, and inspect it and perform small repairs.	☺
Sanitation worker.	Use the latrine, flush it, keep it clean, and inspect it and perform small repairs.	✂✂
Local mason.	Build and repair latrines.	✂✂
Health department.	Monitor latrines and the hygienic behaviour of users, train users in hygienic behaviour.	✂✂✂

☺ Simple (often requires gender-specific awareness-raising, and training activities to change behaviour and build capacity);
✂✂ Technical skills. ✂✂✂ Highly qualified.

8.6.4 O&M technical requirements

Activity and frequency	Materials and spare parts	Tools and equipment
Daily		
— clean the squatting pan or seat and shelter.	Water, soap.	Brush, water container.
Monthly		
— inspect the floor, squatting pan or seat, and U-trap for cracks;		
— inspect the diversion box for blockage.		
Occasionally		
— unblock the U-trap, PVC pipes or diversion box;	Water.	Flexible stick or other flexible tools.
— repair the squatting pan or seat, U-trap or shelter.	Cement, sand, water, nails, local building materials.	Bucket or bowl, trowel, saw, hammer, knife.
Depending on size and users		
— close a full pit with soil and dig a new pit (in the case of a single-pit system);	Soil, several local building materials, and nails.	Shovels, picks, bucket, hammer, knife, saw, etc.
— or, empty the pit;	By hand: water. By mechanical means: water, spare parts for machinery.	By hand: shovel, bucket. By mechanical means: pit-emptying equipment.
— divert excreta flush to the other pit (in the case of a double pit).	Water, sand, cement, bricks, clay etc.	Shovel, bucket.

8.6.5 Potential problems

- the U-trap becomes blocked because of bad design or improper use;
- the U-trap is damaged because the unblocking was not done correctly (sometimes U-traps are broken on purpose to prevent blockage);

- diversion boxes or PVC pipes become blocked;
- excreta in double pits may not decompose completely, because the pits are too close to each other without an effective seal between them and liquids percolate from one pit to the other;
- full-flush pans are sometimes used when pour-flush pans are not available, but they require more water (7–12 litres per flush), which may be a problem if water is limited;
- leaching pits only function in permeable soils;
- latrines must be 15–30 m from water sources;
- pour-flush latrines should only be used in areas with adequate water for flushing;
- pour-flush latrines are not suitable if it is common practice to use bulky materials, such as corncobs or stones, for anal cleansing, because they cannot be flushed through the U-trap;
- an offset system requires more water for flushing than a direct pit system;

8.7 Septic tank and aqua privy¹

8.7.1 The technology

Septic tanks and aqua privies have a water-tight settling tank with one or two compartments. Waste is flushed into the tank by water from a pipe that is connected to the toilet. If the septic tank is under the latrine, the excreta drop directly into the tank through a pipe submerged in the liquid layer (aqua privy). If the tank is away from the latrine (septic tank), the toilet usually has a U-trap. Neither system disposes of wastes: they only help to separate the solid matter from the liquid. Some of the solids float on the surface, where they are known as scum, while others sink to the bottom

where they are broken down by bacteria to form a deposit called sludge. The liquid effluent flowing out of the tank is as dangerous to health as raw sewage and should be disposed of, normally by soaking it into the ground through a soakaway, or by connecting the tank to sewer systems. The accumulated sludge in the tank must be removed regularly, usually once every 1–5 years, depending on the size of the tank, number of users, and kind of use. If sullage is also collected in the tank, the capacity of both the tank and the liquid effluent disposal system will need to be larger. If the soil has a low permeability, or if the water table is high, it may be necessary to connect the tank to a sewer system, if available.

Every tank must have a ventilation system to allow methane and malodorous gases to escape. The gases are generated by bacteria during sewage decomposition, and methane in particular is highly flammable and potentially explosive if confined in the tank. Septic tanks are more expensive than other on-site sanitation systems and require higher amounts of water. Aqua privies are slightly less expensive and need less water for flushing.

Initial cost: US\$ 90–375 (including labour and materials).

Area of use: In rural or periurban areas where water is available.

Water needed per flush: 2–5 litres, if a pour-flush pan or aqua privy is used.

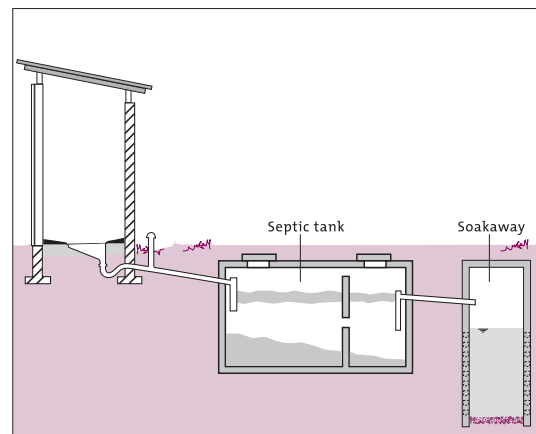

Figure 8.7 Septic tank

¹ Kaplan (1991); Wegelin-Schuringa (1991); Franceys, Pickford & Reed (1992).

8.7.2 Main O&M activities

Regular cleaning of the toilet with normal amounts of soap is unlikely to be harmful, but large amounts of detergents or chemicals may disturb the biochemical processes in the tank. In aqua privies the amount of liquid in the tank should be kept high enough to keep the bottom of the drop pipe at least 75 mm below the liquid level. A bucket of water should be poured down the drop pipe daily to maintain the water seal, and to clear scum from the bottom of the drop pipe, in which flies may breed. Adding some sludge to a new tank will ensure the presence of microorganisms and enhance the anaerobic digestion of the excreta. Routine inspection is necessary to check whether desludging is needed and to ensure that there are no blockages at the inlet or outlet. The tank should be emptied when solids occupy between one-half and two-thirds of the total depth between the water level and the bottom of the tank. Organizational aspects involve providing reliable services for emptying the tanks, ensuring that skilled contractors are available for construction and repairs, and controlling sludge disposal.

8.7.3 Actors and their roles

Actors	Roles	Skills required
User.	Flush the toilet, keep it clean, inspect vents, control contents of the tank, contact municipality or other organization for emptying when necessary, and record dates tank was emptied.	✘
Sanitation service.	Empty the tank, control tank and vents, repair if needed.	✘✘
Agency.	Monitor the performance of the tank and the teams that empty it, train the teams.	✘✘✘

✘ Basic skills. ✘✘ Technical skills. ✘✘✘ Highly qualified.

8.7.4 O&M technical requirements

Activity and frequency	Materials and spare parts	Tools and equipment
Daily		
— clean the squatting pan or seat and shelter.	Water.	Brush, water container.
Monthly		
— inspect the floor, squatting pan or seat, and U-trap.		
Regularly		
— ensure that the entry pipe is still submerged (for aqua privies).	Water.	Stick.
Occasionally		
— unblock the U-trap;	Water.	Flexible brush or other flexible material.
— repair the squatting pan or seat, U-trap or shelter.	Cement, sand, water, nails, local building materials.	Bucket or bowl, trowel, saw, hammer, knife.
Annually		
— control the vents.	Rope or wire, screen materials, pipe parts.	Scissors or wire-cutting tool, pliers, saw.
Every one to five years		
— empty the tank.	Water, fuel, lubricants, etc.	Vacuum tanker (large or mini), or MAPET equipment.

8.7.5 Potential problems

- many problems arise because inadequate consideration is given to liquid effluent disposal;
- large excreta flows entering the tank may disturb solids that have already settled, and temporarily increase the concentration of suspended solids in the effluent;
- if the water seal is not maintained in an aqua privy, the tanks will leak and cause insect and odour problems;
- this system is not suitable for areas where water is scarce, where there are insufficient financial resources to construct the system, or where safe tank emptying cannot be carried out or afforded;
- if there is not enough space for soakaways or drainage fields, small-bore sewers should be installed;
- aqua privies only function properly when they are well designed, constructed and operated;
- septic tank additives (such as yeast, bacteria and enzymes), which are often sold for “digesting scum and sludge” and for “avoiding expensive pumping”, are not effective.

8.8 Vacuum tanker¹

8.8.1 The technology

A vacuum tanker is a motor vehicle, equipped with a vacuum pump and tank, for emptying or desludging pit latrines, septic tanks or sewers, and for hauling sludge to a disposal station. Conventional vacuum tankers (built on a regular 10-ton truck chassis) have a hauling capacity of 4–6 m³ of sludge, and mini tankers (on a small chassis) less than 2 m³.

All vacuum tanker systems use a pump to create a vacuum in the tank and suction hose. The vacuum then lifts the sludge into the tanker. If the bottom layers of sludge are compacted, they can be broken up with a long spade, or jetted with a water hose, before being pumped out. Water hoses (with their own water tanks) are often fitted to the tankers. Some tankers have high-powered vacuum pumps and an air stream into the suction hose that acts as a transport medium for the sludge (“air drag” or “plug and drag” techniques). These tankers can deal with heavy sludge in pit latrines (especially at the bottom where solids have settled out and organic material has broken down). A small amount of sludge should always be left in the pit to ensure that decomposition continues rapidly. Vacuum tankers can be emptied by pressure discharge or by tipping the tank.

Initial cost: the cost of a vacuum tanker can vary enormously and depends on the manufacturer, the condition of the equipment, the country of use, etc. Prices can vary from US\$ 20 000–100 000 or more.

Area of use: Urban or periurban areas with roads (conventional system), or with reasonable access (for mini tankers).

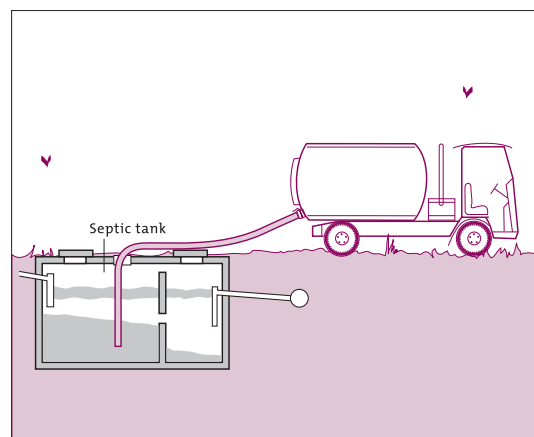

Figure 8.8 Vacuum tanker

¹ Boesch & Schertenleib (1985).

8.8.2 Main O&M activities

Daily checks before work:

- the oil levels in the vacuum pump, oil-cooling tank, hydraulic tank and tanker engine;
- the tanker fuel level;
- the water levels in the tanker engine, the windscreen water bottle, the wash tank, and the water tank for the vacuum pump;
- are all the necessary materials present;
- the cooling radiator for the hydraulic oil and pump oil;
- is the rear door closed and secured.

Daily operation after work:

- drain the sludge and oil separators.

Weekly checks:

- tyre pressures, lights, indicators, horns;
- valves that prevent the tank from being overfilled;
- contacts between gaskets and seats, and performance steel balls;
- leaks in the hydraulic system (tighten couplings), and power take-off shafts (depending on type).

Two-yearly check:

- vacuum pump bearings after 3000 hours or two years.

Chassis and engine:

- carry out regular maintenance according to the service manual, including changing the engine oil, oil filter and fuel filter, and greasing all points;
- change the hydraulic oil, hydraulic filter, and cooling oil;
- clean the cooling-oil filter after one year, or sooner if required.

The vacuum truck service and its O&M are usually organized and executed by a professional organization, normally under the responsibility of the municipality. User fees for the service are usually set officially (and often heavily subsidized), either by the organization or the government. There is very little involvement of the households being served. Management and supervision of the services are often ineffective. In many areas, for example, there are not enough vacuum tankers, which results in poor service.

8.8.3 Actors and their roles

Actors	Roles	Skills required
Truck driver.	Driving the truck, simple checks and maintenance of the truck.	✘
Crew member.	Some maintenance activities, operating the vacuum pump and desludging.	✘
Mechanic.	Major maintenance and repairs.	✘✘
Government or private organization.	Organizing the service, ensuring that the sludge is disposed of hygienically.	✘✘✘

✘ Basic skills. ✘✘ Technical skills. ✘✘✘ Highly qualified.

8.8.4 O&M technical requirements

Activity and frequency	Materials and spare parts	Tools and equipment
Daily, before work		
— check oil levels, water levels, and cooling radiator for the hydraulic oil and pump oil.	Oil, water, oil filters and other simple spare parts for the truck.	Simple tool set for truck maintenance.
Daily, after work		
— drain the sludge and oil separators.		Simple tool set for truck maintenance, bucket.
Daily or more frequently		
— fill in forms, carry out administrative tasks;	Paper.	Pen.
— empty the tank.		
Weekly		
— weekly checks.	Oil, water, grease, oil filters and other simple spare parts for the truck.	Simple tool set for truck maintenance.
Every 1–2 weeks (depending on tanker type)		
— superstructure: clean the vacuum pump, remove and clean washwater filter.	Water, soap.	Brush, bucket.
After one year or when required		
— change the hydraulic oil, hydraulic filter, and cooling oil, and clean the cooling oil filter.	Oil, filters, etc.	Simple tool set for truck maintenance.
According to manual		
— service truck chassis and engine;	Standard and specialized spare parts for trucks.	Simple mechanics' workshop.
— grease the points, clean and grease the safety valves.	Grease.	Simple tool set for truck maintenance.
Occasionally		
— repair the superstructure;	Standard and specialized spare parts for superstructure.	Mechanical workshop tools.
— check vacuum pump bearings.	Grease, water.	Mechanical workshop tools.

8.8.5 Potential problems

- usual vehicle problems;
- the main problems are not primarily due to technical failures, but more to the lack of preventive maintenance, not replacing spare parts, and to the bad state of the roads;
- the final disposal of sludge is often not supervised adequately;
- tankers are not suitable for narrow streets, steep slopes or wherever large vehicles cannot reach the tank or pit;
- many tankers cannot handle the heavy sludge often found in dry latrines.

8.9 Manual pit emptying technology (MAPET)¹

8.9.1 The technology

The Manual Pit Emptying Technology (MAPET) uses manually operated equipment to empty the latrine pit. Its main components are a piston handpump and a 200-litre vacuum tank, both mounted on pushcarts, and connected by a 3/4-inch (2-cm) hosepipe. A 4-inch (10-cm) hosepipe is used to drain the sludge from the pit. When the handpump wheel is rotated air is sucked out of the vacuum tank, which sucks sludge from the pit through the 4-inch hosepipe and into the tank. The effective pumping head is 3 m, depending on the viscosity of the sludge. The sludge is usually buried in a hole close to the pit, or taken to a nearby disposal point (e.g. a disposal field, or sludge transfer station). The equipment is small and hand-operated, and is therefore particularly suitable for high-density settlements with narrow streets, where conventional vacuum tankers have no access. The maximum width of the MAPET, for example, is 0.8 m. Motor-driven vacuum tankers built on small tractors are available, and they use the same principle as the MAPET.

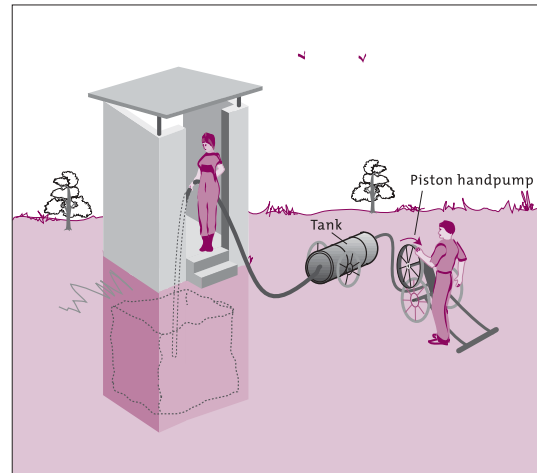

Figure 8.9 MAPET system

The equipment is small and hand-operated, and is therefore particularly suitable for high-density settlements with narrow streets, where conventional vacuum tankers have no access. The maximum width of the MAPET, for example, is 0.8 m. Motor-driven vacuum tankers built on small tractors are available, and they use the same principle as the MAPET.

Initial cost: US\$ 3000 in Dar es Salaam, Tanzania, in 1992 dollars (Muller & Rijnsburger, 1994). The price included the costs of procuring all the parts and materials locally: gas, welding rods, paint, transportation, and labour for assembly.

Area of use: In unplanned and low-income urban areas, especially where access for motor vehicles is poor and where double-pit systems cannot be applied.

Cost of operation: In 1992, US\$ 2.50 per tank load of 200 litres in Dar es Salaam, Tanzania (Muller & Rijnsburger, 1994).

8.9.2 Main O&M activities

The emptying job starts with contacting the customer, negotiating the price, picking up the MAPET equipment from its parking place and taking it to the customer's house (which may take from 30–60 minutes). A hole is dug for sludge disposal and the latrine sludge is prepared for pumping. This preparation entails mixing the sludge with water (to make it more liquid) and paraffin (to reduce the smell). After connecting the hosepipes, the sludge can be pumped. Depending on the viscosity of the sludge and the pumping head, it can take 5–20 minutes to fill up one 200-litre tank with sludge. When a tank is full, the hosepipes are disconnected and the tank is manoeuvred next to the dug hole in its discharge position. The sludge is then discharged into the hole by opening a pressure release valve. After putting the tank back in its original position, it can be used to pump sludge again. This routine is repeated until the required amount of sludge has been taken out of the pit. The equipment is then cleaned and returned to the neighbourhood parking place.

Minor repairs, such as spot welding loose parts and repairing tyre punctures, are carried out in small workshops in the area where the MAPET team operates, and are paid for by the team. Costs reach a maximum of US\$ 25 per month. Larger repairs and special maintenance mainly involve repairing or replacing bearings, valves and guides;

¹ Muller & Rijnsburger (1994).

replacing the piston leather (once a year); and replacing the tyres. The jobs are done by trained mechanics in a specialized workshop.

Although the service can be provided privately, it is more normal for the service to be provided by the local sewerage departments. The responsibilities of a sewerage department include:

- training and licensing the pit emptiers;
- manufacturing the MAPET equipment and providing the specialized maintenance for it;
- monitoring the team's performance and making adjustments in the event of poor functioning, particularly when it concerns public health.

8.9.3 Actors and their roles

Actors	Roles	Skills required
Latrine user/owner.	Contact the MAPET team, negotiate the number of tank loads to be removed, negotiate the cost.	✘
MAPET team.	Empty the pits; stay in contact and negotiate with users; organize, carry out and pay for minor maintenance; and contact the workshop when major repairs are needed.	✘✘
Mechanic.	Carry out the more specialized repairs and maintenance of the equipment.	✘✘
Sewerage department.	Monitor performance of the MAPET team, train the pit emptiers and mechanics, organize transportation, and maintain equipment.	✘✘✘

✘ Basic skills. ✘✘ Technical skills. ✘✘✘ Highly qualified.

8.9.4 O&M technical requirements for MAPET

Activity and frequency	Materials and spare parts	Tools and equipment
Regularly		
— minor repairs, such as tyre punctures or small welding jobs.	Rubber, glue, welding rods, spokes.	Basic bicycle repair equipment, basic welding equipment, bucket.
Occasionally		
— repair or replace handpump parts;	Timber, gas, pipe, water valves.	Basic mechanical workshop tools.
— repair the wheels.	Bearings, tyres.	Basic mechanical workshop tools.
Annually		
— replace the leather cup in the handpump.	Leather cup.	Basic mechanical workshop tools.

8.9.5 Potential problems

- flat tyres, broken metal parts that require welding, wheel bearings that wear out rapidly, a damaged wheel, worn-out pump elements (bearings, valves, pistons), a corroded tank;
- the system is not suitable if the sludge has to be transported more than 0.5 km to the burying site or transfer station;
- transfer stations are only feasible if the municipalities facilitate the secondary collection and treatment of the sludge;
- potential demand for MAPET service is high, but the system needs to be marketed more aggressively.

8.10 Soakaway¹

8.10.1 The technology

A soakaway is a pit for collecting the liquid effluent from a septic tank, which is then allowed to infiltrate the ground. The capacity of the pit should be at least equal to that of the septic tank. The pit may be filled with stones, broken bricks, etc., in which case no lining is needed, or it may be lined with open-jointed masonry (often with a filling of sand or gravel between the lining and the soil to improve infiltration). The top 0.5 m of the pit should be lined solidly, to provide firm support for the reinforced concrete cover. The cover is sometimes buried by 0.2–0.3 m of soil to keep insects out of the pit. The size of the soakaway is determined mainly by the volume of liquid effluents produced, and by local soil conditions. With large effluent flows, drainage trenches may be more economical than soakaways. Planting trees adjacent to, or over, a soakaway can improve both transpiration and permeability.

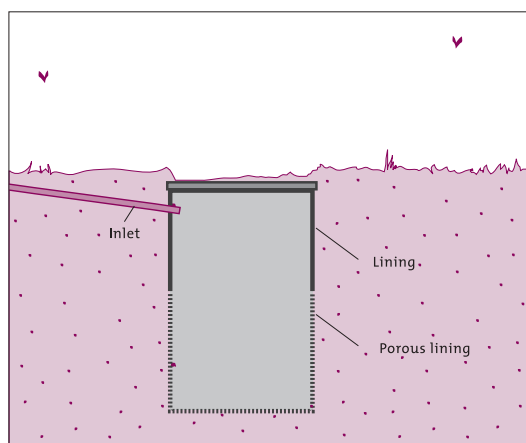

Figure 8.10 Soakaway

Area of use: In rural or periurban areas where sufficient water is available, the soil is permeable, and there is no bedrock or groundwater near the surface.

8.10.2 Main O&M activities

Hardly any activities are required to operate the system, except when the soakaway or septic tank overflows. Then the tank outflow should be cleaned and the delivery pipe unblocked, if necessary.

8.10.3 Actors and their roles

Actor	Roles	Skills required
Householder/user or local caretaker.	Check the outflow tank and performance of the soakaway.	✱
Local artisan.	Repair broken parts, remove obstructions in delivery pipes.	✱✱
Agency department.	Monitor performance of the systems, train users/caretakers and local artisans, provide assistance with big problems.	✱✱✱

✱ Basic skills. ✱✱ Technical skills. ✱✱✱ Highly qualified.

8.10.4 O&M technical requirements

Activity and frequency	Materials and spare parts	Tools and equipment
Once a month		
— check the outflow of the tank boxes and clean them.	Water.	Brush, tools to open the access.
Whenever necessary		
— repair the pipe connection to the soakaway.	Water, materials for dismantling pipes.	Brush, shovel, and tools to open the access, and to dismantle connector pipes.

¹ National Environmental Health Association (1979); Kaplan (1991); Franceys, Pickford & Reed (1992).

8.10.5 Potential problems

- the soakaway overflows – this is a particular problem if both toilet wastes and sullage are collected in the septic tank and the tank was designed for toilet wastes only;
- the system not suitable if there is not enough space or water, or sufficient financial resources for construction, where the soil is not permeable enough or is too hard to dig out (bedrock), or where the groundwater is close to the surface.

8.11 Drainage field¹

8.11.1 The technology

Drainage fields consist of gravel-filled underground trenches, called leachlines or drainage trenches, that allow the liquid effluent from a septic tank to infiltrate the ground. Open-jointed (stone-ware) or perforated (PVC) pipes lead the liquid effluent into the drainage field. Initially, infiltration may be fast, but after several years the soil clogs and an equilibrium infiltration rate is reached. If the sewage flow exceeds the equilibrium rate of the soil, sewage will eventually surface over the drainage field. Pressure can be taken off drainage fields by reducing the amount of water and solids flowing into the solids interceptor tank (e.g. by installing toilets that use less water – “low-flush” toilets), or by preventing sullage from entering the tank

The drainage trenches are usually 0.3–0.5 m wide and 0.6–1.0 m deep (from the top of the pipes). The trenches are laid with a 0.2–0.3% gradient of gravel (20–50 mm diameter), and a 0.3–0.5 m layer of soil on top. A barrier of straw or building paper prevents the soil from washing down. The trenches should be laid in series so that as each trench fills, it overflows to the next one. This ensures that each trench is used either fully, or not at all. The trenches should be 2 m apart, or twice the trench depth if this is greater than 1 m. The bottom of a trench should be at least 0.5–1 m above groundwater, bedrock or impermeable soil, and the slope of the land should not exceed 10%.

An area of land equal in size to the drainage field should be kept in reserve, either to allow the field to be extended in the future, or to allow another drainage field to be dug if the first becomes clogged. Drainage fields are often used instead of soakaways, where larger quantities of liquid effluent are produced.

8.11.2 Main O&M activities

Hardly any activities are required to operate the system, except to watch for field overflows, switching to a second drainage field every 6–12 months, and determining the dates of switching (if applicable). The tank outflow should be cleaned, and checked that it is in good working order (if not, it should be repaired). Sometimes, it may be necessary to unblock the delivery pipe. Diversion boxes should be cleaned from time to time, based on experience from operating the system. Plant growth should be controlled, to prevent roots from entering the pipes or trenches. Minor O&M and book-keeping may be organ-

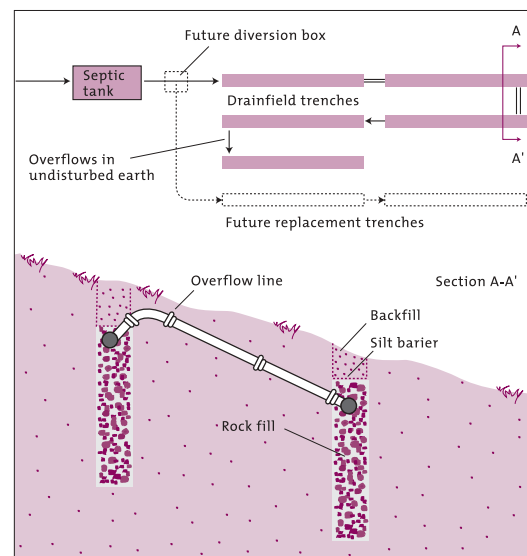

Figure 8.11 Drainage field

¹ National Environmental Health Association (1979); Kaplan (1991); Franceys, Pickford & Reed (1992).

ized and carried out by households, groups of households or the community organization. The responsible government department needs to monitor the performance of drainage fields, and train users, organizations, artisans and caretakers on the technical aspects of their O&M.

8.11.3 Actors and their roles

Actors	Roles	Skills required
Householder/user or local caretaker.	Check the outflow tank and performance of the drainage field, and control plant growth.	✱
Local artisan.	Repair broken parts, remove obstructions in delivery pipes.	✱✱
Agency.	Monitor system performance, train users/caretakers and local artisans in the use of the system, provide assistance with major problems.	✱✱✱

✱ Basic skills. ✱✱ Technical skills. ✱✱✱ Highly qualified.

8.11.4 O&M technical requirements

Activity and frequency	Materials and spare parts	Tools and equipment
Regularly		
— control plant growth.		Shovel, bucket, machete, etc.
Every month		
— clean the diversion boxes.	Water.	Shovel, brush.
Once a month		
— check tank outflow pipe and clean it.	Water.	Brush, tools to open the access hole.
Once every 6–12 months		
— switch to another drainage field.	Bricks or other material to block pipes.	Tools to open the diversion box.
Occasionally		
— unblock the delivery pipe.	Water, piping, glue.	Brush, shovel, long stick or flexible brush, knife, saw.

8.11.5 Potential problems

- overflowing leachlines, unpleasant odours, groundwater contamination and social conflict (over siting of the drainage fields, odours, etc.);
- there is not enough water to use or maintain the system;
- there is not enough space or financial resources for construction;
- the permeability of the soil is poor;
- the bedrock or groundwater are close to the surface;

8.12 Small-bore sewerage system¹

8.12.1 The technology

Small-bore sewerage (or settled sewerage) systems are designed to receive only the liquid fraction of household wastewater. The solid component of the wastewater is kept in an interceptor tank (basically a single-compartment septic tank) and settles out. Periodically, the interceptor tank will need to be desludged. Because small-bore sewers only

¹ Reed (1995); Mara (1996).

receive liquid sewage, they are designed differently from conventional sewers and have the following advantages:

- the system uses less water, since solids do not need to be transported;
- excavation costs are cheaper because the pipes can be laid at shallow depths;
- the sewage flow rates in small-bore pipes do not have to be self-cleansing rates;
- material costs are lower, because the pipe diameter can be small (peak flow is reduced by the interceptor tanks), and there is no need for large manholes;
- there are fewer treatment requirements, because the solids are kept in interceptor tanks.

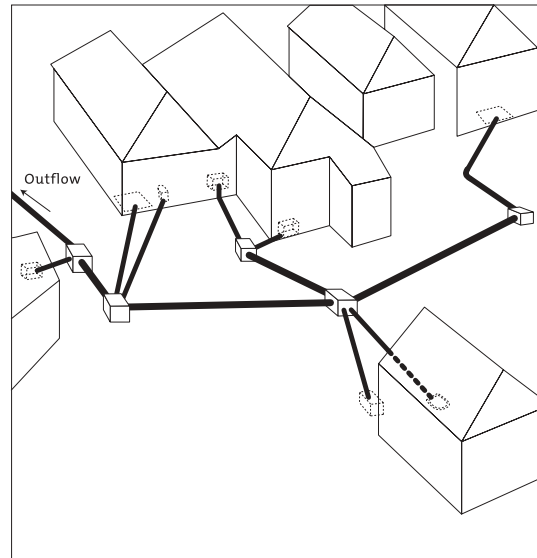

Figure 8.12 Small-bore sewerage system

The small-bore sewer system consists of house connections, an interceptor tank, sewers, cleanouts/ manholes, vents, a sewage treatment plant, and lift stations (where gravity flow is not possible).

The system is most appropriate for areas that already have septic tanks, but where the soil cannot (or can no longer) absorb the effluent, or where the population is too dense and there is no room for soakaways. Small-bore sewerage systems also provide an economical way of upgrading existing sanitation facilities to a level more comparable to conventional sewers.

Initial cost: No recent data were available, but the cost of the system in Brotas (Brazil) was estimated to be 78% cheaper than conventional sewerage; in Australia and USA, the savings on construction costs were 25–35%, but this excluded the cost of the interceptor tanks.

Area of use: In areas where individual soakaways are not appropriate (due to soil conditions or densities), and areas where pour-flush latrines with soakpits can be upgraded to a small-bore sewerage system.

8.12.2 Main O&M activities

The main operational requirements for the household are to ensure that no solids enter the system, and that the interceptor tank functions properly. This should be checked by the local sewerage authority, because the system will be at risk if solids can enter. The sludge in the interceptor tank also needs to be removed regularly, and blockages in the sewage pipes removed. The system will also need to be flushed periodically. The performance of the pipeline system components, such as cleanouts, manholes, lift stations (possibly) and ventilation points should be regularly checked and maintained.

The main organizational activity with the system is to provide desludging services for the interceptor tanks. The principal problems related to desludging revolve around responsibility. Normally this lies with the property owners, since the interceptor tanks are on their property. But residents who are not owners have no incentive to desludge the tanks regularly, since this costs money and is inconvenient, and the overflowing sludge in the sewerage system does not directly affect them (even though it will affect the communal sewerage system downstream). If the sewer system is to work effectively, therefore,

responsibility for tank desludging must fall on the organization responsible for communal sewer maintenance. This organization should also bear responsibility for treating liquids from the sewers.

8.12.3 Actors and their roles

Actors	Roles	Skills required
Householder.	Check household plant and equipment, and help the community organization inspect the tanks and common sewer line.	✘
Local labour/mechanic.	Check on-site plant and equipment, perform small repairs, and remove blockages in the sewer pipes.	✘✘
Community organization.	Organize the regular checking of the community sewer, notify the agency of problems that cannot be solved, and collect sewer charges.	✘
Agency.	Monitor the system's performance; keep regular contacts with community organizations and monitor their performance; train teams and mechanics; organize staff and community members; operate and maintain the collector sewer, pumping station and treatment plant.	✘✘✘

✘ Basic skills. ✘✘ Technical skills. ✘✘✘ Highly qualified.

8.12.4 O&M technical requirements

Activity and frequency	Materials and spare parts	Tools and equipment
Daily/weekly		
— clean the grease trap.		Specialized tools and equipment.
Regularly		
— inspect the street sewers.	Specialized spare parts and materials.	Specialized tools and equipment.
At least annually		
— check the inspection chambers, plant and equipment (pumps, controls, vacuum chamber, surge chamber, and valves).	Water.	Basic mechanical tool set.
When needed		
— repairs and removal of blockages.	Water, specialized materials and spare parts.	Rodding tool, mechanical tool set.

8.12.5 Potential problems

- the interceptor tanks overflow, because they have not been desludged in time;
- the system becomes blocked because of illegal connections that by-pass the interceptor tank;
- small-bore sewerage systems are basically only suitable where there are septic tanks or other on-site systems;
- the need to desludge the interceptor tank regularly requires the involvement of a well-organized sewerage department.

9. Bibliography

Note: The author names of references cited in text are indicated with **bold** font. Other publications listed are relevant to the topics in this manual.

- Acra A, Raffoul Z, Karahagopian Y (1984) *Solar disinfection of drinking-water and oral rehydration solutions: guidelines for household application in developing countries*. Beirut, Illustrated Publications.
- Acra A et al. (1990) *Water disinfection by solar radiation: assessment and application*. Ottawa, International Development Research Centre (Technical Study/IDRC 66c).
- Acrema (1988) *Volanta: pièces de réchange: cahier d'entretien*. Tahoua, Burkina Faso, Acrema.
- An Foras Forbartha, Electricity Supply Board and Alternative Energy Committee (1981) *The development of small-scale hydro-schemes*. Dublin, Department of Industry and Energy.
- Anglade A et al. (1985) *Les énergies de pompage: approvisionnement en eau et énergies renouvelables*. Verberie (France), Institut Technologique Dello (Dossier Technologies et Développement).
- Arlosoroff S et al.** (1987) *Community water supply: the handpump option*. Washington, DC, World Bank.
- Bakalian A et al. (1994) *Simplified sewerage: design guidelines*. Washington, DC, UNDP-World Bank Water and Sanitation Programme (Water and Sanitation Report No. 7).
- Bakhteari QA, Wegelin-Schuringa M** (1992) *From sanitation to development: the case of the Baldia soakpit pilot project*. The Hague, IRC International Water and Sanitation Centre (Technical Paper Series/IRC No. 31).
- Barry MA (1990) *Rapport d'activité sur les expérimentations de pompes à motricité humaine en hydraulique villageoise*. Ouagadougou, Comité Interafricain d'Etudes Hydrauliques (Série Hydraulique villageoise).
- Barry MA (1990) Evaluation de trente hydropompes Vergnet dans la province Yatenga (Burkina Faso). *Bulletin de Liaison du Comité Interafricain d'Etudes Hydrauliques*, 79:29–33.
- Bastemeyer T, Visscher JT (1987) *Maintenance systems for rural water supplies*. The Hague, IRC International Water and Sanitation Centre (Occasional Paper Series/IRC No. 8).
- Baumann E** (1993a) *Choice of technology: a paper prepared for a CWS project in Ghana*. St. Gallen, Swiss Centre for Development Cooperation in Technology and Management.
- Baumann E** (1993b) *Performance evaluation of handpumps used in UNICEF projects (Draft)*. St Gallen, Swiss Centre for Development Cooperation in Technology and Management.
- Baumann E (2000) *Water lifting*. St. Gallen, Swiss Centre for Development Cooperation in Technology and Management (SKAT Manuals on Drinking-Water Supply, Volume 7).
- Besselink J (1990) *Problèmes techniques de la pompe Volanta à Dosso, Niger: inventarisation et analyse, causes et remèdes: rapport de la mission d'appui au PHV/DDH Dosso Niger du 6.05.90 au 8.07.90*. Arnhem, Netherlands, Interaction Design.
- Besselink J, van Wilgenburg F (1992) *Small-scale drinking-water supply systems for deep wells: two desk studies of aspects of deep well handpumps and alternative small-scale mechanical drinking-water supply systems*. The Hague, Section for Research and Technology, Directorate-General for Development Cooperation, Ministry of Foreign Affairs.
- Bielenberg C, Hugh A (1995) *How to make and use the treadle irrigation pump*. London, Intermediate Technology Publications, 1995.
- Blair Research Laboratory (1988) *Bucket pump manual for field workers*. Harare, Zimbabwe.
- Blair Research Laboratory (1991) *The Zimbabwe Bush pump: a manual for the installation, dismantling and maintenance of the "B" type Bush pump*. Harare, Zimbabwe.

- Boesch A, Schertenleib R** (1985) *Emptying on-site excreta disposal systems: field tests with mechanized equipment in Gaborone (Botswana)*. Duebendorf (Switzerland), International Reference Centre for Waste Disposal (IRCWD Report No. 03/85).
- Boesveld M (1988) *The Public Standpost Water Supplies Project in Indonesia: an overview with special emphasis on the methodology applied at the local demonstration schemes*. Bandung (Indonesia), Institute of Human Settlements.
- Brand A, Bradford B (1991) *Rainwater harvesting and water use in the barrios of Tegucigalpa*. Tegucigalpa (Honduras), UNICEF.
- Brandberg B (1997) *Latrine building: a handbook to implementing the Sanplat system*. London, Intermediate Technology Publications.
- Bridger GA (1988) *Rural water supply*. Ratmalana (Sri Lanka), National Water Supply and Drainage Board (Design Manual, No. D1).
- Bridger GA (1989) *Urban water supply and sanitation*. Ratmalana (Sri Lanka), National Water Supply and Drainage Board (Design Manual, No. D2).
- Brikké F (2000) *Training Course Package in Management of Operation and Maintenance of Rural Water Supply and Sanitation*. Delft, IRC International Water and Sanitation Centre, and Geneva, World Health Organization.
- Brikké F, Rojas J** (2001) *Seven key principles for sustainable cost recovery, in the context of community water supply*. Delft, IRC International Water and Sanitation Centre (draft of an occasional paper).
- Brush RE (1979) *Well construction: hand dug and hand drilled*. Washington, DC, US Peace Corps (Appropriate Technologies for Development).
- Cairncross S, Feachem RG (1993) *Environmental health engineering in the tropics: an introductory text, 2nd edition*. Chichester, Wiley.
- Carlsson B, Drake E** (1990) *Handbook for village water supply operators*. Gaborone (Botswana), Unified Local Government Service, Ministry of Local Government and Lands Centre.
- Carty D** (1990) Water-well bucket protection in Zambia. *Waterlines*, 8(4):26–28.
- Castilla Ruiz A, Galvis Castano G** (1993) *Bombas y estaciones de bombeo. [Pumps and pump stations]*. Cali, CINARA.
- Chimbunde E, Mtero S (1991) Zimbabwe's upgraded well programme. In: Pickford J, ed. *Infrastructure, environment, water and people: proceedings of the 17th WEDC Conference, United Nations Centre for Human Settlements (Habitat), Nairobi, Kenya, 19–23 August 1991*. Loughborough, Water, Engineering and Development Centre (WEDC), Loughborough University of Technology, pp. 111–113.
- CIEH et Fondation de l'Eau** (1990) *Les pompes à motricité humaine: principes, critères de choix, fiches de produits*. Limoges (France), Fondation de l'Eau (Les Cahiers Techniques, No. 13).
- CIEH et BURGEAP (1991) *Etude du vieillissement des forages d'hydraulique villageoise et semi-urbaine en zone de socle cristallin*. Ouagadougou, Comité Interafricain d'Etudes Hydrauliques (Série hydrogéologie).
- Clark L (1992) *The field guide to water wells and bore holes*. London, Intermediate Technology Publications.
- Cotton A, Jansens J (1994) *Tools for the assessment of operation and maintenance status of urban and rural water supply and sanitation*. Geneva, World Health Organization, Operation and Maintenance Working Group.
- Cotton A et al. (1993) *Development of tools for the assessment of operation and maintenance status of water supplies in lesser and least developing countries (draft)*. Geneva, World Health Organization.
- Craun GF (1993) *Safety of water disinfection: balancing chemical and microbial risks*. Washington, DC, ILSI Press.
- Cumberlege OR, Kiongo JM** (1994) A community approach to building rainwater cisterns. In: Bambrah GK, Otieno FO, Thomas DB, eds. *Participation in rainwater collection for low-income communities and sustainable development: proceedings of the sixth International Conference on Rainwater Catchment Systems, 1–6 August 1993*. Nairobi, International Rainwater Catchment Systems Association, pp. 351–357.
- Dahi E (1990) *Environmental engineering in developing countries: a textbook*. Lyngby (Denmark), Polyteknisk Forlag.
- Debris T, Collignon B** (1994) *Entrepreneurs puisatiers du Sahel: la promotion des artisans et des petites entreprises du secteur hydraulique*. Paris, Association Française des Volontaires du Progrès, Ministère de la Coopération.

- Delmas G, Courvallet M (1994) *Public health engineering in emergency situation: a handbook for implementing health programmes in deprived environments, in particular in camps of displaced persons*. Paris, Médecins sans Frontières.
- Derrick A, Francis C, Bokalders V** (1991) *Solar photovoltaic products: a guide for development workers (revised edition)*. London, Intermediate Technology Publications.
- de Vries ET, Berkhuizen JC (1989) *Waterkracht in ontwikkelingslanden: basisrapport*. Rotterdam, Institute for Communication and Advice on Energy and Environment.
- de Vries ET, Berkhuizen JC (1989) *Hydropower in developing countries*. Rotterdam, Institute for Communication and Advice on Energy and Environment.
- Diluca C (1983) *L'hydraulique villageoise dans les pays membres du CILSS: conditions d'utilisation et d'entretien des moyens d'exhaure*. Ouagadougou, Comité Interafricain d'études hydrauliques.
- Ellis KV (1991) 'Water disinfection: a review with some consideration of the requirements of the Third World. *Critical Reviews in Environmental Control*, 20(5/6):341–407.
- Elson B, Shaw R (1995) Simple drilling methods. *Waterlines*, 13(3):16–18.
- Erskine JM** (1991) Rain water harvesting systems in Southern Africa. In: Show-Chyuan Chu, ed. *Rainwater catchment for future generations: proceedings of the fifth International Conference in Rain Water Cistern Systems, Keelung, Taiwan, 4–10 August 1991*. Keelung, National Taiwan Ocean University, pp. 574–585.
- Esrey SA et al (1988) *Ecological sanitation*. Stockholm, Swedish International Development Authority (SIDA).
- Farley M (1995) *Training course package on leakage control*. Geneva, World Health Organization, Operation and Maintenance Working Group.
- Fernando V, De Mel JH (1991) *Non-governmental organisations (NGOs) in Sri Lanka: an introduction*. Colombo, NGO Water Supply and Sanitation Decade Service.
- Folkard GK, Sutherland JP, Shaw R (1999) Water clarification using Moringa oleifera seed coagulant (Technical Brief, No. 60). *Waterlines*, 17(4):15–18.
- Fondation de l'Eau** (1985) *Les pompes centrifuges: entretien et maintenance*. Limoges, Fondation de l'Eau (Les Cahiers Technique, No. 1).
- Fondation de l'Eau (1989) *La chloration des eaux: principe, exploitation et maintenance des installations*. Limoges, SEDA (Les Cahiers Techniques, No. 10).
- Fonseka J, Baumann E** (1994) *Evaluation of maintenance systems in Ghana*. St. Gallen, Swiss Centre for Development Cooperation in Technology and Management (SKAT).
- Fraenkel P** (1986) *Water-pumping devices: a handbook for users and choosers*. London, Intermediate Technology Publications.
- Franceys R (1986) *Twelfth WEDC Conference: water and sanitation at mid-decade*. Loughborough, Water, Engineering and Development Centre (WEDC), Loughborough University of Technology.
- Franceys R, Pickford J, Reed R** (1992) *A guide to the development of on-site sanitation*. Geneva, World Health Organization.
- Galvis G et al.** (1993) *Pre-treatment alternatives for drinking-water supply systems: selection, design, operation and maintenance*. The Hague, IRC International Water and Sanitation Centre (Occasional Paper Series, No. 22).
- Garvey G, Kiros G, Yegletu A (1991) Hand dug wells: field experience from Ethiopia. In: Pickford J, ed. *Infrastructure, environment, water and people: proceedings of the 17th WEDC Conference, United Nations Centre for Human Settlements (Habitat), Nairobi, 19–23 August 1991*. Loughborough, Water, Engineering and Development Centre (WEDC), Loughborough University of Technology, pp. 181–184.
- Gilman RH, Skillicorn P** (1985) Boiling of drinking-water: can a fuel-scare community afford it? *Bulletin of the World Health Organization*, 63(1):157–163.
- Goetsch O (1989) *Evaluation of water supply systems, constructed from 1964 to 1989*. Yaoundé, CD/Helvetas.
- Goetsch O (1989) *Evaluation of water points and wells, constructed from 1964 to 1989*. Yaoundé, CD/Helvetas.
- Gould JE (1991) *Rainwater catchment systems for household water supply*. Bangkok, Environmental Sanitation Information Center, Asian Institute of Technology (Environmental Sanitation Reviews, No. 32).

- Graham NJD (1988) *Slow sand filtration: recent developments in water treatment technology*. Chichester, Ellis Horwood (Ellis Horwood series in Water and Wastewater Technology).
- Groundwater Survey (1989). *Inventory of well-siting methods: final report. Revised edition*. Nairobi, Kenya, Groundwater Survey (Well-siting for low-cost water supplies, vol. 1).
- Hailu S (1988) *Applicability of small-bore gravity sewers in Addis Ababa, Ethiopia*. Tampere (Finland), Tampere University of Technology (Publication Series B, No. 31).
- Harris D (1992) *Disinfection for rural community water supply systems in developing countries*. Arlington, VA, Water and Sanitation for Health Project.
- Harvey A et al. (1993) *Micro-hydro design manuals: a guide to small-scale water power schemes*. London, Intermediate Technology Publications.
- Hasse R** (1989) *Rainwater reservoirs above ground structures for roof catchment: most common rainwater tanks in comparison and construction manual*. Braunschweig, Vieweg.
- Hodgkin J et al. (1991) *Meeting rural pumping needs in Sudan: an analysis of pumping system choice (diesel, wind, or solar)*. Burlington, VT, Associates in Rural Development.
- Hofkes EH (1983) *Handpump maintenance: guidelines for organising handpump maintenance systems*. The Hague, IRC International Water and Sanitation Centre.
- Hofkes EH, Visscher JT** (1986) *Renewable energy sources for rural water supply*. The Hague, IRC International Water and Sanitation Centre (Technical Paper Series, No. 23).
- Hofkes EH et al. (1983) *Small community water supplies: technology of small water supply systems in developing countries. Enlarged edition*. The Hague, IRC International Water and Sanitation Centre (Technical Paper Series, No. 18).
- Inversin AR (1986) *Micro-hydropower sourcebook: a practical guide to design and implementation in developing countries*. Washington, DC, NRECA International Foundation.
- IRC (1982) *Rural water supply development: the Buba-Tombali water project: 1978–1981*. The Hague, IRC International Water and Sanitation Centre.
- IRC (1983) *Water supply for small communities*. Delft, IRC International Water and Sanitation Centre (Technical Paper Series, No. 18).
- IRC** (1993) *Taking care of your water supply: a manual for community-based operation and maintenance of piped water systems*. The Hague, IRC International Water and Sanitation Centre (Training Series, No. 10).
- IRC, DGIS (1986) *Pompe à main Volanta: instructions d'entretien*. The Hague, IRC International Water and Sanitation Centre.
- IRC, IDRC (1988) *Handpumps: issues and concepts in rural water supply programmes*. The Hague, IRC International Water and Sanitation Centre (Technical Paper Series, No. 25).
- IRC, WHO** (2000) *Management of operation and maintenance of rural water and sanitation programmes – a training package for managers and planners*. Geneva, World Health Organization.
- Isely RB (1983) *Evaluation of health and social benefits of springs capped for irrigation, further adapted for domestic use in central Tunisia*. Arlington, VA, Water and Sanitation for Health Project (WASH Field Report, No. 84).
- Jeffcoate P, Pond R** (1989) *Large water meters: guidelines for selection, testing, and maintenance*. Washington DC, World Bank (World Bank Technical Paper, No. 111).
- Jeffrey TD et al. (1992) *Hydraulic ram pumps: a guide to ram pump water supply systems*. London, Intermediate Technology Publications.
- Jigabha J (1992) *Water metering development in Dar es Salaam, Tanzania*. Tampere, Institute of Water and Environmental Engineering, Tampere University of Technology (Publication Series B, No. 52).
- Johansen SS et al. (1983) *Water operators handbook: Mongu Training Centre, Western Province, Zambia*. Lusaka, Zambia Department of Water Affairs.
- Jordan TD** (1984) *A handbook of gravity-flow water systems for small communities*. London, Intermediate Technology Publications.
- Jordan JK, Buijs P, Wyatt AS (1986) *Assessment of the operations and maintenance component of water supply projects*. Arlington, VA, Water and Sanitation for Health Project (WASH Technical Report, No. 35).
- Kaplan OB** (1991) *Septic systems handbook, 2nd ed.* Chelsea, MI, Lewis.
- Kern C (1989) *Community water development*. London, Intermediate Technology Publications.

- Kurian T, El Mowaffi S, Mullick MA (1984) *Installation, operation and maintenance manual for vertical turbine pumps, submersible pumps, horizontal pumps, and diesel engines*. Sanaa, Rural Water Supply Department.
- KWAHO (1988) *The Afridev handpump: scheduled maintenance, No. 1*. Nairobi, KWAHO.
- Lambert R (1990) *How to make a rope-and-washer pump*. London, Intermediate Technology Publications.
- Lammerink M et al.** (1995) *Evaluation report: Nicaraguan experiences with the rope pump*. The Hague, IRC International Water and Sanitation Centre.
- Lancashire S, Kenna J, Fraenkel P (1987) *Windpumping handbook*. London, Intermediate Technology Publications.
- Lauterjung H, Schmidt G** (1989) *Planning of intake structures*. Braunschweig, Vieweg.
- Laver S (1985) *Handbook for the protection of village water supplies in Zimbabwe*. Harare, University of Zimbabwe.
- Laver S (1986) *Raising water with different pumps: the Zimbabwe bucket pump*. Harare, Blair Research Laboratory (Pump Handout, No. 1).
- Laver S (1986) *Raising water with different pumps: the Zimbabwe Blair pump*. Harare, Blair Research Laboratory (Pump Handout, No. 2).
- Lee MD, Bastemeijer TF (1991) *Drinking-water source protection: a review of environmental factors affecting community water supplies*. The Hague, IRC International Water and Sanitation Centre (Occasional Paper Series, No. 15).
- Lee MD, Visscher JT** (1990) *Water harvesting in five African countries*. The Hague, IRC International Water and Sanitation Centre (Occasional Paper Series, No. 14).
- Lee MD, Visscher JT** (1992) *Water harvesting: a guide for planners and project managers*. The Hague, IRC International Water and Sanitation Centre (Technical Paper Series, No. 30).
- Lovejoy D (1985) Technical note on comparative costs of solar, wind and diesel pumping at village sites in Nigeria and Somalia. *Natural Resources Forum*, 9(1):77–80.
- Luff R, Hoque E (1997) Disinfecting tube-well water: the evolution of a new technology. *Waterlines*, 16(2): 30–32.
- Manus Coffey Associates (1994) *Proposal for low-cost mechanised latrine emptying system*. Dublin, Manus Coffey Associates.
- Mara DD** (1984) *The design of ventilated improved pit latrines*. Washington, DC, World Bank (TAG Technical Note, No. 13).
- Mara DD (1996) *Low-cost urban sanitation*. Chichester, Wiley.
- Marseille M et al. (1989) *Qualidade de água e uso de água, e situação de diarreia, na aldeia de Macharote, distrito de Dondo. [Water quality and usage and the diarrhoea situation in the village of Macharote, Dondo district]*. Beira (Mozambique), Centro Regional de Higiene Ambiental (CRHA), Direção Provincial de Saúde de Sofala.
- Marshall K (1982) *Evaluation of water current turbines in Southern Sudan*. Rugby, United Kingdom, Intermediate Technology Development Group.
- Mathewson I** (1993) The rebirth of the hydraulic ram pump. *Waterlines*, 12(2):10–14.
- Mayo AW** (1991) Experience in rainwater harvesting in Tanzania. In: Show-Chyuan Chu, ed. *Rain-water catchment for future generations: proceedings of the 5th International Conference on Rain Water Cistern Systems, Keelung, Taiwan, 4–10 August 1991*. Keelung, National Taiwan Ocean University, pp. 535–546.
- McGowan R, Ashworth J (1984) *Comparative testing for water pumping systems installed in Botswana: general research methodology and specific field implementation instructions*. Burlington, VT, Rural Development Inc.
- McGowan R, Hodgkin J** (1992) *Pump selection: a field guide for energy efficient and cost-effective water pumping systems for developing countries. Revised edition*. Arlington, VA, Water and Sanitation for Health Project (WASH Technical Report, No. 61).
- McPherson HJ (1990) *Proceedings of the Meeting of the Operation and Maintenance Working Group, Geneva, 19–22 June 1990*. Geneva, World Health Organization, Community Water Supply and Sanitation Unit.
- McPherson HJ (1994) *Selected case studies on operation and maintenance of water supply and sanitation systems*. Geneva, World Health Organization, Operation and Maintenance Working Group.

- McPherson HJ, McGarry MG (1987) User participation and implementation strategies in water and sanitation projects. *International Journal of Water Resources Development*, 3(1):23–30.
- Meier U** (1990) *Hydram information package: a selected and annotated bibliography on hydraulic ram pumps, including a list of manufacturers, a database printout on Hydram research and selected articles*. St. Gallen, SKAT (Working Paper, No. 1).
- Middleton RN (1995) Making VIP latrines succeed. *Waterlines*, 13(4):27–29.
- Milkov J (1987) *Safe windlass shallow well: construction guide*. Monrovia, Liberia, World Health Organization.
- Ministère de l'Hydraulique et de l'Environnement (1990) *Programme d'hydraulique villageoise, Département de Dosso: formation comités de gestion pompes Volanta – Dogon Doutchi*. Dosso (Niger).
- Mohamed B (1989) *Rapport d'activités sur les expérimentations de pompes à motricité humaine en hydraulique villageoise*. Ouagadougou, CIEH.
- Morgan P** (1990) *Rural water supplies and sanitation*. London, Macmillan.
- Morgan P (1992) *Upgraded well manual for field workers*. Harare, Blair Research Laboratory.
- Mueller AM (1983) *Farm economics of water lifting windmills: a guideline on economic and financial analysis for feasibility studies*. Amersfoort (Netherlands), Consultancy Services for Wind Energy in Developing Countries (Publication CWD, 84-1).
- Muller M, Rijnsburger J** (1994) *MAPET manual pit-latrines emptying technology project: development and pilot implementation of a neighbourhood-based pit-emptying service with locally manufactured handpump equipment in Dar es Salaam, Tanzania, 1998–1992: final report*. Gouda (Netherlands), WASTE Consultants.
- National Environmental Health Association** (1979) *State of the art manual of on-site wastewater management*. Denver, CO, National Environmental Health Association.
- NEERI (1987) *Report on water quality assessment: Ramanathapuram district (Tamil Nadu, India)*. Nagpur, National Environmental Engineering Research Institute.
- NEERI, IRC (1989) *Slow sand filtration: phase IV final report*. Nagpur, National Environmental Engineering Research Institute.
- Neway A** (1992) *Solar energy in water pumping and its economics*. Tampere, Institute of Water and Environmental Engineering, Tampere University of Technology (Publication Series B, No. 50).
- Nilsson A** (1988) *Groundwater dams for small-scale water supply*. Revised edition. London, Intermediate Technology Publications.
- Nutbeam D, Aar L, Catford J (1989) Understanding children's health behaviour: the implications for health promotion for young people. *Social Science and Medicine*, 29(3):317–325.
- Nyangeri EEN** (1986) *Rehabilitation of hand-dug wells and protected springs in Kisil, Kenya*. Tampere, Tampere University of Technology (Water Supply and Sanitation Publications, No. 29).
- Omwenga JM. *Rainwater harvesting for domestic water supply in Kisil, Kenya*. Tampere, Tampere University of Technology, 1984 (Water Supply and Sanitation Publications, No. 17).
- Orr A, Nazrul Islam ASM, Barnes C (1991) *The treadle pump: manual irrigation for small farmers in Bangladesh*. Dhaka, Rangpur Dinajpur Rural Service.
- Otis RJ, Mara DD (1985) *The design of small-bore sewer systems*. Washington DC, World Bank (TAG Technical Note, No. 14).
- Pacey A (1980) *Hand pump maintenance in the context of community well projects*. London, Intermediate Technology Publications.
- Pacey A, Cullis A** (1986) *Rainwater harvesting: the collection of rainfall and runoff in rural areas*. London, Intermediate Technology Publications.
- Parr J, Smith M, Shaw R** (1995) Chlorination of community water supplies. *Waterlines*, 14(2):15–18 (Technical Brief, No. 46).
- Pickford J (1991) *Infrastructure, environment, water and people: proceedings of the 17th WEDC Conference, United Nations Centre for Human Settlement (Habitat), Nairobi, 19–23 August 1991*. Loughborough, Water, Engineering and Development Centre (WEDC), Loughborough University of Technology.
- Pickford J (1995) *Low-cost sanitation: a survey of practical experience*. London, Intermediate Technology Publications.
- Pickford J, Shaw R** (1997) Emptying latrine pits. *Waterlines*, 16(2):15–18 (Technical Brief, No. 54).
- Pieck C (1983) *Opvang en opslag van regenwater. [Rainwater catchment and storage]*. Amsterdam, TOOL.
- Pieck C (1985) *Catchment and storage of rainwater*. Amsterdam, TOOL.

- Pollak F** (1988) *Pump users handbook*. Morden, England, Trade & Technical Press.
- Rahman MM, O'Neill IC, Lawson JD (1989) Common effluent drainage system: an alternative in the wastewater management options for smaller communities. *Asian Environment*, 11(2):7–18.
- Reed RA** (1995) *Sustainable sewerage: guidelines for community schemes*. London, ITDG Publishing.
- Reynolds J** (1992) *Handpumps: toward a sustainable technology: research and development during the Water Supply and Sanitation Decade*. Washington DC, World Bank, Water and Sanitation Division (Water and Sanitation Report, No. 5).
- Rienstra K** (1990) Het voetpad naar de bron: de strijd voor het behoud van land en water. [The footpath to the source: the struggle for conservation of land and water in Nepal]. *Internationale Samenwerking*, 5(1):22–23.
- Roark P (1992) *Management models for the operation and maintenance of rural water supply and sanitation facilities*. Arlington, VA, Water and Sanitation for Health Project (WASH Technical Paper, No. 71).
- Roark P, Tomaro J (1990) *Internal evaluation of USAID assistance to the rural water supply and sanitation sector in Zaire*. Arlington, VA, Water and Sanitation for Health Project (WASH Field Report, No. 313).
- Roark P, Hodgkin J, Wyatt A** (1993) *Models of management systems for the operation and maintenance of rural water supply and sanitation facilities*. Arlington, VA, Water and Sanitation for Health Project (WASH Technical Report, No. 71).
- Sandiford P et al (1993) The Nicaraguan rope pump. *Waterlines*, 11(3):27–30.
- SATEC Développement, CIEH (1985) *Etablissement d'un modèle de gestion de stations de pompage sur forages motorisés*. Ouagadougou, CIEH (Serie Hydrogéologie).
- Sethaputra C (1984) *Collection and storage of roof runoff for drinking purposes*. Khon Khaen (Thailand), Faculty of Education, Khon Khaen University (Socioeconomic Studies, Vol. 4).
- Shaw R (1999) *Running water: more technical briefs for health, water and sanitation*. London, Intermediate Technology Publications.
- Skoda JD, Reynolds C** (1994) Rainwater catchment systems in South Pacific islands: experience of project implementation. In: Bambrak GK, Otieno FO, Thomas DB, eds. *Participation in rainwater collection for low-income communities and sustainable development: proceedings of the Sixth International Conference on Rainwater Catchment Systems, 1–6 August 1993*. Nairobi, International Rainwater Catchment Systems Association, pp. 317–326.
- Skinner B, Shaw R** (1998) Household water treatment: 1. *Waterlines*, 17(2):15–18 (Technical Brief, No. 58).
- Skinner B, Shaw R (1999) Household water treatment: 2. *Waterlines*, 17(3):15–18 (Technical Brief, No. 59).
- Smet J et al.** (1988) *Community self-improvement in water supply and sanitation: a training and reference manual for community health workers, community development workers and other community-based workers*. The Hague, IRC International Water and Sanitation Centre (Training Series, No. 5).
- Tiemersma JJ, Heeren NA (1984) *Small-scale hydropower technologies: an overall view of hydropower technologies for small-scale appliances*. Amsterdam, TOOL/CAT.
- Tiridiri R (1984) *Taking care of our springs: community participation in water supply and sanitation*. Kampala, Ministry of Health (Educational Series, No. 1).
- Turner JH (1987) *Small engines: operation, maintenance and repair*. Blue Ridge Summit, PA, TAB Books.
- UNCHS (1986) *The design of shallow sewer systems*. Nairobi, United Nations Centre for Human Settlements.
- UNDP/IAPSO** (1995) *Emergency relief items: compendium of generic specifications (Draft)*. Copenhagen, United Nations Development Programme/Inter-Agency Procurement Services Office.
- UNEP (1983) *Rain and stormwater harvesting in rural areas: a report*. Dublin, Tycooly (Water Resources Series, Vol. 5).
- UNICEF (1993) *India Mark II handpump: installation and maintenance manual*. New Delhi, UNICEF.
- UNICEF (1993) *India Mark III (VLOM) deepwell handpump: installation and maintenance manual*. New Delhi, UNICEF.
- USAID** (1982) *Evaluating rainfall catchments*. Washington DC, US Agency for International Development (Water for the World Technical Note, No. RWS.1.P.5).
- van de Korput J, Langendijk M** (1993) *The pour flush latrine for guests only? A sociocultural perspective on the pour flush latrine in Chitral*. Gilgit (Pakistan), Aga Khan Health Service (Issue Paper 3).

- van Hemert B van et al.** (1992) *The rope pump: the challenge of popular technology*. Juigalpa (Nicaragua), Dirección de Acueductos Rurales.
- van Meel J, Smulders P** (1989) *Wind pumping: a handbook*. Washington DC, World Bank (World Bank Technical Paper, No. 101).
- van Wijk-Sijbesma C** (1987) *What price water? User participation in paying for community-based water supply with particular emphasis on piped systems*. The Hague, IRC International Water and Sanitation Centre (Occasional Paper Series, No. 10).
- van Winden J** (1990) *Rural Mechanics Course 3: maintenance and repair of stationary diesel engines*. Amsterdam, TOOL.
- Verhaegh M (1990) *Water, the spring of life: a research on the quality of drinking-water in the Mantsonyane area*. Maastricht, University of Maastricht.
- Vigneswaran S, Bhattarai KK, Sharma Tiwari R (1989) *Small community water supply: an illustrative manual*. Bangkok, Asian Institute of Technology, Environmental Engineering Division.
- Visscher JT, Veenstra S (1990) *Slow sand filtration: guide for training of caretakers*. The Hague, IRC International Water and Sanitation Centre (Training Series, No. 6).
- Visscher JT et al** (1987) *Slow sand filtration for community water supply: planning, design, construction, operation and maintenance*. The Hague, IRC International Water and Sanitation Centre (Technical Paper Series, No. 24).
- Waller DH (1989) Rain water: an alternative source in developing and developed countries. *Water International*, 14(1):27–36.
- Water Pollution Control Federation. *Alternative sewer systems*. Alexandria, VA, Water Pollution Control Federation (Manual of Practice, No. FD-12).
- Water Research Centre, WHO Regional Office for Europe** (1989) *Disinfection of rural and small-community water supplies: a manual for design and operation*. Medmenham, Water Research Centre.
- Watt S (1984) *Septic tanks and aquaprivies from ferrocement*. London, Intermediate Technology Publications.
- WEDC** (1991) *The worth of water: technical briefs on health, water and sanitation*. London, Intermediate Technology Publications.
- Wegelin-Schuringa M** (1991) *On-site sanitation: building on local practice*. The Hague, IRC International Water and Sanitation Centre (Occasional Paper Series, 16).
- Wegelin-Schuringa M** (1993) *Operation and maintenance of sanitation systems in urban low-income areas in India and Thailand: final report*. The Hague, Ministry of Foreign Affairs, Directorate-General for Development Cooperation.
- Wegelin M, Sommer B** (1998) Solar water disinfection (SODIS) – destined for worldwide use? *Waterlines*, 16(3):30–32.
- White GC** (1986) *The handbook of chlorination*, 2nd ed. New York, Van Nostrand Reinhold.
- WHO (1988) *Guidelines for cholera control*. Geneva, World Health Organization.
- WHO (1994) *Guidelines for the management of operation and maintenance of urban water supply and sanitation systems*. Geneva, World Health Organization.
- Wilson H (1988) *Costs and financing of water supply and sanitation activities*. New York, UNICEF Water and Environmental Sanitation Team.
- Winblad U, Kilama W** (1985) *Sanitation without water*. Revised edition. Basingstoke, Macmillan (Macmillan Education).
- Wolters H, Visscher JT** (1989) *Slow sand filtration: a simple and reliable method to purify drinking-water*. The Hague, IRC International Water and Sanitation Centre.
- Wood M (1993) A handpump for Africa: the Afridev experience. *Waterlines*, 11(4):29–31.
- Wray A (1989) *Water, engineering and development in Africa: proceedings of the 15th WEDC Conference, Kano, Nigeria, 3–7 April 1989*. Loughborough, WEDC, Loughborough University of Technology.
- Wurzel P, de Rooy C** (1993) Boreholes versus handpumps: addressing a mismatch. *Waterfront*, 3(6–7):20–21.
- Yaziz MI, Din O (1988) Portable slow sand filter performance. In: *Proceedings of the 14th WEDC Conference: water and urban services in Asia and the Pacific, Kuala Lumpur, 11–15 April 1988*. Loughborough, WEDC, Loughborough University of Technology, pp. 19–22.

WHO Library Cataloguing-in-Publication Data

Linking technology choice with operation and maintenance in the context of community water supply and sanitation: a reference document for planners and project staff / prepared by François Brikké and Maarten Bredero.

1. Water supply 2. Sanitation 3. Water resources development 4. Appropriate technology
5. Maintenance – methods 6. Manuals I. Brikké, François II. Bredero, Maarten III. Water Supply and Sanitation Collaborative Council. Operation and Maintenance Network.

ISBN 92 4 156215 3

(NLM classification: WA 675)

© World Health Organization 2003

All rights reserved. Publications of the World Health Organization can be obtained from Marketing and Dissemination, World Health Organization, 20 Avenue Appia, 1211 Geneva 27, Switzerland (tel: +41 22 791 2476; fax: +41 22 791 4857; email: bookorders@who.int). Requests for permission to reproduce or translate WHO publications – whether for sale or for noncommercial distribution – should be addressed to Publications, at the above address (fax: +41 22 791 4806; email: permissions@who.int).

The designations employed and the presentation of the material in this publication do not imply the expression of any opinion whatsoever on the part of the World Health Organization concerning the legal status of any country, territory, city or area or of its authorities, or concerning the delimitation of its frontiers or boundaries. Dotted lines on maps represent approximate border lines for which there may not yet be full agreement.

The mention of specific companies or of certain manufacturers' products does not imply that they are endorsed or recommended by the World Health Organization in preference to others of a similar nature that are not mentioned. Errors and omissions excepted, the names of proprietary products are distinguished by initial capital letters.

The World Health Organization does not warrant that the information contained in this publication is complete and correct and shall not be liable for any damages incurred as a result of its use.

Designed by minimum graphics
Printed in Malta