

DESIGN, SIZING, CONSTRUCTION AND MAINTENANCE OF GRAVITY-FED SYSTEM IN RURAL AREAS

MODULE 1: GENERAL INFORMATION ON WATER AND WATER SUPPLY

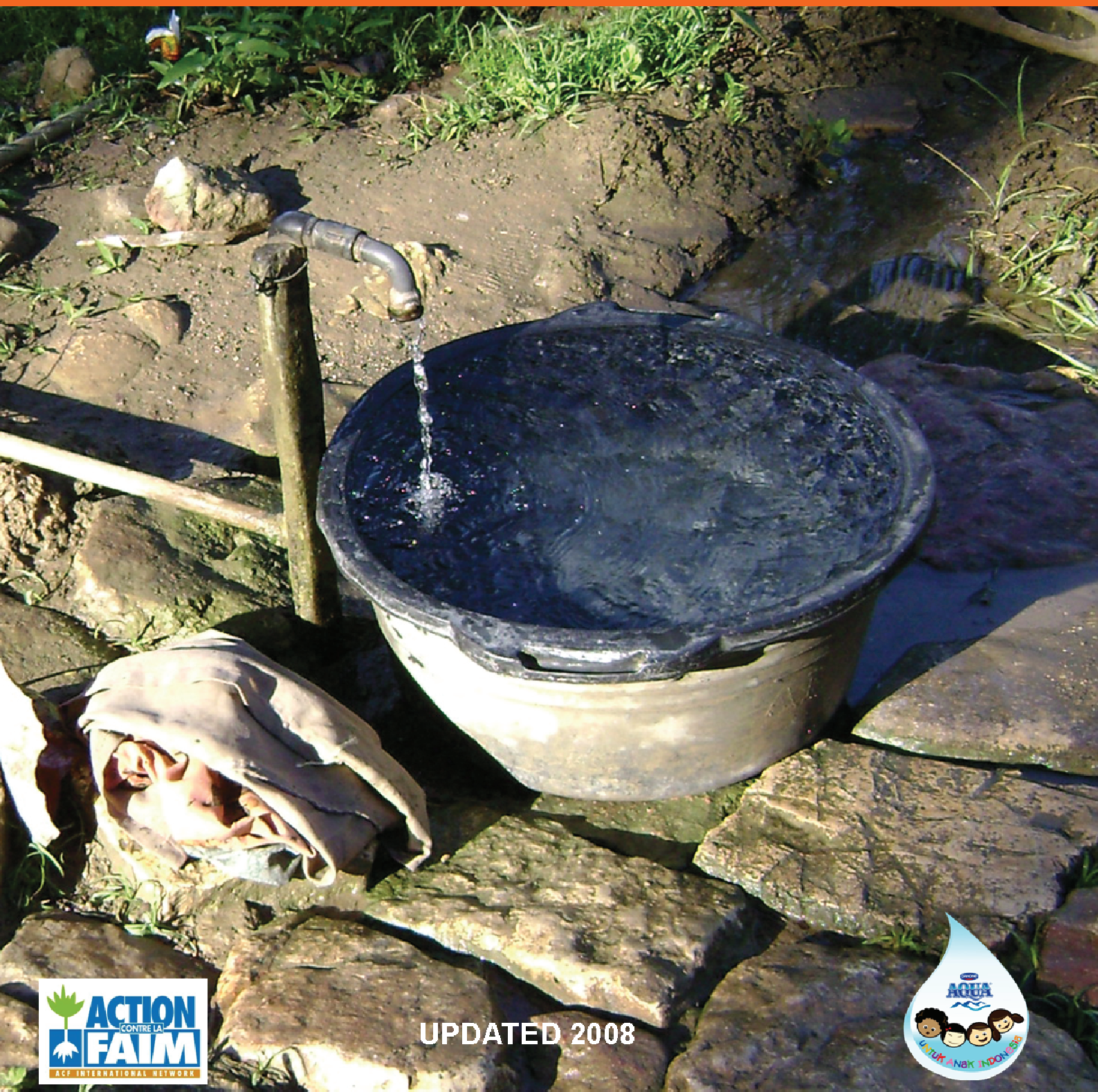

CONTENTS

CONTENTS	1
I. WATER	2
I.1. INTRODUCTION	2
I.1.1. Why getting interested in water?	2
I.2. WATER REQUIREMENTS	3
I.2.1. What is the quantity of water needed per capita per day?	3
I.2.2. What are the domestic water needs?	3
I.2.3. How much water must be available?	4
I.3. WATER RESOURCES	4
I.3.1. Where does water come from?	4
I.4. WATER QUALITY AND COMPOSITION	6
I.4.1. What is the composition of water?.....	6
I.4.2. How water gets polluted and becomes inappropriate for human consumption?.....	7
I.4.3. What are the main pollutants and their effects?	7
I.4.4. What is the fecal pollution?.....	8
I.4.5. How to fight faecal contamination?	9
I.4.6. Which quality drinking water must have?	10
I.5. WATER TREATMENT AND ANALYSIS	13
I.5.1. How to estimate or measure the water quality?	13
I.5.2. What to do if water is polluted?	17
I.5.3. When should water be treated?	20
I.5.4. Which procedures to use for water treatment?	20
II. WATER SUPPLY	32
II.1. WHAT ARE THE DIFFERENT WATER SUPPLY TECHNOLOGIES?	32
II.1.1. Rainwater.....	32
II.1.2. Surface Water.....	33
II.1.3. Groundwater.....	35
II.1.4. Advantages and disadvantages of various technologies of water supply.....	38
II.2. HOW TO CHOOSE THE MOST SUITABLE WATER RESOURCE?	39
II.3. WHAT CAN BE THE EFFECT OF DEFORESTATION ON GROUNDWATER RESOURCES?	42

I. WATER

I.1. INTRODUCTION

I.1.1. Why getting interested in water?

→ **Water is vital**

All life depends on water, which is the main component of living cells: from less than 40% (certain species of plants) to more than 95% (jellyfishes). The human body contains about 80% of water, i.e. 4/5 of its weight. A human body of 60 kg is therefore made up of 48 kg of water and 12 kg only of other substances. A day without water is sufficient for the brain to become unable to work properly (obsessed by the lack of water) and one can die in 2 or 3 days without water.

→ **Water is essential in any human activity.**

People use water to carry out a large number of activities such as:

- Agriculture (irrigation) and cattle breeding (animals).
- Industry (cooling, dissolution, washing, dilution).
- Electricity production (dams and hydropower plants).
- Cooking (to prepare meals).
- Cleaning (clothes, dishes, cars, floors in the home ...).
- To move and to transport equipment (people can use rivers as communication mean).
- Distraction and relaxing (swimming and bathing places).

→ **Human living standard depends on water availability.**

The level of comfort and the development of a population can be measured by the quantity of water this population consumes, per person and per day. Therefore, considering a country where people consume 500 liters of water per person per day, the country where people consume 1000L/p/d can be considered as wealthier. Drought is a main factor of poverty and famine.

→ **Dirty water is lethal**

Dirty water is the cause of more than half of the known diseases, which can be divided in 4 groups, according to their ways of transmission:

- Water-borne diseases represent the category of illness caused by drinking water contaminated by human or animal faeces, which contain pathogenic micro organisms. Water-borne diseases include cholera, hepatitis A, diarrhoea, typhoid...;
- Water-washed diseases are illness developed in conditions where freshwater is scarce and sanitation is poor. Infections are transmitted when too little freshwater is available for washing hands or body. Water-washed diseases include trachoma, leprosy, tuberculosis, whooping cough, tetanus, and diphtheria;
- Water-based diseases are caused by aquatic organisms that spend part of their life cycle in the water and another part as parasites of animals. Water-based diseases

include guinea worm (dracunculiasis), paragonimiasis, clonorchiasis, and schistosomiasis (bilharzia);

- Water-related vector diseases are infections that are transmitted by vectors—insects or other animals capable of transmitting an infection, such as mosquitoes and tsetse flies—that breed and live in or near both polluted and unpolluted water. Water-related vector diseases include malaria, dengue, yellow fever....

I.2. WATER REQUIREMENTS

I.2.1. What is the quantity of water needed per capita per day?

The notion of water quantity needed per capita and per day is subjective because it depends on many factors:

- Climate (air temperature).
- Intensity of physical activity.
- Uses made of water (drinking, cooking, bathing, washing, irrigation...).
- Cultural habits (lifestyle, cooking practices).
- etc.

The average quantity of water used per capita and per day hence varies from a region to another one throughout the world. While an European consumes in average 50 liters per day, an American consumes four times more and inhabitants of developing countries four times less.

Guidelines values for water supply were elaborated by international organizations and acknowledged as norms in terms of public health to answer to humanitarian and priority needs. These guidelines are only indicative and must be adapted according to the context (density of population, climate, and national sanitation norms). Standards are also defined by the national ministry in charge of the water and sanitation sector.

Two types of norms are usually indicated:

- The minimal values, under which risks of outbreak spreading are real and the right of populations to live with dignity is not respected.
- The sanitation norms which correspond to priorities used in a stable political situation.

The guidelines values concerning the necessary quantities of water are given in table 1.

I.2.2. What are the domestic water needs?

It is the quantity of water considered necessary to cover needs at the level of house (family).

The domestic needs cover mainly the following activities:

- drinking,
- food preparation,
- washing, cleaning,

- personal hygiene,
- toilets

I.2.3. How much water must be available?

To cover sufficiently the water needs of a population, it is not enough to provide water in sufficient quantity, it is also necessary to ensure a good access to this water:

- The water points should not be too far.
- The users must be able to transport and store easily the water in their home (if necessary, the distribution of transport and storage containers should be anticipated).
- The waiting time at the water point must be acceptable.

The guidelines values concerning water availability are given in table 1.

Table 1: Guidelines values and values used by ACF for the water supply

	Vital minimum	Sanitation standards
WATER QUANTITY STANDARDS		
Domestic needs	7-20 l/pers/d	30-60 l/pers/d
Health centre	10 l/pers/d	
Hospital	50 l/bed/day	50-220 l/bed/d
School	10 l/student/d	15-30 l/student/d
Market	Used by ACF: 10l/pers/day	
Temple/mosque/church	Used by ACF: 5l/visitor/day	
Small size cattle (goats, pigs)	5 l/animal/d	10-20 l/animal/d
Large size cattle (cows)	30-60 l/animal/d	
ACCESSIBILITY/AVAILABILITY		
Maximum distance between users and water point	125 to 250 m	
Maximum number of users per water point	600	150

I.3. WATER RESOURCES

I.3.1. Where does water come from?

The Earth works as a huge distillation machine, where water evaporates continuously then condenses and falls again on the surface of the globe. This dynamic process is called the water cycle as represented in figure 1.

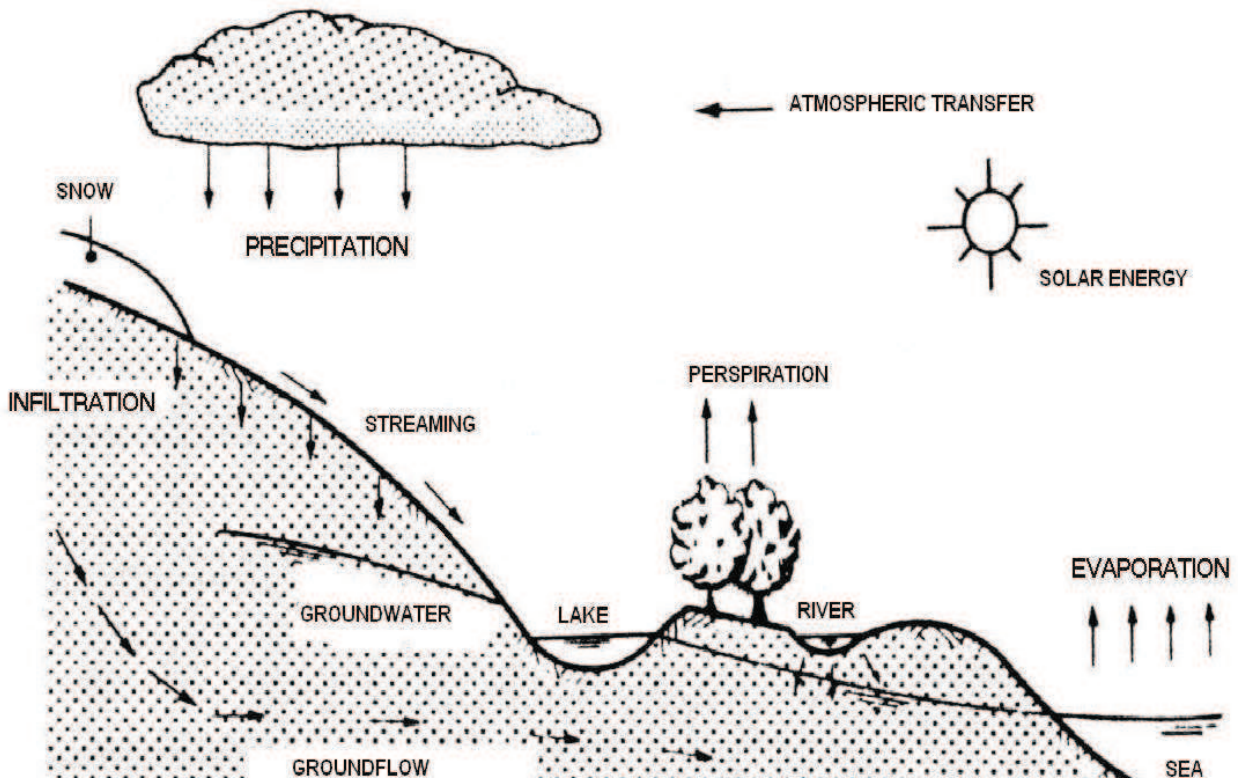

Fig.1: Water cycle

All water which arriving on the surface of the earth falls therefore from the clouds in the form of rain (or of snow in cold countries). Once arrived on earth, water follows the three following ways:

- One part flows rapidly at the surface of the ground.
- One part evaporates (transformed into steam).
- One part infiltrates into the ground.

Water which flows on surface:

By gravity, (gravity being the attraction force exerted by the Earth to all objects) water is attracted towards the lowest points of the ground surface. Following the slopes and natural relief of the ground, water tries to find its way, flowing first in the form of small streams, which merge to form bigger streams. These merge again to form rivers, which flow finally in to the sea.

Water which evaporates:

On the continents, part of rainwater evaporates at the first contact with the ground heated by the sun. This phenomenon is the cause of the white haze formed above the road after a short rain: this haze is just steam. A part of the surface water and shallow groundwater can also evaporate under the influence of the sun.

However, the most important continental contribution of steam water is represented by the part of rainwater which evaporates in the air through plants: right after having penetrated in the plant's roots, shallow ground water is absorbed, goes up in plants stem and tree trunks until the leaves where it evaporates.

A large part of water also evaporates above the oceans, under the influence of solar energy. The water that evaporates reaches the atmosphere to form clouds and is subject to the various winds and movements of transfer.

Water, which infiltrates in the ground:

A part of rainwater infiltrates in the ground through a multitude of small interstices (small empty spaces). This way, presenting numerous obstacles to be by-passed, is of course very long and difficult. This water, which had become underground water, keeps on being part of the water cycle: it forms groundwater, which flows slowly below the ground and supply springs, rivers and eventually discharge into seas.

The Earth has four large reservoirs of water: the sea (the oceans), the atmosphere (the sky), groundwater, and surface water (rivers/lakes). Volumes and duration of stay of the water in each of these reservoirs are represented in table 2. However, the local relief, climate or geology makes the water cycles varying in an important way from a region to another.

Table 2: Large natural reservoirs of the planet.

Reservoir	Capacity (%)	Average duration of stay of water
Seas (oceans)	80	3,172 years
Atmosphere	0.3	4 months
Rivers and lakes	0.1	5.6 years
Groundwater	19.6	8,250 years

I.4. WATER QUALITY AND COMPOSITION

I.4.1. What is the composition of water?

Pure water is composed of molecules formed by two atoms of hydrogen and one atom of oxygen (H₂O). However, due to its capacity to dissolve numerous chemical compounds in high quantity, pure water can be very rarely found in nature.

During its trip through the atmosphere (during condensation and precipitation phase), water absorbs variable quantities of carbon dioxide and other gases contained in the atmosphere, as well as traces of organic and mineral substances.

During its trip through the earth's crust, water reacts with ground minerals and rocks. The main components dissolved in surface water and groundwater are sulphates, chlorides, sodium and potassium bicarbonates, calcium and magnesium oxides. It is important to underline that the largest part of these natural elements usually contained by water are essential to human life (fluorine, magnesium, calcium...).

Sea water contains important quantities of sodium chloride (or salt) and other numerous soluble compounds. As pure water constantly evaporates, the proportion of impurities, which gives its saline character to the seawater, increases.

Generally, we can say that the elements met in water are the following:

- Suspended substances:*
- Sands
 - Clay
 - Colloidal substances (solid particles in suspension in a liquid)
- Dissolved substances:*
- Mineral salt (sodium...)
 - Organic compounds,
- Dissolved gas:*
- O₂, CO₂, N₂
 - CH₄, H₂S
- Living organisms:*
- bacteria,
 - (non-visible by naked eye) - virus

I.4.2. How water gets polluted and becomes inappropriate for human consumption?

It is during its trip through the atmosphere, and mainly when it flows at the surface of the ground, that water becomes polluted by being into contact and carrying substances such as dust, wastes produced by human activity, excreta, rotten plants, etc.

It is important to underline that human activities have a growing effect on the water cycle by introducing external substance in the nature (chemicals for example) or by increasing abnormally the concentration of certain substance in the nature (organic substances for example).

I.4.3. What are the main pollutants and their effects?

The main pollutants, their origin and their effects are presented in table 3.

Table 3: Water Pollutants

Type of pollution	Pollutants	Origin	Effects	Direct impact on human body
Natural organic components	Easily biodegradable organic matter <i>= polluting substance if presents in high concentration</i>	- Domestic wastewaters - Industries (food and paper industry...)	Increase of the number of bacteria, which degrade organic substance, presents in the water → reduction of oxygen in water → death of fish and other organism by asphyxiation.	No
Toxic	- Heavy metals (like Cadmium, mercury, lead, chrome), - Pesticides and biocides, - Solvents,	- Insecticides, and herbicides (weed killer), - Industries; especially chemical industries and metals industry (chrome-plating...).	- Various disorders, carcinogen, - Multiple negative effects possibly leading to death	Yes
Biological	- Bacteria,, - Virus.	Excreta	Transmission of diseases like Rota virus or Cholera	Yes

Nutritive substances	Nutrients (Nitrogen, Potassium and Sodium) = <i>necessary substances in small quantity but polluting if presents in high concentration</i>	- Agriculture (fertilizers), - Domestic waste water, - Intensive cattle breeding (animal excreta).	- Eutrophication: more minerals in water= vegetable overproduction =less oxygen (asphyxia of fish)	No
			- NO ₂ (Nitrogen dioxide) provoking blood disease to the babies or foetus.	Yes
Physical pollution	Suspended substances	Soil washing	Non-aesthetic, light disturbance	No
	Radioactive elements	Nuclear plant	- Mutation. - Disease of aquatic organisms	Yes
	Temperature	- Industry cooling water, - Power plants.	Asphyxiates all fish species	No

In the rural areas where ACF is working, the industrialization is often very limited, and the main source of water pollution is the contact with excrements. It is by the excrements that are transmitted a large number of diseases: it is what we called faecal contamination.

However, there are existing sources of toxic contamination that should be monitored:

- Industries, garages and mines discharge pollutants in surface water (mainly in rivers).
- Pesticides are increasingly used in agriculture. The toxic that contains pesticides, end up in water after the first rains.
- Analysis of water quality revealed a presence of arsenic (As) in certain groundwater (well and boreholes) in south-east Asia. Arsenic is a toxic metal which can be naturally present in the underground rocks.

Some people, who drink regularly water containing arsenic over a long period of time (15 to 20 years), can develop health problems (respiratory problems, damage on the internal organs, skin infections) that might become cancer. It seems that the presence of arsenic in groundwater is often linked to high concentration of iron and manganese.

I.4.4. What is the fecal pollution?

Excreta (of human or animal) contain a high amount of microorganisms. Micro-organisms are living beings of very small size, not visible to the naked eye (viruses, bacteria, protozoan, amoebas...). These microorganisms, which make integral part of our environment, can be harmless (of no consequence for human health) or pathogenic (dangerous for health). All the faeces contain micro-organism, but only contaminated people present pathogenic micro-organisms in their faeces. When a contaminated person defecates in the environment, the pathogenic microorganisms contained in the excreta can contaminate healthy persons. The different ways of contamination are illustrated in figure 2.

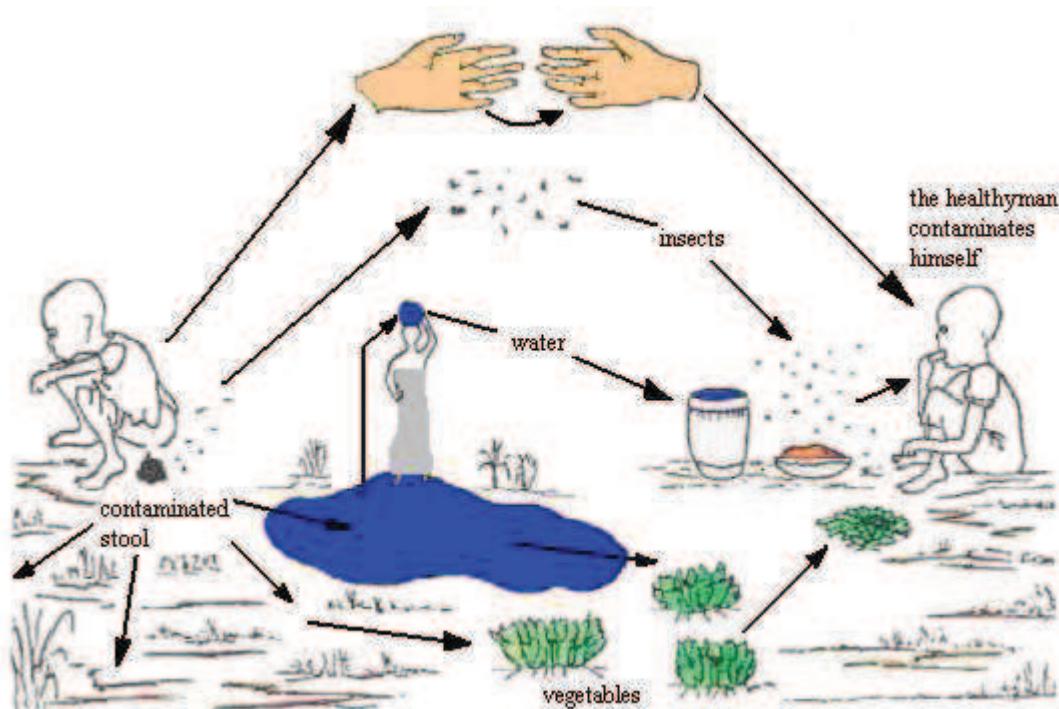

Fig.2: The various routes of fecal contamination

Main diseases transmitted by pathogenic micro organisms are given in table 4.

Table 4: Diseases transmitted by the excrements

Microorganisms	Disease	Clinical symptoms
Virus	Hepatitis A, E	Jaundice (liver)
	Poliomyelitis	Paralysis followed by after-effects
Bacteria	Typhoid	Nervous and digestive disorders, fever
	Cholera	Dysentery
	Shigella	Diarrhea, vomiting
Amoebas	Amoebiasis	Diarrhea, vomiting
Worms	Worm infection	Gastro-intestinal disturbances

I.4.5. How to fight faecal contamination?

Various ways to fight faecal contamination are illustrated in figure 3, and listed as follows:

- To avoid any potential dissemination of pathogens using sanitation → latrines construction + proper use of latrine = *barrier 1 and 2*.
- To pathogen free water → construction of appropriate infrastructures for water supply + water resources protection + good handling storage and storage of water in the house = *barrier 3 and 8*.

- Have a good body hygiene → to wash hands regularly = *barrier 5*.
- Eat healthy food (i.e., washed with clean water, well cooked and protected from the flies) = *barrier 4, 6 and 7 and 9*

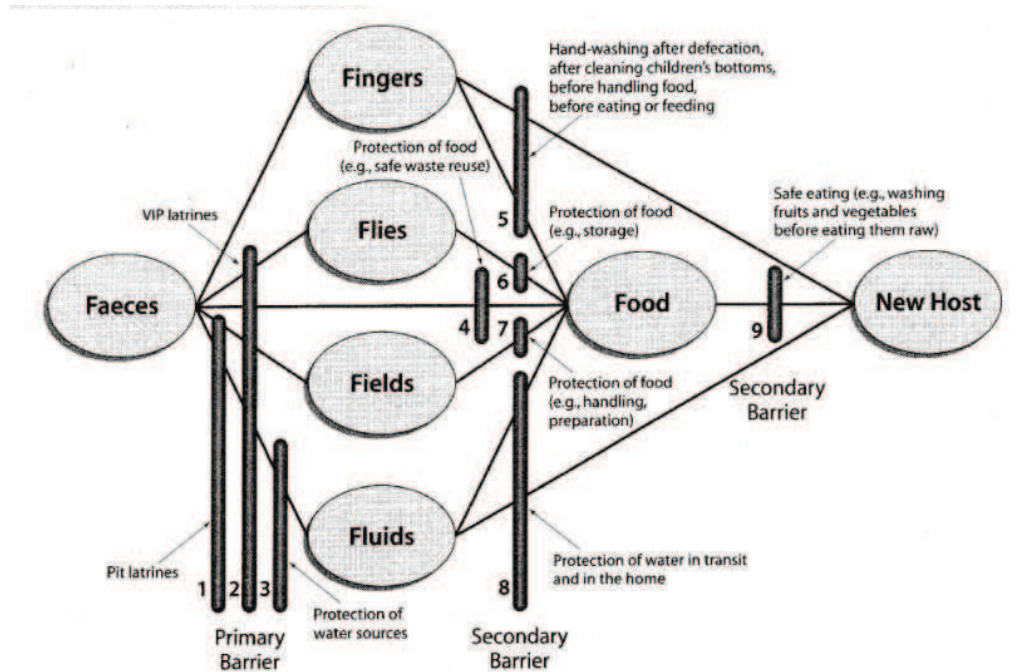

Fig.3: The '6 F' diagram of faecal contamination and its barriers

We can conclude that the construction of proper water supply infrastructures is not a sufficient condition to avoid the proliferation of diseases of faecal origin.

Hygiene promotion and sanitary education are essential and complementary to the implementation of infrastructures. The objective is to sensitize the users to the importance of drinking water for health, and to modify the behaviours related to hygiene and water.

Three major topics must be tackled:

- The quality of water from the water collection point until consumption.
- Body hygiene.
- Environmental sanitation.

I.4.6. Which quality drinking water must have?

Generally, water can be used for drinking purposes if:

- It has no taste, smell nor significant colour (or within the limits accepted by population).

- It has not been contaminated by excreta and do not contain (or very little) pathogenic organisms.
- No sources of contamination linked to a human activity was located in the surrounding of the water source (such as, factory, garage, pesticide used in agricultural fields...).

The World Health Organization (WHO) has established detailed norms for drinking water quality. These norms, internationally acknowledged, give the guidelines values for substances that can have a negative impact on health if they are present in water, as well as for the substances and parameters that may make the users refusing to drink the water (color, taste, smell...).

It is necessary to use also common sense when using these norms: the values indicated must be put into perspective of the local context related to the ground structure (geology), or the level of local water supply service (average quality of water supplied, local norms, drinking water coverage).

A sufficient quantity of reasonably healthy water remains preferable to an insufficient quantity of water presenting a very good quality: not having enough water to ensure a minimum hygiene level can lead to more acute health problem than to supply a medium quality of drinking water.

Table 5, 6 and 7 were made based on the data provided by WHO (*"Guidelines for Drinking Water Quality"*). These guideline values correspond to the main parameters used for monitoring the drinking water quality. Other parameters, corresponding to very rare chemical components, difficult to measure, and which do not cause frequent problems, are not mentioned. It is however necessary to remain attentive for urban or industrialized zones, usually presenting more atypical sources of pollution.

Table 5: Microbiological quality of drinking water

Parameters	WHO – Guideline values	Analysis
Thermotolerant coliforms (TTC)	0/100 ml	Faecal pollution indicator
Faecal Streptocoques	no standard	Faecal pollution indicator
Total Coliforms	0/100 ml in 95% of treated water samples	Indicator of the efficiency of treatment (disinfection). They are not compulsorily the sign of faecal pollution.

Table 6: Chemical substances for which the presence in the drinking water present a sanitary importance (O = origin and S = effects on health).

Parameters	WHO-Guideline values	Analysis
Arsenic (As)	0.01 mg/l	O: rocks, industrial waste (iron and steel industry) S: proven carcinogenic effect (coetaneous cancers -EU)
Fluorides (F)	1.5 mg/l	O: rocks, manure, food (fish), industrial pollution (aluminium manufacture) S: dental and bone fluorosis
Manganese (Mn)	0.5 mg/l (provisional value)	O: rocks (often associated with iron) S: toxic effect on the nervous system if C > 20 mg/l. Problem of turbidity and taste if C > 0,3 mg/l
Nitrites (NO ₂ ⁻)	3 mg/l (provisional value)	O: organic substances S: child methaemoglobinaemia
Nitrates (NO ₃ ⁻)	50 mg/l	O: organic substances, soil leaching (erosion), fertilizer, residual water S: child methaemoglobinaemia
Chlorine (Cl ₂)	5 mg/l	O: residual product of water disinfection S: no proven problem

Table 7: Drinking water component and parameters that may lead to acceptance problem from users (O = origin and S = effects on health).

<i>Physical parameters (organoleptic)</i>		
Parameters	WHO-Guideline values	Analysis
Colour	15 UCV	
Taste and odour	Acceptable by users	
Turbidity	5 NTU 1 NTU for disinfection	O: suspended substances, colloids, dissolved substances
Temperature	Acceptable by users	
<i>Inorganic substances</i>		
Parameters	WHO-Guideline values	Analysis
Aluminium (Al ³⁺)	0.2 mg/l	O: coagulants used in the water treatment, industry S: no proven problem. Colour problem if C > standard
Ammonia (NH ₄ ⁺)	1.5 mg/l	O: nitrogenized organic substances: excreta, waste water, plants (vegetables) S: no proven problem. Problem of taste and odour if C > 1,5 mg/l
Sulphur hydrogen (H ₂ S)	0.05 mg/l	O: rock, anaerobic organic substances S: no proven problem for ingestion, lethal by inhalation
Chloride (Cl ⁻)	250 mg/l	
Sodium (Na ⁺)	no standard	S: no proven problem. Taste if CCL- > 200-250 mg/l
Hardness (Ca ²⁺ + Mg ²⁺)	no standard	O: hardness=calcium and magnesium concentration S: no proven problem. Taste, scaling if C > 200 mg/l
Phosphate (PO ₄ ⁻)	no standard	O: organic substance, detergent, manure S: no proven problem
Potassium (K ⁺)	no standard	O: manure S: no proven problem
Sulphates (SO ₄ ²⁻)	250 mg/l	O: rocks, industries S: purgative effect, gastro-intestinal irritation. Problem of taste, water aggressive to concrete if C > 250 mg/l.
Iron (Fe)	0.3 mg/l	O: rock, coagulants (aluminium sulphates) S: no proven problem. Problem of taste and colour

Oxydizabilty	No standard	This parameter is used to measure the presence of organic matters (since they are easily oxydizable).
Dissolved oxygen (O ₂)	No standard	O: atmosphere oxygen, photosynthesis S: no proven problem
pH	No standard	O: hydrogen ion S: no proven problem
Conductivity	No standard	O: substances in solution in water S: no direct problem

I.5. WATER TREATMENT AND ANALYSIS

I.5.1. How to estimate or measure the water quality?

The main tools in the field to estimate the water quality are the sanitary analysis, completed by the bacteriological analysis and the physico-chemical analyses.

→ Sanitary analysis:

Compared to the other indicators, the sanitary analysis offers a more general (thus more significant) approach. It allows revealing the vulnerability of the water source to pollution and results of the analysis are valid during a long period of time. In most of cases, a field sanitary analysis, even used alone without other analysis, can give a rather good idea of vulnerability of a water source to pollution.

All configurations allowing excreta to be in contact with water (in a direct way, such as direct defecation in water, or indirect way, such surface water run-off) represent a potential pollution source.

Industries, mines, car repair shops, handicraft workshops, cultivated fields where pesticides are used... also represent a potential source of pollution.

The sanitary analysis looks for these risky situations. It must be carried out on all the ways taken by water, from the water point to the consumers.

As an example, the two following cases can occur:

1. *Water resource currently used (hand dug well for example).*

If the sanitary analysis reveals the presence of many cases waterborne diseases contagion, "diarrheas" for example, you can suspect a faecal pollution of water. In that case, we have to find at which level water is in relation (direct or indirect) with excreta.

2. *New resources will be used (river, spring...).*

We must look if water is exposed to contamination, and estimate its vulnerability to pollution.

→ Bacteriological Analysis:

The faecal contamination of water can be evaluated through bacteriological analysis. Being a complementary tool of sanitary survey, it only gives the picture of the water quality at the

time of sample; thus, it does not have any value in time, and needs to be interpreted by a sanitary survey.

The pathogenic organisms which can be present in water are extremely numerous and various (bacteria, virus...). Their presence is always linked to pollution by faeces. It can be difficult to draw attention to these organisms when they are in water, first because they are too numerous to be the object of a specific research, and secondly because their lifetime outside the body of the host is sometimes short. It is then better to look for the presence of germs which are always present in big number in the faeces of human and the warm-blooded animals, which can live more easily outside the body of human/animals and which can be easily identified in a laboratory. These germs are called "faecal pollution indicator" germs, and their presence is a proof of the existence of a faecal contamination at the moment when the water sample was taken. Their presence in water is not the proof of pathogenic germ presence, but of a strong risk of pathogenic presence.

The most useful indicator to estimate faecal pollution is the Thermotolerant bacteria, 90% of them being *Escherichia Coli* bacteria, commonly called *E. coli*. *E. coli* are always abundant in the human faeces and is enough resistant to be located in water, outside the body.

The easiest method to look for and identify *E. coli* is the membrane filtration. It consists in filtering a certain volume of water on a porous membrane (with holes of $0.45\ \mu\text{m}$), adapted to let water pass but retain bacteria. This membrane is then put in a hot environment that allow the growth of Thermotolerant coliformes, but not of the other bacteria: incubation 16-18h in 44°C (the name of thermo-tolerant bacteria comes from this, because others coliformes do not develop themselves above 37°C), on a favourable nutritious environment. After 16h, the colonies of bacteria are visible with the naked eye and are counted. Following the principle that each bacteria present in water give a visible colony of bacteria, results are expressed in number of bacteria by 100 ml of filtered water. The main steps of bacteriological analysis are illustrated on picture 4.

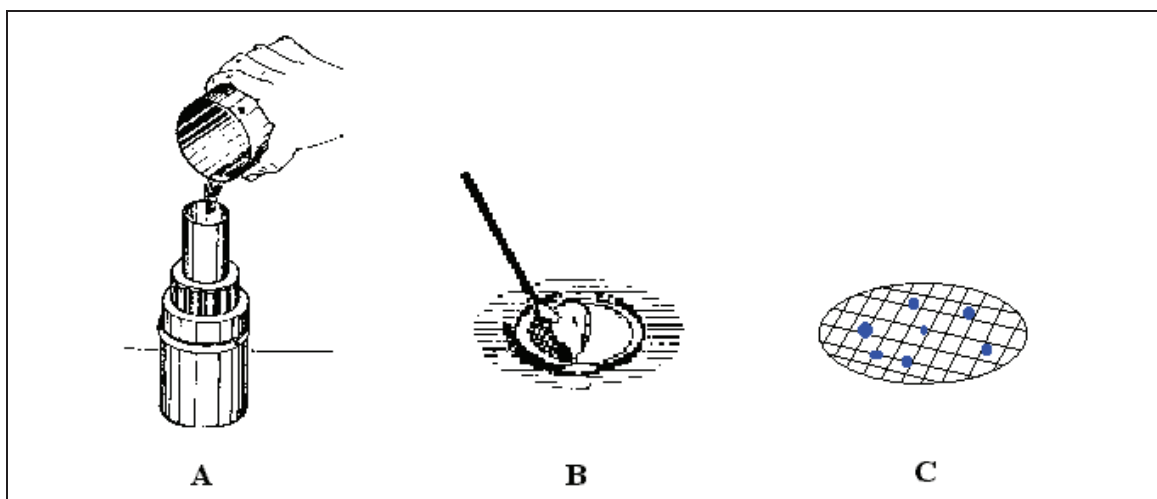

Figure 4: Main steps of a bacteriological analysis (A: Filter on a membrane 100 ml of water to be tested, B: Put the membrane on a nutritious environment and incubate in 44°C , C: after 16h to 18h of incubation, count the number of formed colonies - in our example there are 7 bacteria for 100 ml of water).

→ **Physical and chemical Analysis:**

• Conductivity

Conductivity is the capacity of water to conduct the current between two electrodes. Given that the majority of salts (mineral substances) dissolved in water are electrically charged, the measurement of conductivity also measure the quantity of salts dissolved in water.

Conductivity also varies according to water temperature: it increases when the temperature increases. The measurement of the results must then be presented in term of "equivalent conductivity" at 20 or 25°C. Measurement devices used in the field (conductimeter equipped with a probe) makes in general this conversion automatically.

This parameter must be imperatively measured in the field. The procedure is easy and allows obtaining very useful information to characterize water (see table 8). Contrasts of conductivity allow highlighting pollution, zones of mixing of two type of water, or infiltration (of sea water for example).

The most frequent measurement unit is the micro-Siemens by cm ($\mu\text{S}/\text{cm}$), but conductivity is sometimes measured in Total Dissolved Solids (TDS) in mg/l, or in resistivity in ohms per cm (Ωcm).

$$\text{TDS (mg/l)} = \text{conductivity } (\mu\text{S/cm}) \times 0.64$$

$$\text{Resistivity } (\Omega\text{cm}) = 1,000,000 / \text{conductivity } (\mu\text{S/cm})$$

Table 8: Interpretation of the conductivity values (at 25°C)

Values ($\mu\text{S}/\text{cm}$)	Information
$\mu\text{S}/\text{cm} < 50$	- very low conductivity, water deprived of minerals, rather unfit for consumption, - unpolluted rainwater
$100 < \mu\text{S}/\text{cm} < 500$	- average conductivity, water containing a lot of minerals but suitable for consumption, - No problem of salinity.
$500 < \mu\text{S}/\text{cm} < 1000$	- strong conductivity, water rich in minerals but no problem for human consumption, - possible brackish taste.
$\mu\text{S}/\text{cm} > 1000$	- very strong conductivity, water very rich in minerals, not really suitable for human consumption, - strong possibility of salinity taste problem.
$\mu\text{S}/\text{cm} = 2000$	- maximum limit for human consumption and agriculture.
$\mu\text{S}/\text{cm} = 3000$	- maximum limit for water supply to cattle

• Turbidity

Turbidity allows specifying visual information regarding the water transparency. It measures the presence of suspended particles in water (organic waste, clay, microscopic organisms...). Inconveniences caused by turbidity for the users are relative: certain populations, used to consume very turbid water, do not appreciate the qualities of very clear water. However, a

strong turbidity can allow micro-organisms to get fixed on the suspended particles: the bacteriological quality of turbid water is therefore rather suspect. Turbidity is measured in the field using a transparent plastic tube:

- Fill the tube with the water to be analysed.
- Remove slowly the water from the tube while observing the coloured circle drawn on the bottom of the tube
- When this circle becomes visible, read the value of the corresponding turbidity marked on the tube.

The most frequent turbidity measurement unit is "Nephelometric Turbidity Unit (NTU)", but turbidity is sometimes expressed in "Jackson Turbidity Unit (JTU)". These two units have the same value, that is to say 1 NTU = 1 JTU.

The interpretation of the values of water turbidity is given in the table 9.

Table 9: Interpretation of water turbidity values

Values	Information
NTU < 5	- Pure water without colour visible to the naked eye. - Ideal for consumption. - Can be directly chlorinated and filtered.
5 < NTU < 30	- Slightly coloured water. - Can be directly filtered. - Must be filtered or decanted before chlorination.
NTU > 50	- Coloured water. - A few days are needed for filtering (on a slow sand filter for example). - Pre-treatment is necessary before chlorination.
NTU > 200	- Must be pre-treated before slow sand filtration. - Must be filtered or decanted before chlorination.

• pH

The pH (potential Hydrogen) measures the concentration of ions H⁺ in water. It measures the balance between acid and base in the water on a scale of 0 to 14, 7 being the neutral pH.

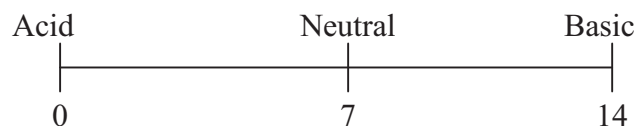

The pH can be measured in the field using a pH-meter or by colorimetry (using of strips, or Phenol Red pills for example). The interpretation of the pH values of water is given in table 10.

Table 10: The interpretation of the pH values of water

Values	Interpretation
pH < 5	- strong acidity, supposed chemical pollution, - unsuitable for human consumption, - rarely met in natural water (except sometimes, spring water and streams in granite area).
5 < pH < 6,5	- average acidity, - unsuitable for human consumption according to the WHO standard.
6,5 < pH < 7	- low acidity, water can be corrosive but is suitable for human consumption.
7 < pH < 8	- almost neutral but with low alkalinity, - frequent in the limestones areas, - water suitable for human consumption.
8 < pH < 9	- average alkalinity, suitable for consumption.
pH > 9	- strong alkalinity, unsuitable for consumption, - met sometimes in stagnant water colonized by plants.

- Dissolved elements

The dissolved elements can have an impact on colour, taste and smell of water.

The main dissolved elements that can be present in the water are as follows: calcium, magnesium, sodium, potassium, sulphate, chlorides, nitrogen, nitrates, iron, fluorine and aluminium.

It is generally not necessary to measure regularly and thoroughly the concentration of these elements in water. However it can be sometimes necessary to take certain measurements when it is known that an area present a potential risk that can affect the health of the consumers.

Iron is a dissolved element frequently met in groundwater. Its presence in groundwater is linked to the local geology. Present in its reduced form in groundwater, iron is oxidized by the oxygen in the open air and precipitates in ferric form when ground water is pumped outside of the ground. The apron around the wells are then coloured in brown/rust and populations refuse to use this water. Indeed, if a water containing a lot of iron is used for the laundry, it can colour the linen and can have a marked metallic taste when it is consumed.

I.5.2. What to do if water is polluted?

When the field survey gives you a hint that water is polluted at the level of the users (diarrheas frequent among the consumers, identified source of pollutant, poor protection of wells, presence of excreta in the area around water points, etc), the following actions are necessary:

- 1) Make a list of water resources and choose those which present the lowest sanitary risks
- 2) Protect the water sources against pollution.
- 3) Prevent water to get polluted during its transportation or storage in the house.

- Make a list of water resources and choose those which present the lowest sanitary risks

Springs, deep hand dug wells (> 10m) and deep boreholes will be preferred to shallow hand dug wells and boreholes (< 10m) and other shallow water sources: Indeed, the deeper the groundwater comes from, the better will be its bacteriological quality.

Surface water sources (river, lake and groundwater located at less than 3 meters deep) should not be used given the strong probability of faecal pollution and the fact that they can present too much suspended matters.

- To protect the water sources against pollution

It is preferable to take measures aiming at preventing water from being polluted, rather than to treat water outside of the water point. The objective of the water point protection is to prevent the faecal contamination (direct or indirect) of water.

- Hand dug wells and boreholes

- Build a fence around the water point to prevent the animals from getting close.
- Move away all sources of pollution (pit latrines, toilets, rubbish collection point, septic tanks...) to a minimum of 30 meters from the water point, in a downstream part if there is a slope.
- For wells, install a water collection system which prevents its direct contamination when people collect water. The well should be closed by a reinforced concrete slab, and the installation of a electric or manual pump is a preferred solution.
- Build an apron and a water drainage system.
- For the wells, install a concrete sanitary seal (on the first 3 meters).

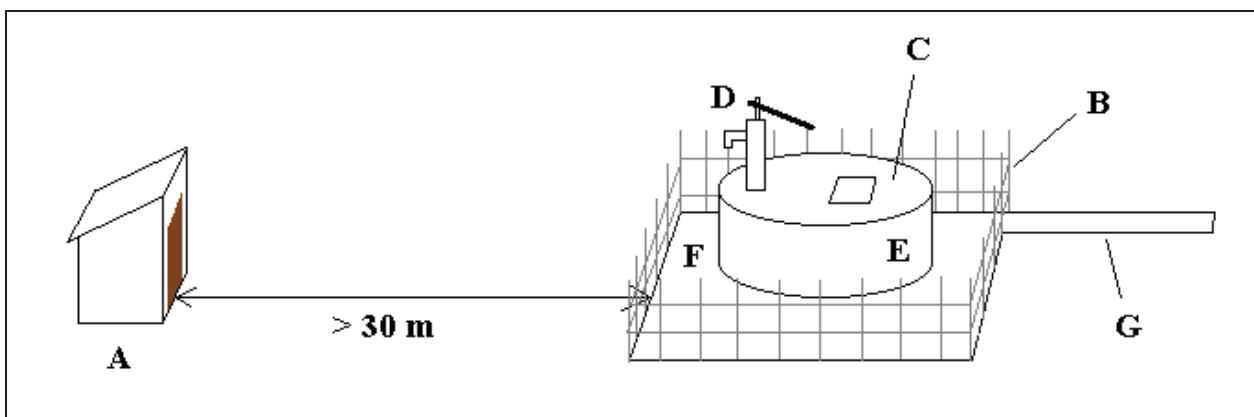

Fig.5: Usual protection infrastructure of a well (A: latrines/toilets at 30m of distance, B: protection fence, C: cover with manhole, D: pumping system (hand pump), E: well head, F: apron).

- Spring

- Install a protection fence around the spring.
- Make sure that there is no source of pollution (latrines, septic tank animals grazing or breeding place) in a perimeter of 30 meters, especially in the upstream part of the spring.
- Make a drainage system around the spring (and especially above) to prevent the spring from being flooded by rain water/ surface waters.
- To protect the tapstands with a fence, an apron and a drainage system
- make sure the trees are not cut above the spring, because it can make the spring disappear.

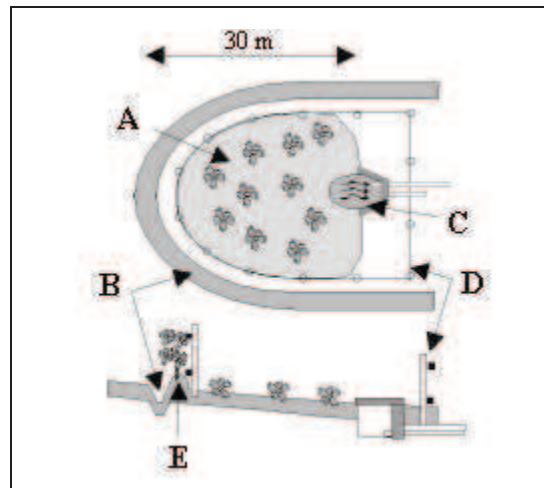

Fig.6: Protection perimeter of a spring (A: protection perimeter, where small trees and grass can be planted, B: open ditch to drain surface water, C: spring catchment, D: fence or hedge, E: protection embankment where possibly various plants can be planted to avoid erosion)

- Surface water

It is very difficult to protect surface water from pollution

For rivers, water must be fetched upstream of all other activities (bathing, washing, animals drinking). Make sure people and animals do not use the river banks to defecate.

→ To prevent water from getting polluted during its transportation or storage in the house.

It is useless to have a clean drinking water source if water is no more potable at the time of consumption: it is therefore necessary to prevent water from getting polluted during its transportation and storage.

- The container of transport should not be the same as the one used for storage, because it is usually less protected (for example, buckets are usually used), and more sensitive to pollution, because it goes outside the house). It must be closed and cleaned regularly.

- The storage containers must be located in a high position (not in the ground for example) and in the shade, out of reach for children and animals.
- Water should not be fetched from the storage containers directly with a cup (which remains generally exposed to insects and dirty hands) but must be poured or taken out from a tap installed on the container.

I.5.3. When should water be treated?

Well protected groundwater can be considered as not polluted, and used without treatment. Surface water must be considered as potentially polluted. If no other solution can be found than to use surface water, a treatment can be then considered at community or household level.

Warning!

- Treated polluted water always remains potentially harmful, because the smallest mistake in the treatment system can have tragic consequences.
- There is no perfect treatment system, because all systems require equipments, competences, monitoring, and regular maintenance.

I.5.4. Which procedures to use for water treatment?

A water treatment procedure is a specific technique which allows correcting a special parameter of the water. The choice of the procedure (or the combinations of procedures) to use is thus made according to the parameters to be treated.

The treatments of turbidity are:

- storage and decantation,
- flocculation-decantation,
- simple filtration.

The treatments of fecal pollution in water are:

- chlorination,
- slow sand filtration,
- boiling,
- ozonization or ultra-violets (UV) ray.

The treatment of iron and manganese are:

- aeration, decantation or simple filtration.

It should be reminded that a protected source of safe water is always better than treated polluted water!

→ Storage and decantation

When should this technique be used?

Storage and decantation must be used as a pre-treatment for water containing suspended substances that you want to chlorinate or filter.

Principle:

The lifetime of the pathogens in water is usually limited; consequently, the storage of water allows eliminating a part of the pathogens, but in general, storage time are not long enough to eliminate them all. During storage, a decantation occurs also, where the suspended substances as well as large size pathogens (eggs of helminthes, cysts of protozoa) will settle down at the bottom of the container.

Implementation:

Fill a transparent bottle with water to be treated, let it rest in shade without touching it during one hour. If after an hour the bulk of the suspended substances did not settle, it will be necessary to use another technique (flocculation for example).

If it is possible to do it, store water in a reservoir reserved for this purpose: it must be clean, covered, protected from dust and insects. Store a volume of water equivalent to the consumption during the storage period.

Advantages:

- Simple and inexpensive technique.
- Allows eliminating part of the pathogens and decreasing turbidity at the same time.

Disadvantages:

- Request a certain level of water management (volume of storage).
- Must be generally used like a pre-processing (and not like a simple treatment), because times of storage used usually do not allow destroying all the pathogens.

→ Flocculation/decantation

When should this technique be used?

Flocculation and decantation must be used to remove from turbid water the suspended substances it contains (for the purpose of chlorination, for example).

Principle:

Certain suspended substances do not settle down or takes too much time to settle naturally (it can be the case of the substances which give colour to the water). These substances are maintained in suspension by electrostatic repulsion and hydration phenomena. Certain chemicals, called coagulants, have the capacity to neutralize these phenomena and allow the formation of flock (amalgamated suspended substances). The flocks, sufficiently large, will settle down by gravity.

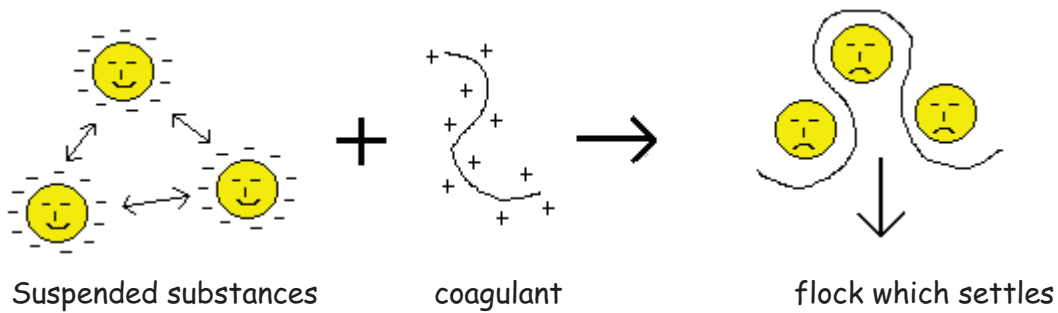

Implementation:

The coagulant often used is the aluminium sulphate ($Al_2(SO_4)_3$) which can be found in solid form (in pieces of the size of the fist). This coagulant is not used in its solid form, but is diluted to form a "mother solution" with which flocculation will be implemented on water to be treated.

The field implementation should be done as follows:

1. Prepare a 5% mother-solution (to put 1 kg of aluminium sulphate in 20 litres of clean water). It is possible to preserve this solution in a jerrycan of 20 litres. Before each use, mix well the solution.
2. Determine the amount of product to be used. This amount depends on the quality of the water to be treated. Determine the amount to use by making test samples with increasing amounts of mother solution: for example 4 ml of mother solution in 10 litres of water to be treated, then 10 ml, 20 ml and 30 ml of mother solution, always in 10 litres of water to be treated. After having shaken then vigorously during a few minutes and let them rest during 1hour, examine the samples: the smallest proportion giving the best results is to be used.
3. Control the pH of water to be treated. The aluminum sulfate makes the pH of water decrease: control that the pH remains between 6.5 and 9. If the pH goes down below 6.5 it is necessary to carry out a new test with a lower proportion of coagulant and a longer time of decantation. The correction of pH must be done by a specialist.
4. Introduce the aluminium sulphate solution into the water reservoir to be treated at the time of its filling to facilitate mixing. Mix vigorously and let the flocks settle down from 6 to 12 hours. Decant the treated water in another reservoir before chlorinating it, the simplest way being to have two reservoirs in series, one for flocculation and the other for chlorination.

Advantages:

- Allows eliminating the substances for which natural decantation is difficult or impossible

Disadvantages:

- Long and tedious process which requires material, competences, a monitoring, and a regular maintenance → better to avoid having to make this type of treatment!

→ Simple filtration (fast)

When this technique should be used?

It must be used as a pre-treatment, when the suspended substances must be eliminated from water to prepare it for chlorination or slow sand filtration. This type of filter is used to treat water presenting a turbidity higher than 20 NTU.

Principle:

Mechanical filtration allows retaining the suspended particles.

Implementation:

Make water pass through a layer of filtrating materials presenting a relatively uniform diameter of 1 to 2 mm (sand for example). To avoid the filter to get rapidly clogged, the water should not pass through the filter too fast: a yield of 10 m³/h per m² of filter surface is a good compromise. To pre-filter the water and avoid a rapid clogging, it is possible to install a layer of gravel (of 10 cm for example) in the upstream part of a sand layer (with a 30 cm thickness for example).

The regular washing of the filter is necessary (at least once a week). To do so, the filter should be "backwashed": clean water should be passed in the filter on the other way. It is also recommended to backwash the filter with a chlorinated solution of 100 mg/l once per month.

Advantages:

-The elimination of the suspended particle out of very turbid water charged (>20 NTU).

Disadvantages:

-A good maintenance/washing of the filter is imperative not to transform the filter into a source of contamination.

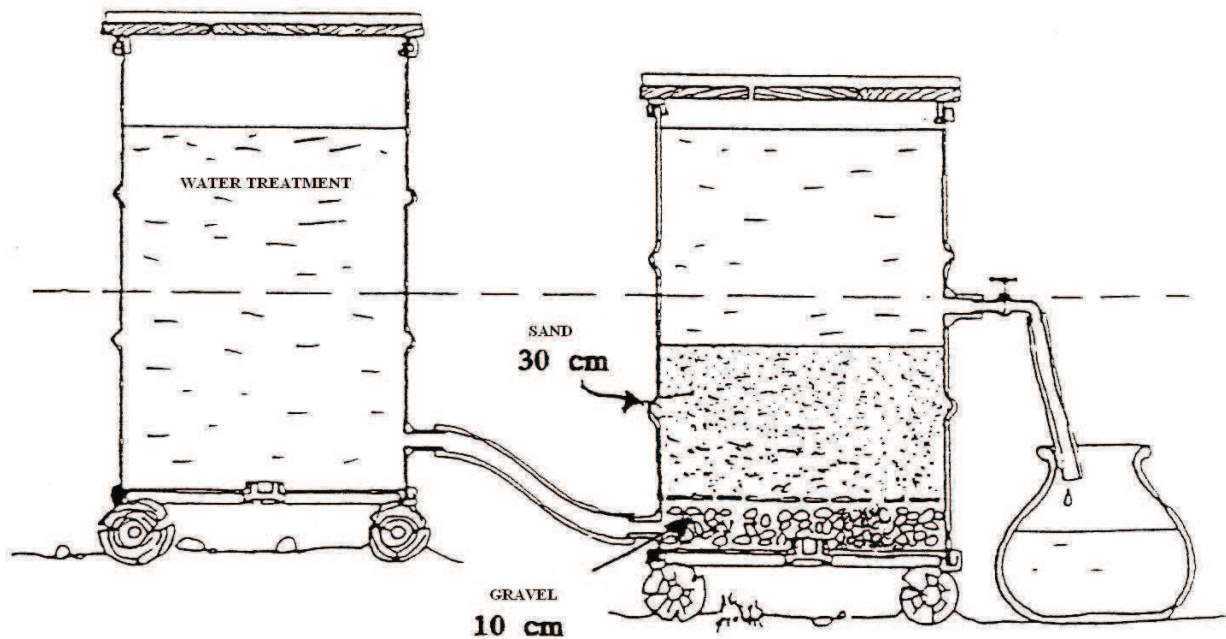

Fig.7: Example of simple construction of fast filter

→ **Chlorination:**

When should this technique be used?

In an emergency case, such as for example a cholera outbreak in a village, chlorination is often the best solution to disinfect the drinking water because it is effective and fast to implement. Chlorine can also be used during the cleaning of the water supply infrastructures (pipe water network, well, reservoir...) or when water run inside a pipeline for the first time.

Principle:

Chlorine is a oxidant/disinfectant product which, when it is mixed with water:

- Destroy the pathogenic micro-organisms.
- Combine with other soluble or suspended substances (organic or mineral) present in water.

Warning!

- Chlorine is an effective disinfectant only if water was cleared beforehand from its suspended substances. Chlorination is ineffective on turbid water.
- With the proportion usually used, disinfection with chlorine is not very effective on the cysts (amoebas), on eggs of certain intestinal parasites, nor on the germs contained in the suspended substances.
- The only way to be sure of the effectiveness of chlorination is the measurement of the Free Residual Chlorine in water chlorinated. Free Residual Chlorine is the particles of chlorine that were not used to oxidize the oxydable substances of the water or

that did not combined with substances present in water (see picture 8). The chlorine odour and taste in water are not the proof of an effective chlorination.

- Metal destroying chlorine, chlorination should never be implemented in metallic containers, except if their inside walls were enamelled or painted.

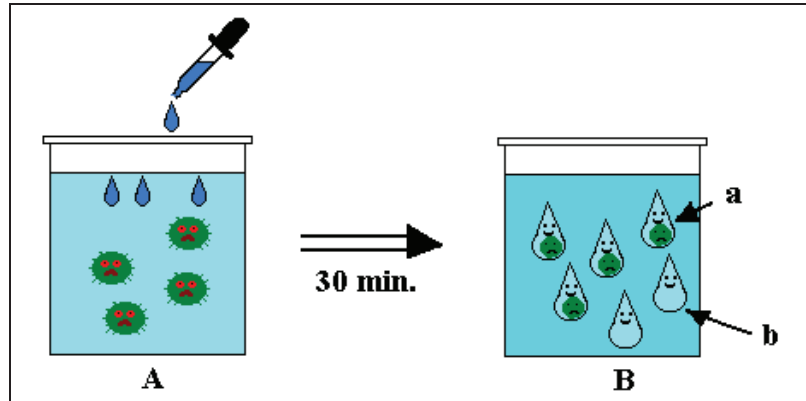

Fig.8: Free Residual Chlorine: sufficient amount of chlorine is added to contaminated water (A), after 30 minutes (B) water is healthy and contains “used” chlorine or compound (a), as well as Free Residual Chlorine (b).

There are several products generating chlorine (see table 11). The HTH is the product that should be used in priority: it can be stored for a long time (loss of only 2% per year of active chlorine) in a non-metallic airtight container, protected from the light and the heat. It is however very corrosive (in case of contact, rinse abundantly with water; to be handled with care). The HTH is subject to very strict norms on air transport and can be transported by air only in special containers.

Table 11: Products that generate chlorine

Product	Active Chlorine content	Notices
Calcium hypochlorite - HTH (High Tence Hypochlorite)	Powder at 70%	Should be used in priority for the collective treatment.
Sodium Dichloro-isocyanurate (NaDCC)	Powder at 60% Or 1.5 g/tablet	In tablet form, it allows an easy distribution at household level.
Sodium Hypochlorite solution, Javel water 12°C1 (or 15°C1)	4% (or 5%) liquid	Can be stored very little time after opening.
Chloramin T (chlonazone)	25% in tablet	Reserved for the individual use.

Implementation:

1. For the cleaning or for the first use of a pipeline network

- Calculate the total volume of the infrastructure that will receive water (reservoirs + header tank + break-pressure tank + pipe).
- Prepare a chlorine solution: in a recipient (a drum for example) that contains clear water, add 1 tablespoon of chlorine powder (or $\frac{1}{4}$ of litres of liquid chlorine) for each m3 of infrastructure to be cleaned. Shake well.

- Close the exit gatevalve of the first reservoir and let this reservoir get half-filled.
- Empty slowly the recipient containing the chlorine solution in the spring catchment.
- Once the reservoir is full, open the exit gatevalve, then open all the exit gatevalves at the tapstand level until chlorinated water flows.
- Close all the taps of the tapstands and wait 6 hours before using the water.

2. Well cleaning

If it is possible to empty the well:

- Prepare a chlorine solution: in a bucket of 12 litres full of water, put 1 tea-spoon of chlorine powder (or 4 tablespoons of liquid chlorine). Shake well.
- Empty the well and brush the well walls with chlorine solution.
- Wait 30 minutes then let the well get filled again.
- Wait 12 hours before using the water from the well.

If it is not possible to empty the well:

- Calculate the volume of water contained in the well:
 $V \text{ (m}^3\text{)} = 3.14 \times \text{radius (m) of well} \times \text{radius (m) of well} \times \text{height (m) of water in the well.}$
- Prepare a chlorine solution: in a recipient that contains water, put 10 tablespoons of chlorine powder (or 2.5 litres of liquid chlorine) for each m³ of water contained in the well. Shake well.
- Pour the chlorine solution in the well and shake the water.
- If the well is equipped with a pump, pump water until chlorinated water flow out of the pump.
- Wait 12 hours before being taking water in the well.

Advantages:

- Effective and fast treatment to implement.
- Allows destroying the pathogenic organisms present in water and protect water against new contaminations during transportation or storage.

Disadvantages:

- Procedure limited to clear water. If water is turbid it is necessary to pre-treat water (decantation, flocculation...) before being able to carry out chlorination.

→ Slow sand filtration

When should this technique be used?

This process allows a treatment of organic pollution (faecal) of rather clear water (NTU < 20).

Principle:

This process consists in making water pass through a layer of sand; during this operation, water quality improves due to two main phenomena:

- A mechanical filtration by the sand which allows retaining the suspended particles,

- Biological action which eliminates all the pathogenic bacteria and a part of the viruses. This action is possible due to the growth of large variety of micro-organisms in the first centimetres sand thickness. These organisms form what is called a biological membrane (or biofilm) that has the characteristic to degrade the organic substances such as pathogenic germs.

Warning!

The organisms forming the biofilm develop only under certain conditions which should be observed to ensure a good effectiveness of the system:

- The biofilm must always be under water (never let the level water going down lower than the sand).
- The water supply must be slow (do not filter more than 200 litres per m² of filtering surface per hour).
- The water supply must be as much as possible continuous (to maintain a continuous flow through the filter by controlling the debit with a tap).

If these conditions are met, one or two weeks are necessary for the biological membrane to develop and for the filter to become effective.

Implementation:

Use for example a plastic container of 200 litres (which did not contain chemicals before).

Put in the bottom a layer of 10 to 15 cm of clean gravel which granulometry ranges between 1.5 and 5 centimeters.

Put above the gravel a 75 cm thick layer of (clean!) sand presenting a granulometry ranging between 0.2 and 0.5 millimetres. When the filter is completed, fill the container with a chlorine solution of 100 mg/l and wait until 12 hours before emptying and rinsing. The filter can then be put in function directly, but its maximum efficiency (biological action) will be effective only after 1 to 2 weeks.

Advantages:

- Efficient physical and biological treatment.

Disadvantages:

- Process difficult to implement and which requires a lot of care and monitoring.
- Can not be used for very turbid water (the filter will clog itself if NTU > 20).

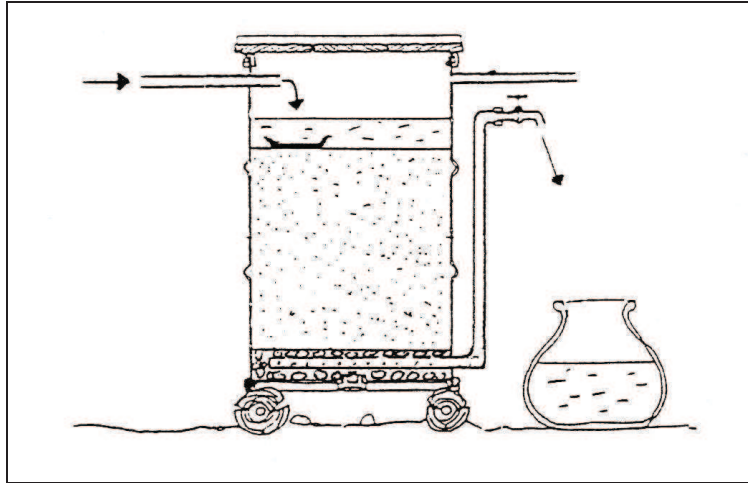

Fig.9: An example of simple design of slow sand filters

→ **Boiling**

When should this technique be used?

Boiling is an effective process of disinfection of water, which works even on turbid water. This method presents nevertheless serious disadvantages, which limit its use to the situations where no other technique is possible.

Principle:

The pathogens can not survive for long at high temperature: boiling the water allows destroying all pathogens it contains.

Implementation:

Bring water at complete boiling and prolong boiling for about 2 minutes.

Advantages:

Good efficiency, even if water is very polluted or very turbid

Disadvantages:

- Boiling can necessitate a lot of combustible. For example, 1 kg of wood is needed in average to boil 1 litre of water.
- For the disinfection to be fully effective, the boiling should be prolonged for several minutes.
- Unlike chlorination with Free Residual Chlorine, there is no prolongation of the disinfecting effect of boiling water, and it can be easily re-contaminated after the boiling is finished.

→ **Ozonization or treatment by ultra-violets (UV) ray**

When should this technique be used?

It can be used as a final treatment of water reserved for human consumption. In many countries of South-East Asia, the water treatment by ozonization and/or ultraviolet ray is largely used by the companies which produce drinking water bottles. Because of its costs and complexity, these water disinfection techniques are not adapted to the water treatment in rural areas.

Principle:

Ozone (O₃) is a gas with strong odour. The ultraviolet rays (UV) are radiations invisible to the human eye. Like chlorine, these two products destroy the micro-organisms present in water.

Implementation:

Ozonization: First, it is necessary to produce ozone from oxygen. Ozone is then put in contact with water to be treated in basins equipped with ozone spreader.

Ultraviolet ray: Water is treated in basins equipped with ultraviolet lamps.

Advantages:

- Effective disinfection of water.

Disadvantages:

- High costs in term of both material purchase and process implementation (especially for ozonization).
- Complexity of the operation, requiring permanent electricity supply.
- Procedure restricted to clear waters. In case water is turbid, it is necessary to pre-treat it before being able to do the ozonization or ultra-violets treatment.
- Unlike chlorination, there is no prolongation of disinfecting effect in water.

→ The removal of iron and manganese

When should this technique be used?

For water containing iron or manganese. Generally, this treatment, based on aeration, allows eliminating the bad smell and the specific taste from water containing iron and/or manganese.

Principle:

Precipitation through aeration (oxidation) of dissolved iron or manganese contained in the water. The precipitates formed can then be eliminated by simple decantation or, better, filtration.

Implementation:

Three examples of iron treatment by ventilation and filtration are given on pictures 10 and 11. This type of filters installed by ACF in Cambodia allowed reducing the iron concentrations of borehole water of initial 3-15 mg/l to values lower than 0.3 mg/l.

Advantages:

- Effective elimination of iron and manganese present in water.

Disadvantages:

- Difficult to implement.
- Process requesting follow-up.

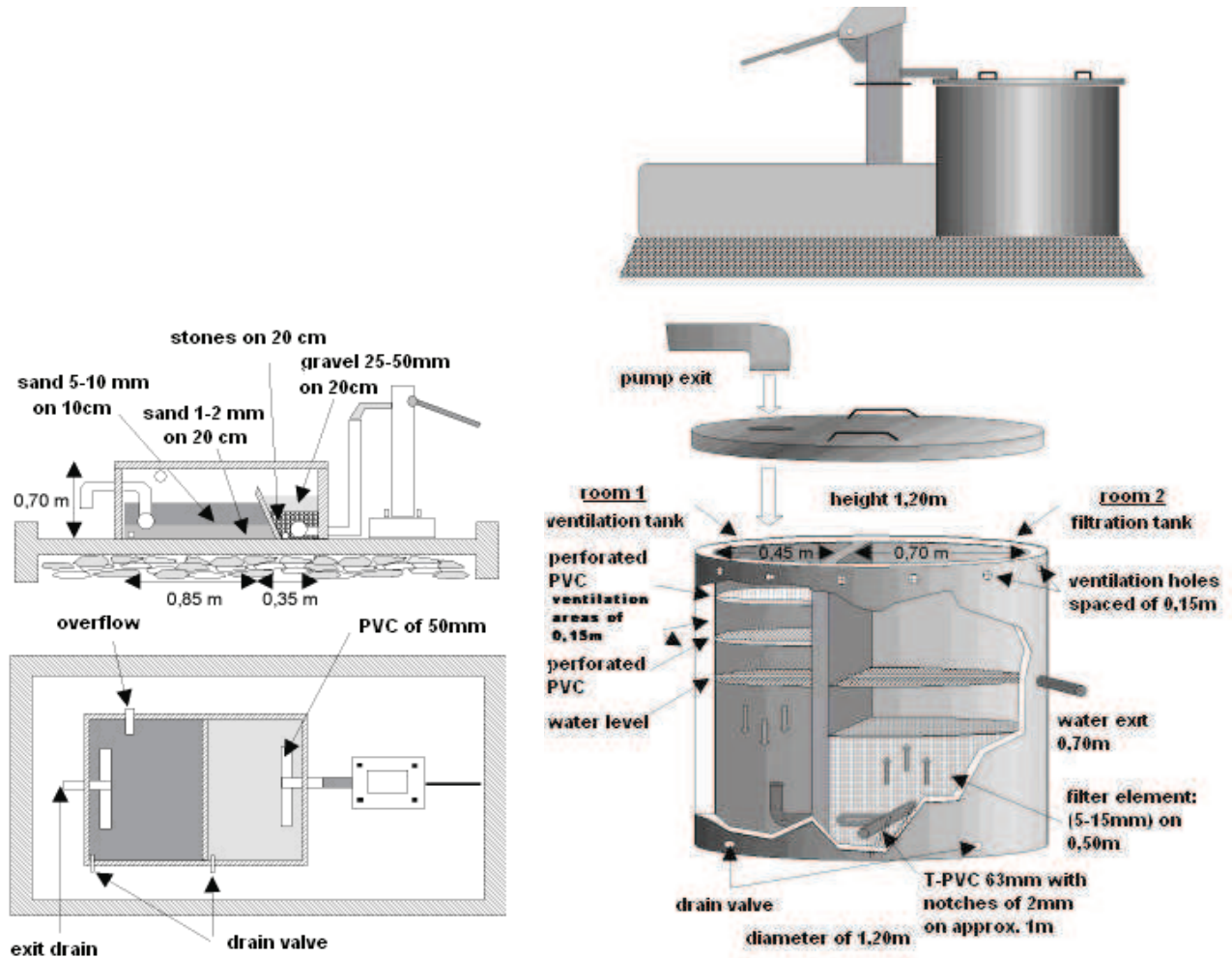

Fig.10: Two examples of iron and manganese treatment by aeration and filtration.

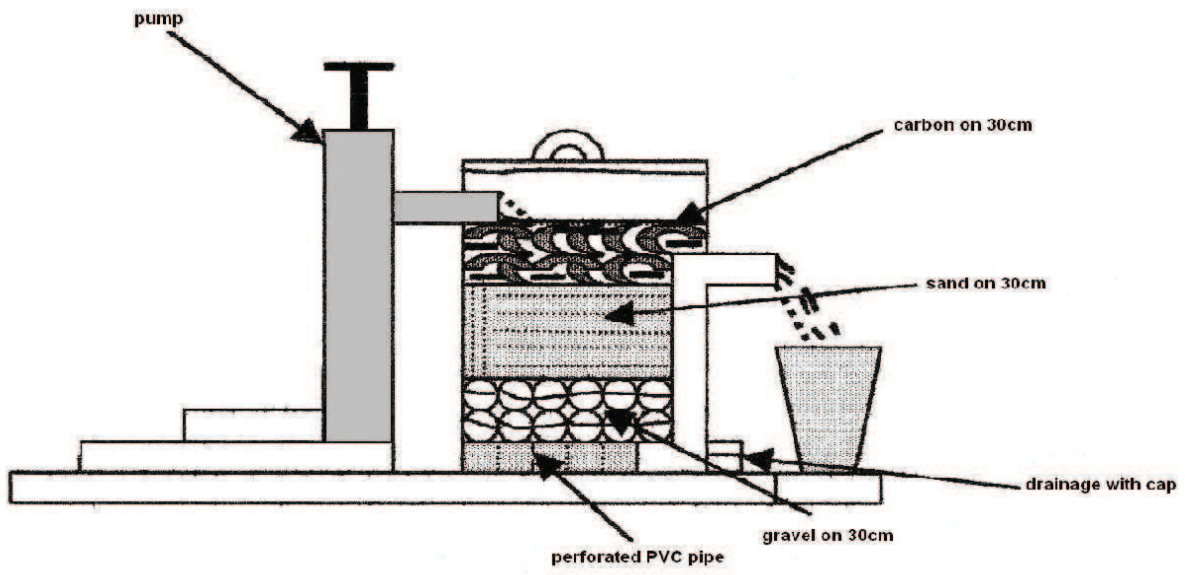

Fig.11: Examples of iron and manganese treatment used by ACF

II. WATER SUPPLY

II.1. WHAT ARE THE DIFFERENT WATER SUPPLY TECHNOLOGIES?

The type of water appropriate for the water supply are:

- Rainwater.
- Surface water: streams, river, lake, pond.
- Groundwater.

II.1.1. Rainwater

The use of rainwater is a common technique in many countries.

The rainwater is collected on an equipped surface (generally the roof of a house) and is brought by gutters in a storage reservoir.

This technique of water supply can prove to be interesting in certain areas, either where it rains a lot, either very dry when the water resources are very scarce and any source of water should be used. Because of the great storage volumes required, this technique is used as a temporary resource in complement to others.

In all cases, the main disadvantage of this water resource comes from the quality of water, polluted and charged with sediment during the filling (roof dusty or covered with animal excrements for example), and contaminated after a long period of storage. Moreover, the lack of minerals makes rainwater (often acid) corrosive towards metals (because no limestone is present to neutralize acidity), and if the rainwater is the only source of drinking water for the population, it might be necessary to add minerals to the food (iodine for example...) to compensate their absence in the drinking water.

An example of rainwater collection is given on picture 12.

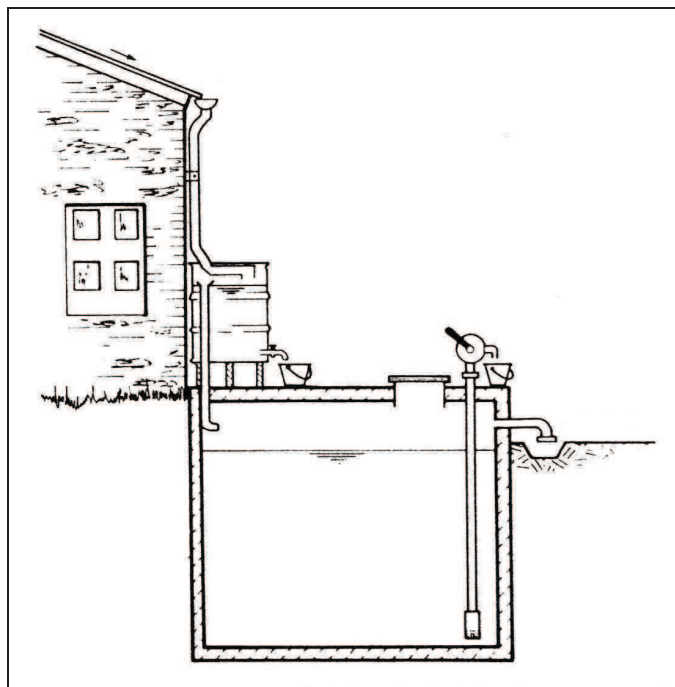

Fig.12: Rainwater collection through the home roof.

II.1.2. Surface Water

Surface water has the advantage to be usually easily accessible (ponds, lakes, rivers); near of the people's living place, but unfortunately this water is extremely vulnerable to pollution (suspended substances, pathogens). Some of the surface water points can dry out in dry season. Surface water sources are varied and it exists numerous ways to use them.

- Direct intake from the river

Simple and quick solution which requires a minimum level of infrastructures: creation of catchment areas along the river according to the different use made of the water (washing, bathing...see picture 13). Upstream of all other activities, a zone will be reserved to fetch water for human consumption.

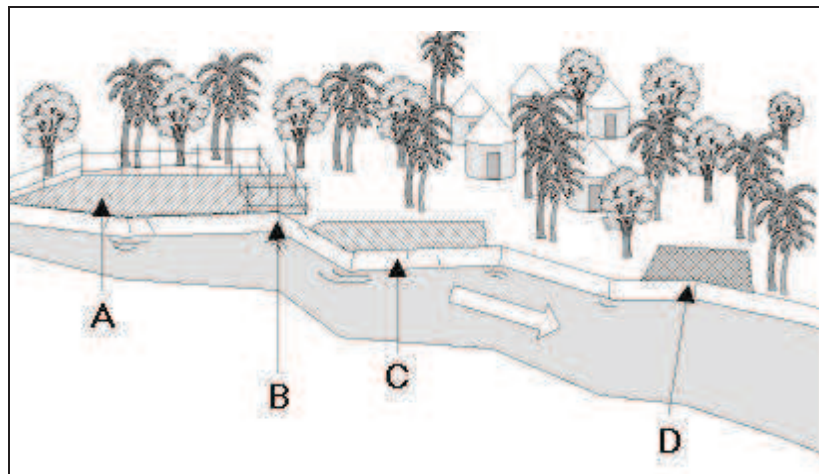

Fig.13: Example of water fetching point along the river (A: closed perimeter in an upstream part to fetch water for domestic usage, B: protected access to this perimeter (for example chicane access), C: zone for washing and bathing, D: downstream zone reserved for the animals).

- Direct river catchments

Rivers catchments are done through a pipe equipped with an inlet filter connected to a pump. Water is pumped in a reservoir then distributed through a distribution network. A water treatment will always be necessary given all the possible risks of pollution.

The yield which it is possible to pump depends on the type of pump, the population to be served and the river flow (average yield along the year, taken into account also the lowest yield, i.e. dry season).

The catchments should be done upstream of the populations living place, where risks of pollution are lower. It is necessary to clean river banks on a certain distance and a dam/reservoir can be necessary to stabilize a river if this one has an irregular flow.

An example of direct rivers catchment is given in picture 14.

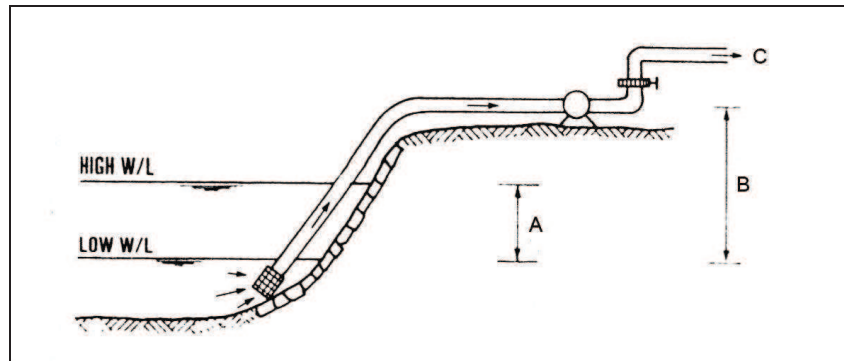

Fig.14: Example of direct river catchments.

A: variation between the highest and the lowest level (W/L=water level) of the river,
 B: suction height limited by the type of pump used, C: leading to a reservoir /
 treatment unit.

- Indirect river catchments

It is possible to improve the quality of river water by using as a natural filter the alluvium layer often located under the bedrock: infiltration well, bottom filters, and infiltration galleries or even a borehole drilled in the alluvium. An example of indirect river catchments of is given in the picture 15.

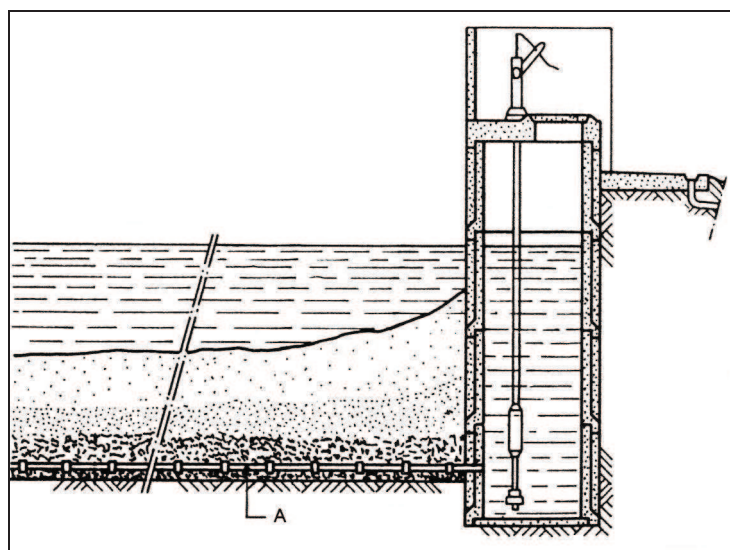

Fig.15: Indirect river catchments with the support of drainpipes (A) laid horizontally under the river bed.

- Catchments from a lake or from a dam

When a stagnant water (or still water) is in good conditions, it presents the best resource for surface water. Indeed, if the water duration stay is long enough, harmful substances either settle in the bottom of the lake/pond, or accumulate at the surface, or can also oxidize and then settle down.

The catchment should not be too deep, so that the water caught is clear and oxygenated enough, and should not be too shallow, so that water does not contain too much organic substances (indeed, organic substances often develop near the water surface where more sunlight is available).

Ideally, the depth of the catchment should be between 10 and 20 m. One must take care that the water resource does not contain any wastewater.

II.1.3. Groundwater

Groundwater presents in general a good bacteriological quality, due to their long decantation and auto-purifying properties of the ground. They are therefore often appropriate for consumption: in that case, the treatment will not be necessary. The deeper the catchment is, the better the quality of water will be. However, they can also present mineral pollutions, emanating from the rocks dissolved by water in the ground (notably iron, sodium chloride, calcium, magnesium and fluorine).

Moreover, rocks present in a crystalline ground can present cracks and can therefore contain groundwater polluted by direct transfer of surface pollutions in the cracks (absence of usual filtration process by the soil). In addition, any groundwater located at a depth lower than 3 m is considered to be surface water.

- Spring catchment

A spring is a natural flow of a groundwater reserve in the open air. It is the easiest way to use groundwater. The objective of a spring catchment is to use at best the spring flow, while protecting it from outside pollutions, especially from faecal origin. Every spring catchment is a particular case: it is therefore not possible to offer an example adapted to all situations. They can however be classified in two types: reinforced concrete catchments box, or buried drains. An example of spring catchments is given in the picture 16: the catchment is made by the mean of a drain; once collected by the drain, water goes directly to a header tank.

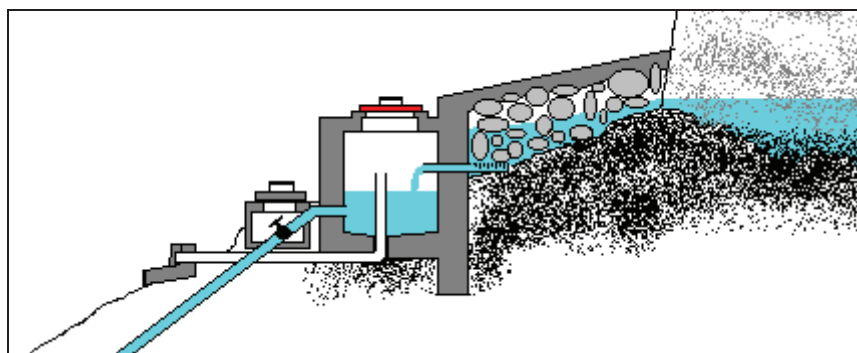

Fig.16: Example of spring catchment

- Hand Dug Well

A well is an infrastructure dug manually, which collects a moderately deep or deep aquifer. Its depth and diameter vary according to the context. Generally speaking, the diameter of a

well is from 1 to 2 meters and its depth does not exceed 25 to 30 meters. After this depth, work is very dangerous and expensive.

The most important parts of a well in terms of water quality are the surface infrastructures, which protects it from of surface water infiltrations and facilitates the water access and use. The surface infrastructures are designed to:

- drain surface water towards the outside perimeter of the well (construction of apron, drainage channel, soakage pit)
- limit the risks of falls of the well users inside the well (well head)
- limit the access of the animals (well fence, well head)
- Limit the pollution of the well water during the fetching operation (cover slab, well head, well door, pumping system). Ensure that the well head is low enough to be accessed by children, and the door can be opened by them also.

An example of properly built well is given in picture 17:

- A: Drainage ditch that prevents stagnant water and allows the surrounding of the well to stay clean.
- B: Apron which avoids the formation of muddy land and prevents the infiltration of water along the well lining. The apron must be built with a sufficient slope so that stagnant water can be easily evacuated.
- C: Pumping system appropriate for all the users (manual or electric pump, pulley, winch...).
- D: Fence which prevents the well access to the animals.
- E: Sealed lining on the first three meters to prevent surface water to infiltrate in the well.
- F: Water catchment area that must be always inside water and clean

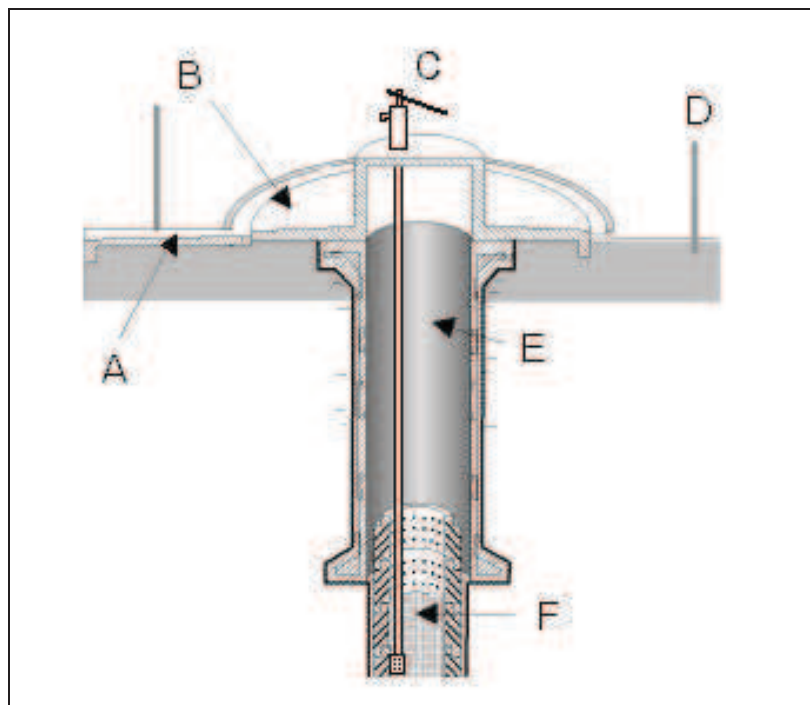

Fig.17: Example of a properly built well (A: drainage, B: apron, C: pumping system, D: fence, E: lining, F: water catchment part).

- Borehole

A borehole is deep ground water catchment. It consists of a long-narrow tube inserted in the ground by the mean of a drilling machine. Its usual diameter is 10 to 20 cm. The drilling of a borehole requires most of the time the intervention of a drilling machine (expensive!). However, manual drilling, at low cost, under good conditions, can reach 60 m of depth. Borehole must be equipped with a pump (powered by hand or not) and with roughly the same surface infrastructure than a hand dug well (reinforced concrete apron, drainage ditch and fence which prevents the access to the animals). A standard example of borehole is given on picture 18.

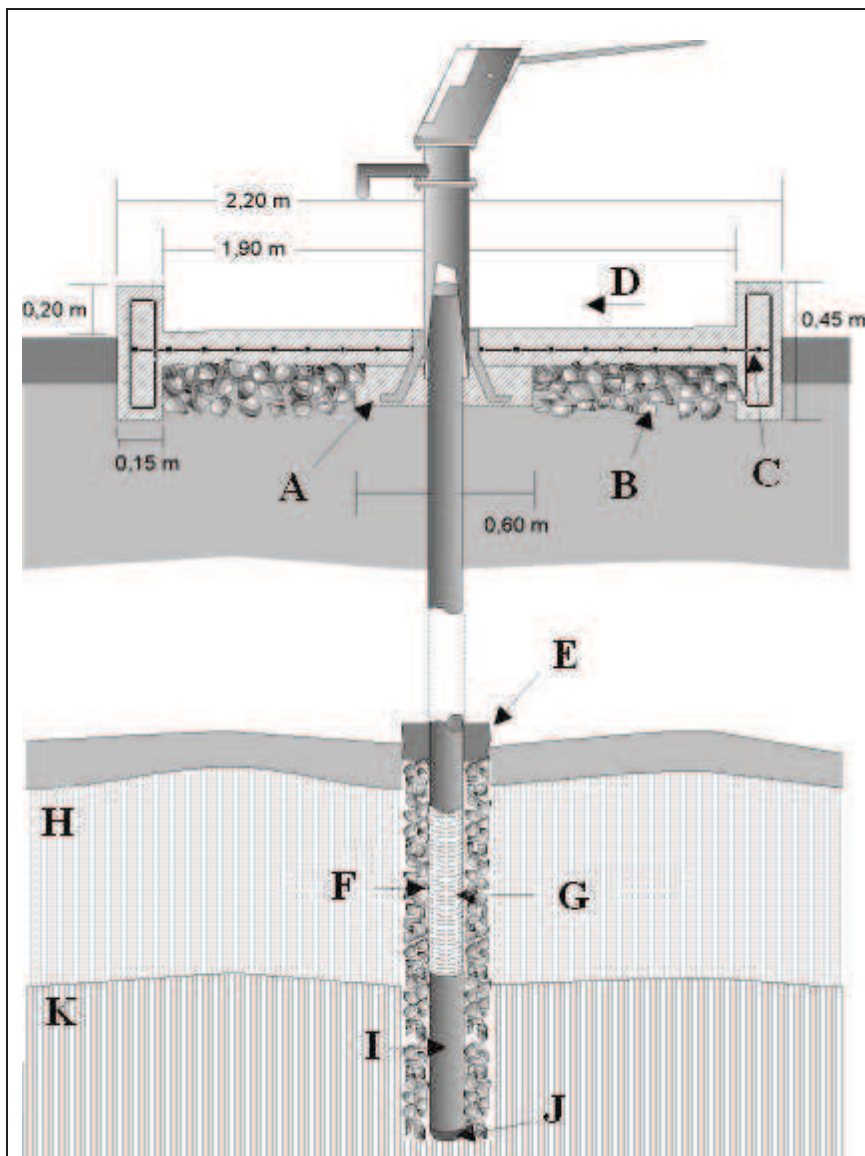
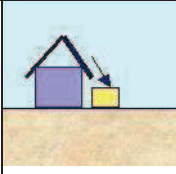
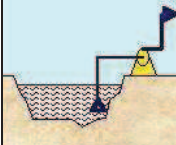
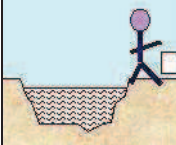
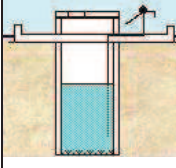
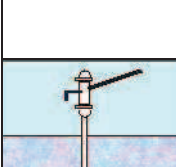



Fig.18: Cross section of an equipped borehole (A: hand pump concrete anchoring, b: stone foundation, C: iron bars, D: slope of 2% to allow drainage, E: cement plug, F: gravel filter, G: filter pipe (screen), H: aquifer, I: PVC sedimentation tube, J: bottom plug, K: substratum = bedrock).

II.1.4. Advantages and disadvantages of various technologies of water supply

The features of the various water supply technologies developed above are given in table 12.

Table 12: Characteristics of various water supply technologies

Water resources	Water supply technology	Water supply system	Advantages	Disadvantages	
Rainwater		Rainwater collection	Reservoir with tap	- Good bacteriological quality if collected under good conditions.	-Temporary or complementary resource. -Not containing minerals and can be easily polluted
		River or lake intake	Pumps, reservoir and taps	- Rapid to implement	-Requires generally a treatment unit. -Requires a pump to lift the water.
Surface water		Direct river intake	None, or very simple (bucket, jerrican)	Easy and quick to implement	- High probability of faecal pollution - Water can be very turbid
		Hand dug wells	Pump (powered by hand or not), pulley, bucket...	- Clear water and good bacteriological quality if well is deep and well protected.	-Can request a lot of work for the digging/construction (especially for deep wells). -Water can be easily contaminated if well badly protected.
Groundwater > 3 meters		Borehole	Pump (powered by hand or not)	- Clear water and good bacteriological quality. - Allows deep water catchments.	- Request a lot of work for the construction -Borehole cost can be very high.
		Spring catchments	Gravity Fed System and tapstand	- Clear water and good bacteriological quality. - Easy to use.	- Flow is not always sufficient to cover population water needs.

II.2. HOW TO CHOOSE THE MOST SUITABLE WATER RESOURCE?

To choose the most suitable water resources it is necessary to take into account several factors such as:

- Technical Criteria:
 - Operation costs.
 - Complexity of the commissioning and the maintenance (required people?).
 - Spare parts availability on the local market?
 - Use of local or imported materials?

- Environmental Criteria:
 - Water quality.
 - Potential contaminations.

- Community Criteria:
 - Organization capacity and motivation.
 - Financial capacity to pay for the maintenance of the infrastructures.
 - Technical skills availability within the community.

- Institutional Criteria:
 - Design and model validated by the national policy and relevant ministries
 - Capacity of the local authorities to assist the community.
 - Available technical assistance and follow-up.
 - Available budget.

The choice must go for the most durable solution. It is obvious that the maintenance of the installation in the medium and long term plays an important role in the choice of the resource, and particularly the type of installation envisaged which will have to be managed with by the users. It is necessary to avoid the construction of a pumping or treatment station that nobody will be able to operate (because of the high price of the consumable like fuel, spare parts, maintenance, or because the full understanding of the system not possible for the community due to their low education level).

For the drinking water, groundwater resources should be chosen in priority, when they are accessible, as compared to surface water source, river or lake, for quality and cost reasons. The realization of a gravity fed system based on a spring catchment is an interesting solution, because it allows having a groundwater available with minimal operation costs.

It is thus preferable to choose firstly (see picture 19):

1. Spring catchments with gravity fed network.
2. Deep groundwater (well and boreholes of at least 10 meters deep).
3. Medium-deep groundwater (well and boreholes from 3 to 10 meters of depth).
4. Surface water.

The order of priorities quoted above is to be respected in the majority of the cases. It is necessary however to use one's common sense for the choice of the water resource and it is possible that situation will occur where this priorities order must be reversed. For example, if there is near a village a groundwater rich in arsenic and a river not contaminated by upstream industries, the river should be used as water resource. Indeed, although potentially contaminated by pathogens, the river offers better quality water from a chemical point of view (absence of toxic pollutant).

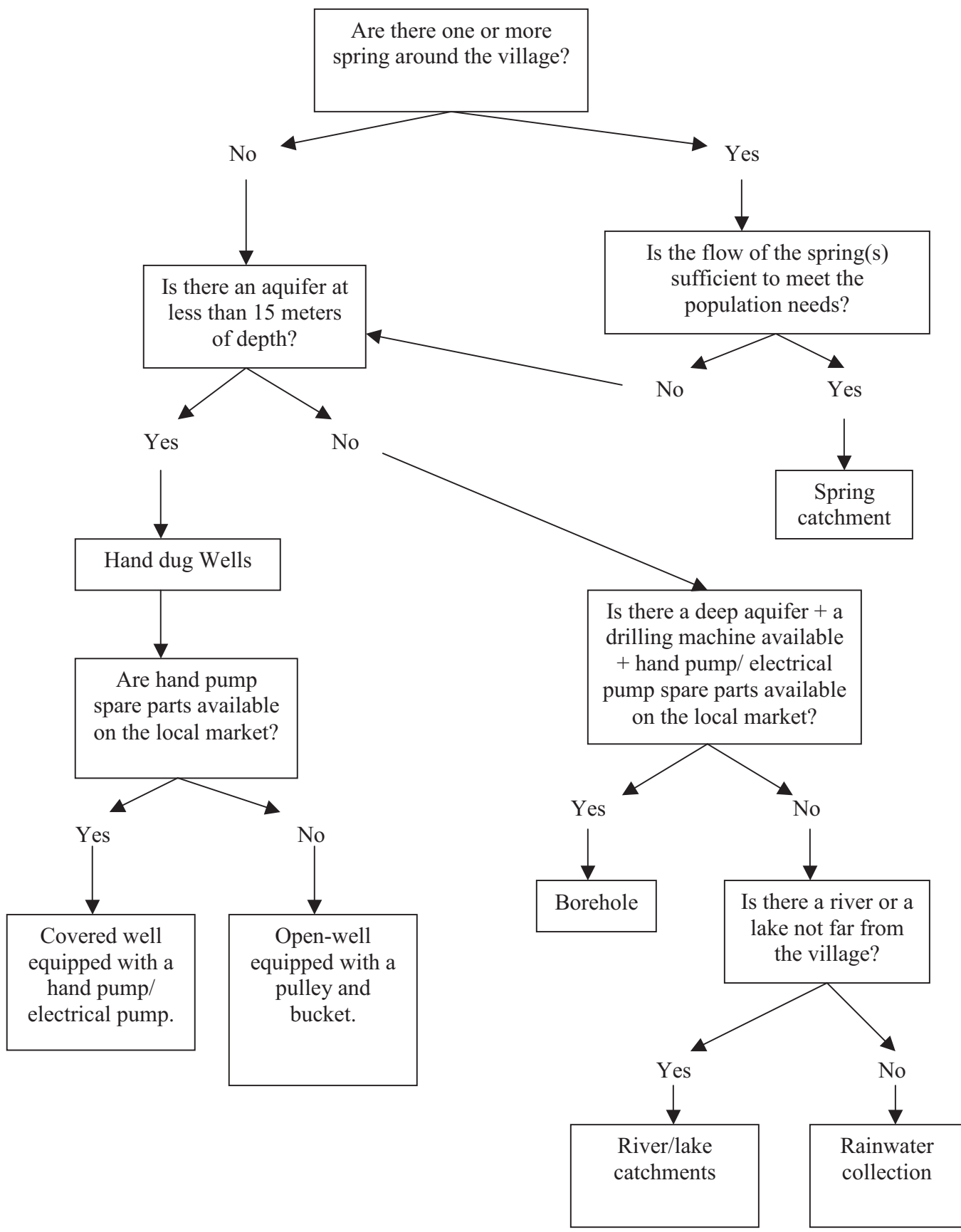

Fig.19: Water resource choice.

II.3. WHAT CAN BE THE EFFECT OF DEFORESTATION ON GROUNDWATER RESOURCES?

All plants (trees, bushes, etc) contribute to the creation and stabilization of the soil. When the vegetable cover that protects the soil is removed from it, consequences are catastrophic: the soil loses its fertility and groundwater resources disappear.

The deforestation effects are illustrated in the picture 20:

1. Thanks to their roots, plants protect the soil from erosions and facilitate the infiltration of surface water inside the ground, thus decreasing the ground surface run-off.
2. When plants are removed from the surface of the ground, the soil is naked and exposed to all erosion processes: the entire fertile soil layer disappears, washed away by strong rains. Water is not retained any more and instead of infiltrating in the ground it runs on the surface, sweeping away everything on its way, causing floods in the downstream valleys. The bedrock is gradually exposed.
3. It remains nothing any more but the bedrock. No more culture are possible. The place became desert and without water.

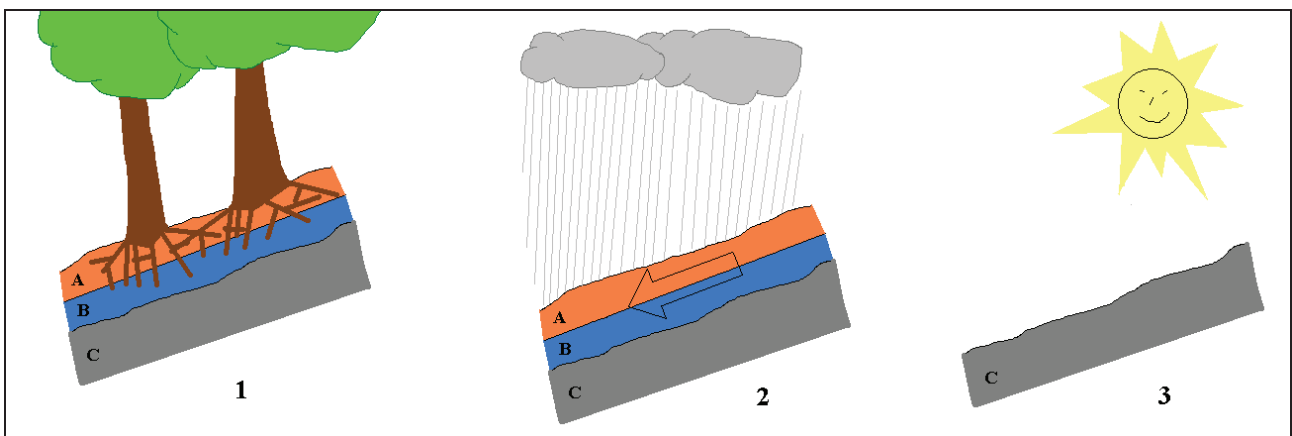

Fig.20: Deforestation effects of (A: soil, B: groundwater and C: rock layer).

In many countries deforestation has harmful effects on agriculture and the country long-term economy. Two examples are given here:

- In China 25% of the land lost their fertility because of massive deforestation. Moreover, each year, 2.5 billion tones of loess (very fertile yellow ground) is lost and carried to the sea by the Huang He river.
- In Haiti (a Caribbean mountainous island), springs have less and less water because of continuous deforestation. People are today obliged to walk several kilometers to look for water to the rare springs which remain.

The picture 21 gives another example of the effect of deforestation:

- A: The upstream vegetable cover efficiently protects the grounds and the groundwater. There is water in the well.
- B: Trees were cut and the grounds washed away by erosion. The downstream aquifer is not supplied any more and, as a result, there is no more water in the well.

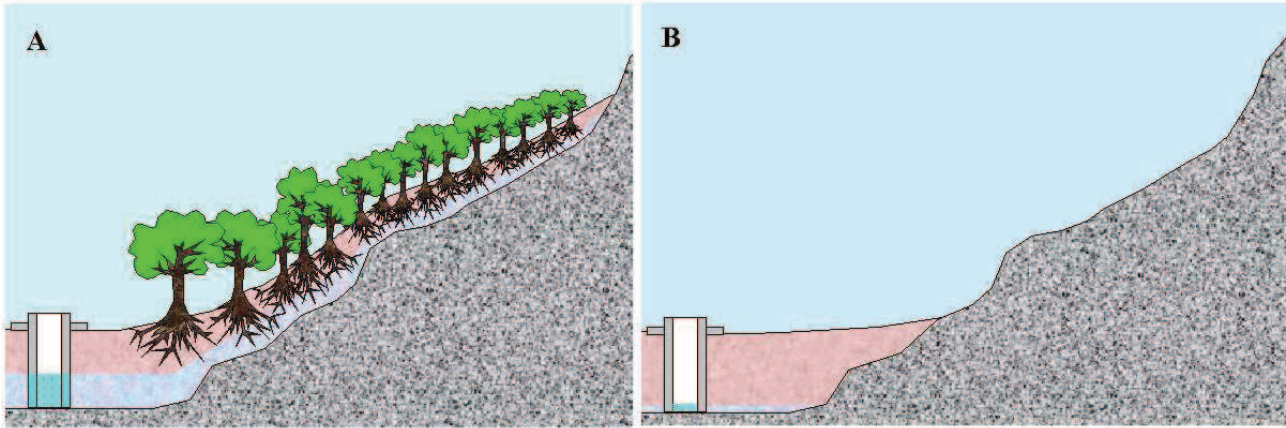

Fig.21: Deforestation effects on a well located downstream from a forest.